

# Quick Installation Guide

---

- ☑ MTG200
- ☑ MTG1000B
- ☑ MTG2000B
- ☑ MTG2000

## Thanks for Choosing Dinstar's Trunk Gateway!

Please read this guide carefully before installing the gateway. If you need any technical support, please contact us.

Tel: +86 755 61919966

Email: [support@dinstar.com](mailto:support@dinstar.com)

Website: [www.dinstar.com](http://www.dinstar.com)

# 1 Product Model & Number of E1/T1 Ports

Model \ E1/T1 Port	1	2	4	8	12	16	20
MTG200	✓	✓	✓				
MTG1000B	✓	✓	✓				
MTG2000B			✓	✓	✓	✓	
MTG2000			✓	✓	✓	✓	✓

Note: the number of E1/T1 ports of MTG2000 is determined by the number of inserted DTU boards. Each DTU board has four E1/T1 ports.

# 2 Description of Indicators

Indicator	Definition	Status	Description
PWR	Power Indicator	On	The gateway is powered on
		Off	The gateway has no power input or power supply is abnormal
RUN	Running Indicator	Slow Flashing	The gateway is running properly
		Off	The gateway is initiated improperly
E1/T1	E1/T1 In-use Indicator	On	E1/T1 port is connected properly.
		Off	E1/T1 port is faulty or not connected
		Flashing	Physical connection of E1/T1 is abnormal or there are error codes in E1/T1 circuit.
GE	Network Link Indicator	Fast Flashing	The gateway is properly connected to network
		Off	The gateway is not connected to network or network connection is improper
	Network Speed Indicator	On	Work at 1000Mbps
		Off	network speed lower than 1000Mbps

### 3 Indicators & Interfaces

#### ▶ MTG200

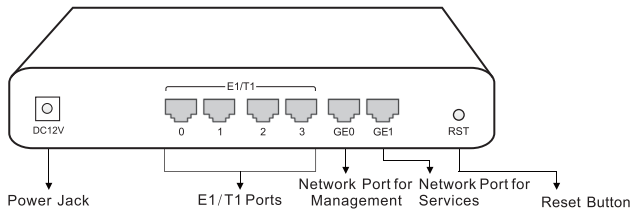
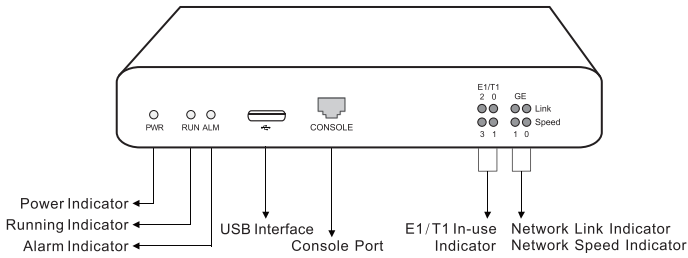

#### ▶ MTG1000B

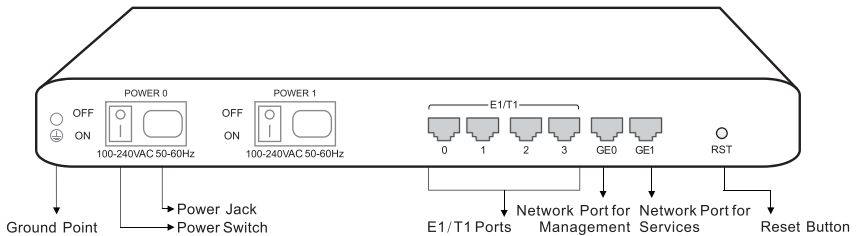
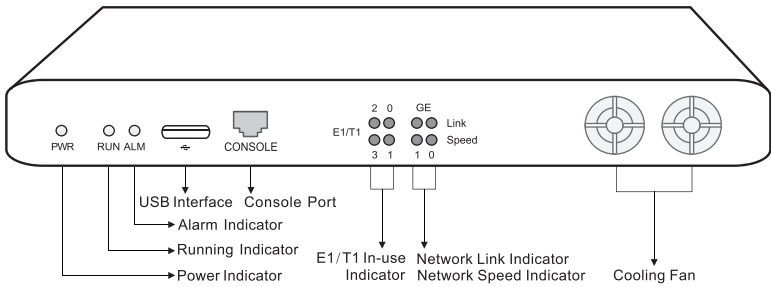

## ▶ MTG2000B

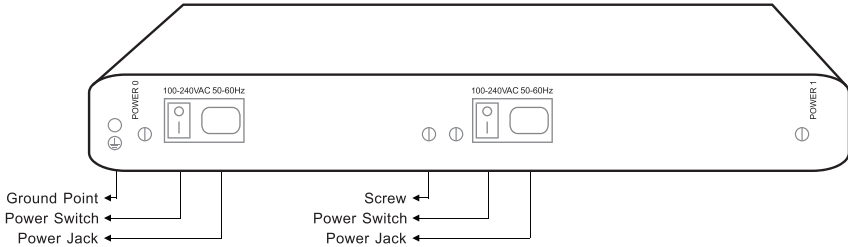
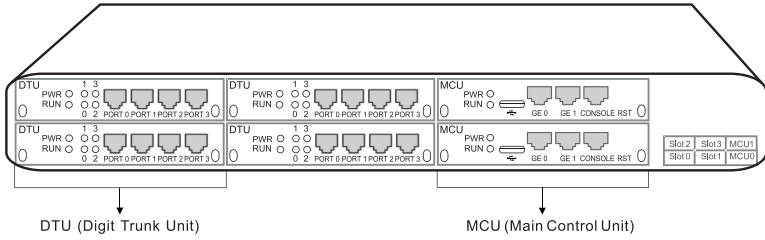

### • DTU(Digit Control Unit)

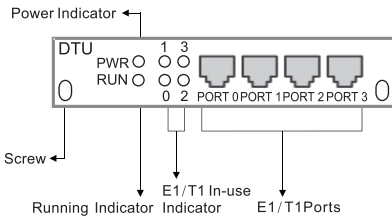

### • MCU(Main Control Unit)

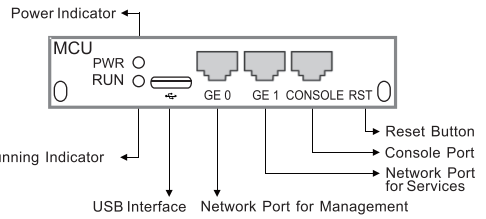

## ▶ MTG2000

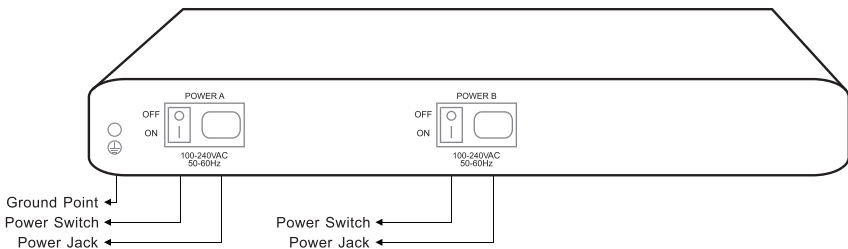
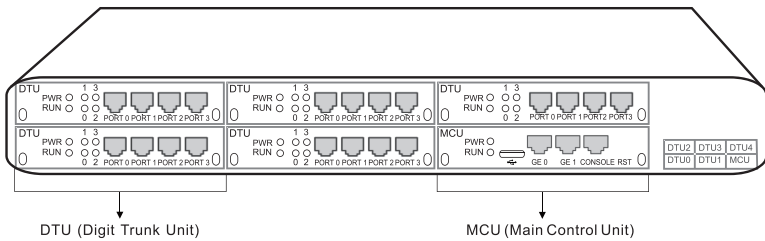

• DTU(Digit Control Unit)

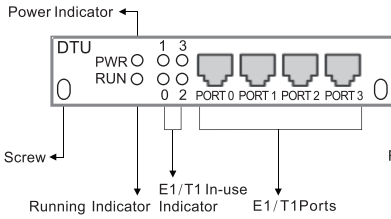

• MCU(Main Control Unit)

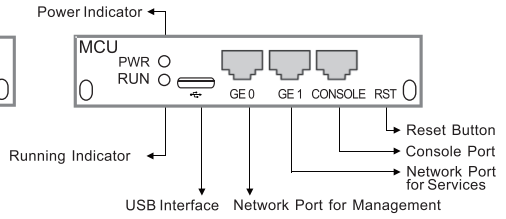

## 4 Installation Instructions

- ◆ Cabinet requirement: ensure the cabinet to accommodate MTG1000B/MTG2000(B) is well ventilated and strong enough to bear the weight of the device. It's required that the width of the cabinet be 482.6mm (19 inches);
- ◆ ESD protection: please wear anti-static wrist strap when installing MTG1000B/MTG2000(B) ;
- ◆ Power supply: MTG200 accepts DC 12V power input, while other MTG models accept AC voltage of 100-240 V. It's recommended that users use UPS (uninterruptible power system).
- ◆ Device grounding: please ensure the gateway is properly grounded. To avoid interference with power source, it's recommended that the earth resistance be less than 2Ω;
- ◆ Temperature and humidity: to avoid any accident that might cause malfunction, it's advised to install the gateway in an equipment room where temperature and humidity are appropriate; the equipment room should be clean and ventilated enough to facilitate heat dissipation;
- ◆ Anti-jamming: to reduce interference, please keep MTG devices away from high-powered transmitter, radar transmitting station and large-current devices .

## 5 Installation Instructions

### ▶ Connection Diagram for MTG200

• Connect Gateway with Ethernet

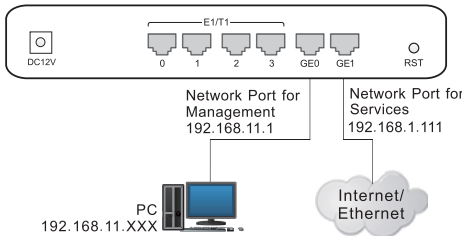

• Connect Gateway with Power

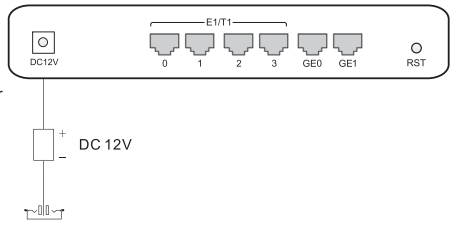

• Connect E1/T1 Port with PSTN/PBX

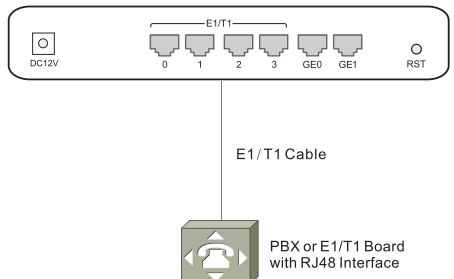
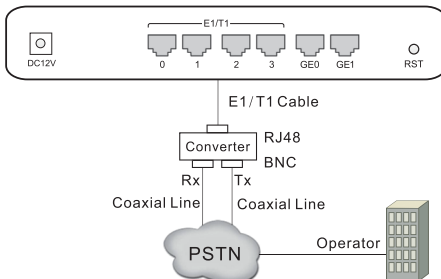

## ► Connection Diagram for MTG1000B

### • Connect Gateway with Ethernet

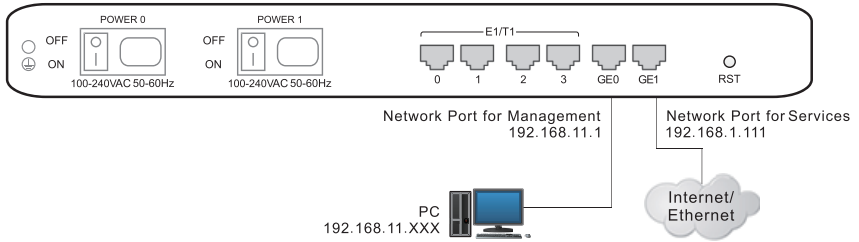

### • Connect E1/T1 Port with PSTN/PBX

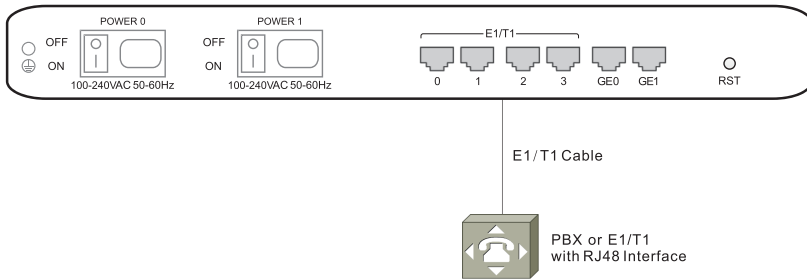
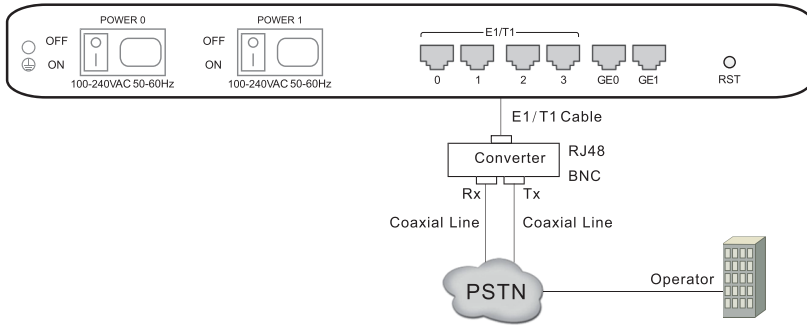

### • Connect gateway with power input and ground point

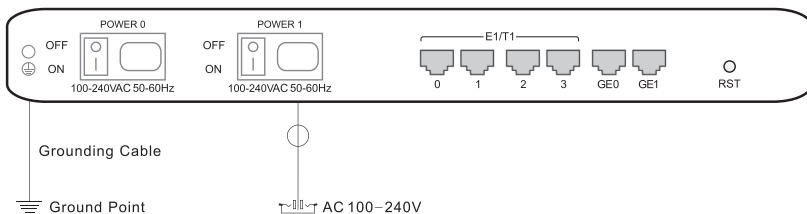

## ► Connection Diagram for MTG2000B

### • Conenct Gateway with Ethernet

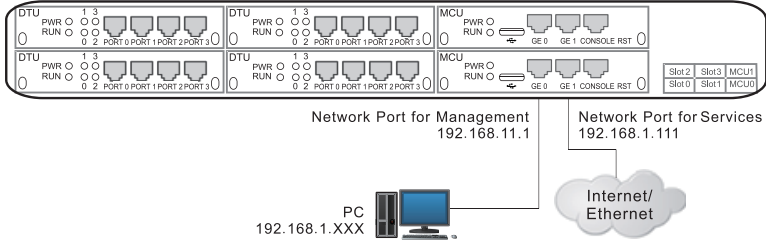

### • Connect E1 / T1 Port with PSTN/PBX

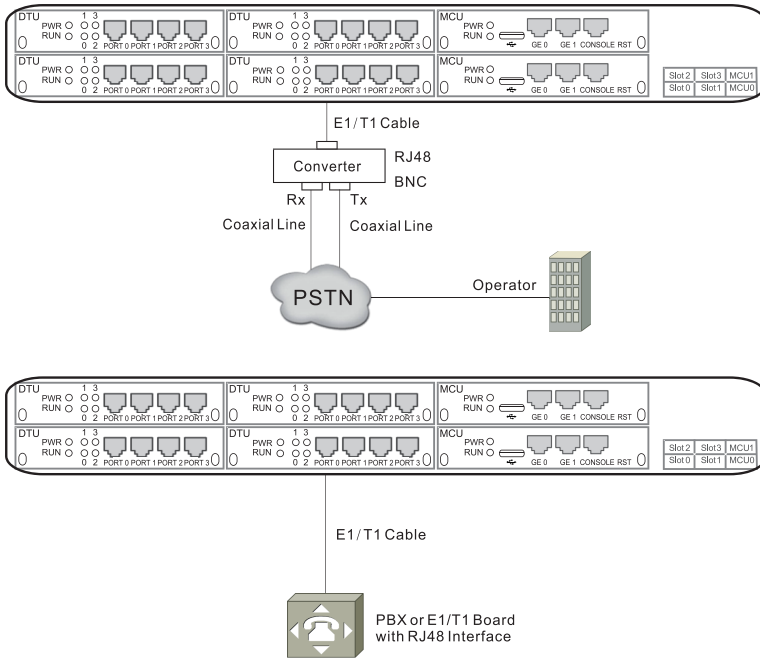

### • Connect gateway with power input and ground point

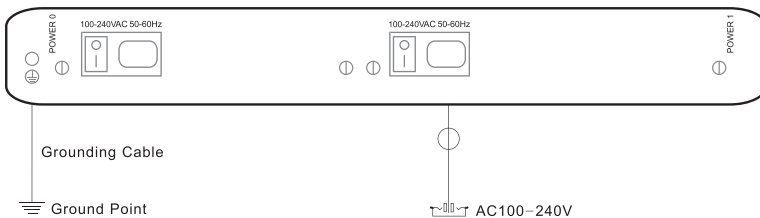

## ► Connection Diagram for MTG2000

- Connect Gateway with Ethernet

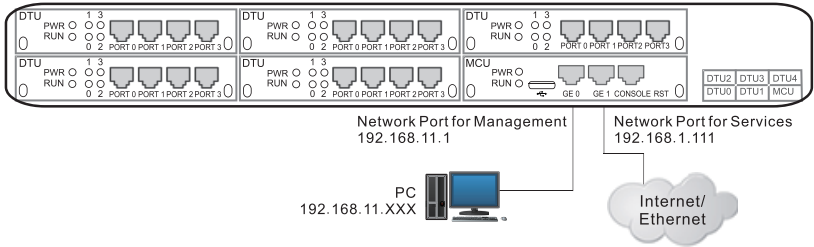

- Connect E1/T1 Port with PSTN/PBX

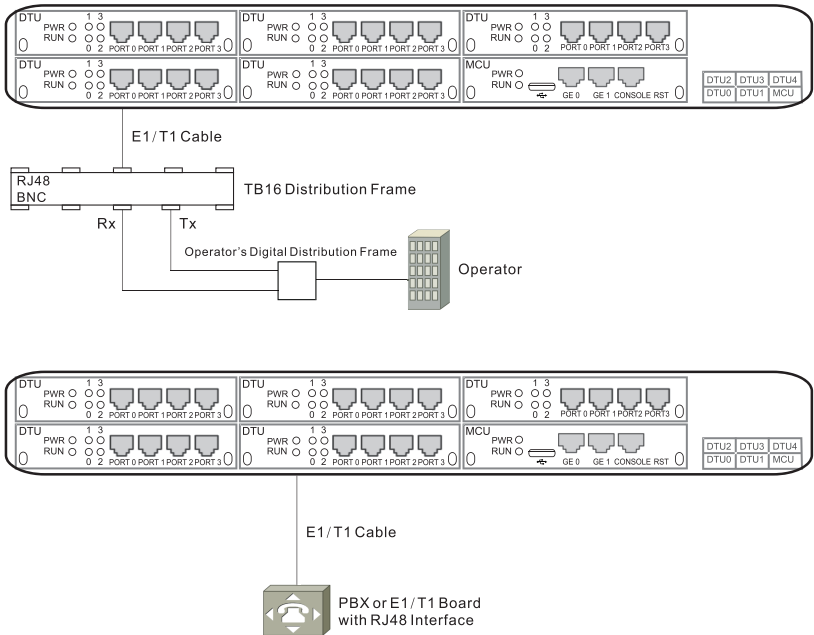

- Connect gateway with power input and ground point

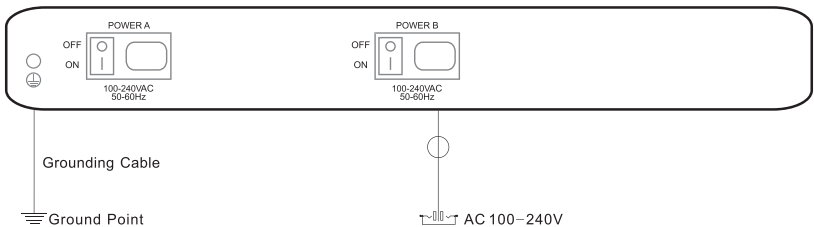



## 6 Wire Sequence of RJ48(E1/T1) Cable

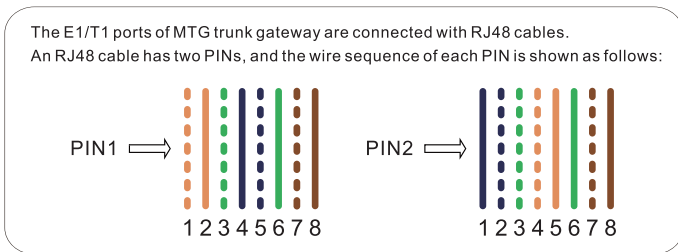

PIN1: orange & white, orange, green & white, blue, blue & white, green, brown & white, brown.

PIN2: blue, blue & white, green & white, orange & white, orange, green, brown & white, brown.

## 7 Modify PC's IP Address

To log in the Web Management System of the trunk gateway, you need to modify the IP address of PC first to make it at the same network segment with the gateway. Connect PC with the gateway, and then add an IP of 192.168.1.XXX or 192.168.11.XXX on the PC.

- 1 On the PC, click 'Network (or Ethernet)→Properties'.
- 2 Double-click 'Internet Protocol Version 4 (TCP/IPv4)'.

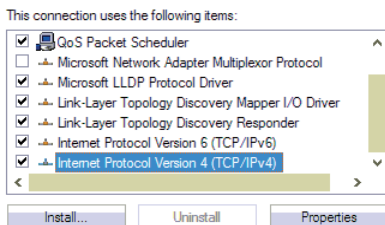
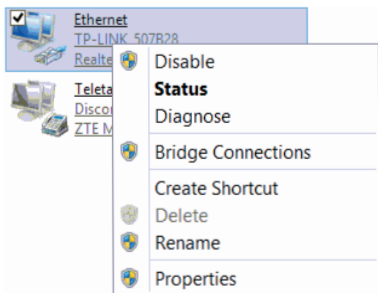

- 3 Select 'Use the following IP address', and then enter an available IP address '192.168.11.XXX' or '192.168.1.XXX'.

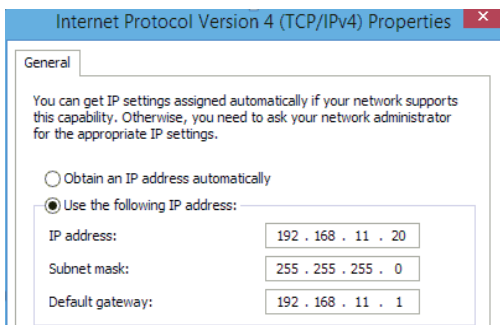

## 8 Log in Web Management System

Open a web browser and enter the IP address of the trunk gateway, and then input the IP address of GE0 or GE1 which is connected to the PC. Press **Enter**, and the login GUI will be displayed.

Model	GE0 IP	GE1 IP
MTG200	192.168.11.1 (for management)	192.168.1.111 (for services)
MTG1000B	192.168.11.1 (for management)	192.168.1.111 (for services)
MTG2000B	192.168.11.1 (for management)	192.168.1.111 (for services)
MTG2000	192.168.11.1 (for management)	192.168.1.111 (for services)

Enter username and password in the displayed login GUI. Both the default username and password are admin.

Note: PC and the connected network port must be at the same network segment.

## 9 Modify IP Address of Network Port for Services

After logging in the trunk gateway, user needs to modify the IP address of the network port for services. If there's a public static IP address, please configure the IP address of the network port into this static IP address. If SIP server is connected to a private network, the network port for services should be at the same network segment with the SIP server. After that, please restart the gateway for the configurations to take effect.

The network port for management is only used for local management, while the network port for services is used for voice and signaling interacting.

## 10 Configure PRI/SS7 Trunk

### (1) Configure PRI Trunk

On the [PRI Config](#) → [PRITrunk](#) interface, add a PRI trunk. 'Channel ID' of the PRI trunk should be the same with that of the peer switch.

As for the 'Switch Side' parameter, if the peer switch is configured as 'User Side', the PRI trunk should be configured as 'Network Side'; If the peer switch is configured as 'Network Side', the PRI trunk should be configured as 'User Side'.

### PRI Trunk Modify

Trunk No.	<input type="text" value="1"/>
Trunk Name	<input type="text" value="REPBX"/>
Channel ID	<input type="text" value="0"/>
D-Channel	<input type="text" value="Enable"/>
E1/T1 Port No.	<input type="text" value="0"/>
Protocol	<input type="text" value="ISDN"/>
Switch Side	<input type="text" value="User Side"/>
Alerting Indication	<input type="text" value="ALERTING"/>

## (2) Configure SS7 Trunk

- ① On the SS7 Config → SS7 trunk interface, add an SS7 trunk.

Please consult local service provider about the information of Protocol Type (TUP/ISUP), OPC and DPC.

SS7 Trunk Add	
Select Trunk No.	0
Trunk Name	TELE
Protocol	ITU--CHINA
Protocol Type	ISUP
SPC Format	Hex
OPC	a03d
DPC	2eed
Support APC	Disable
Network Indicator	National Network
Sending SLTM	Enable
Early Alerting	Disable
Link Set No.	None

- ② On the SS7 Config → SS7 MTP Link interface, add an SS7 signaling link for the trunk. Please Consult local service provider about 'E1/T1 Port No.', 'Channel No.' of the SS7 signaling link, as well as 'Caller Type'.

SS7 MTP Link Add	
No.	0
Trunk No.	0 <TELE>
Link No.	0
Signaling Link Code	0
E1/T1 Port No.	0
Channel No.	16
Caller Type	Subscriber
Callee Type	Not Configured
OrgCallee Type	Not Configured
Numbering Plan	ISDN
Calling Presentation	Allowed
Screening indicator	User Provided
Called Stop sending	Disable
Calling Stop sending	Disable
Link Mode	Default

- ③ On the SS7 Config→SS7 CIC interface, add an SS7 circuit for the SS7 trunk. Generally, an E1 port contains 32 channels, while a T1 port has 24 channels. Please consult local service provider about the 'Start CIC No.'.

SS7 Circuit Add	
Trunk No.	0 <TELE>
Start E1/T1 port No.	0
End E1/T1 port No.	0
Start Channel	0
Start CIC No.	0
Count	32

## 11 Configure E1/T1 Frame Mode

On the [PSTN Group Config](#) → [E1/T1 Parameter](#) interface, modify the frame mode of E1/T1 port to make it the same with that of the peer device.

E1/T1 Parameter						
	Port No.	Work Mode	PCM Mode	Frame Format	Line Code	Port Status
<input type="checkbox"/>	0	E1	A LAW	MF-CRC4	HDB3	Open
<input type="checkbox"/>	1	E1	A LAW	MF-CRC4	HDB3	Open
<input type="checkbox"/>	2	E1	A LAW	MF-CRC4	HDB3	Open
<input type="checkbox"/>	3	E1	A LAW	MF-CRC4	HDB3	Open

## 12 Configure SIP Trunk

- (1) On the [SIP Config](#) → [SIP Trunk](#) interface, user needs to fill in the IP address of the peer device (remote address) and remote port. Other parameters can be retained as default settings.

SIP Trunk Add	
Trunk No.	1
Trunk Name	SIP PBX
Remote Address	10.10.0.50
Protocol Type	UDP
Remote Port(UDP)	5060
Outbound Proxy	
Outbound Proxy Protocol Type	UDP
Outbound Proxy Port(UDP)	5060
Local Domain	Disable
Support SIP-T	Disable
Get Callee from	Request-line
Get Caller from	User Name
Register to Remote	No
Incoming SIP Authentication Type	IP Address
Rport	Disable
Dynamic Nat	Disable
Outgoing Calls Restriction	No
Incoming Calls Restriction	No
Incoming Time Restriction	Disable
Detect Trunk Status	No
Heartbeat Username	heartbeat
Enable SIP Trunk	Yes

# 13 Configure Outbound & Inbound Routes

## (1) Configure Outbound Route

On the [Call Routing](#) → [IP>PSTN Routing](#) interface, add an outbound route. Select a source trunk and a destination trunk that have been created. If '.' is filled in for Caller Prefix and Callee Prefix, it means any number can be the caller number and callee number of this outbound route.

IP->PSTN Routing Add	
Index	255
Description	call out
Source Type	Trunk
Trunk Type	SIP
IP Trunk No.	1 <SIP PBX>
Callee Prefix	.
Caller Prefix	.
Destination Type	Trunk
PSTN Trunk	1 <REPBX>
Filter Profile ID	255 <None>

## (2) Configure Inbound Route

On the [Call Routing](#) → [PSTN>IP Routing](#) interface, add an inbound route. Select a source trunk and a destination trunk that have been created. If '.' is filled in for Caller Prefix and Callee Prefix, it means any number can be the caller number and callee number of this inbound route.

Route PSTN->IP Add	
Index	255
Description	call in
Source Type	Trunk
PSTN Trunk	1 <REPBX>
Callee Prefix	.
Caller Prefix	.
Destination Type	Trunk
Trunk Type	SIP
IP Trunk No.	1 <SIP PBX>
Number Filter Profile ID	255 <None>

# 14 More Details

This document only provides instructions for quick installation and basic configuration, For detailed configuration and parameter explanation, please refer to user manual or ask for online technical support.

# 15 Trouble Shooting

- (1) What if E1/T1 indicator is still dull after the corresponding E1/T1 port has been connected to an E1/T1 cable?
  - A. In case that the E1/T1 port is directly connected to a peer device with a standard RJ48C E1/T1 cable, please check whether the peer device is equipped with standard RJ48C interface first, and then check whether the wire sequence of E1/T1 cable is correct or not.
  - B. In case that the E1/T1 port is connected to a switch with E1/T1 cable and coaxial line, please check whether the connector of BNC transit box works well or not, and then check whether the RX end and TX end are connected properly.
  - C. Exchange the E1/T1 cable with another one that works normally, so as to confirm whether the E1/T1 port malfunctions.
  
- (2) What if E1/T1 indicator flashes after the corresponding E1/T1 port has been connected to an E1/T1 cable?

Log into the web management system to modify the frame mode of the E1/T1 port. If the E1/T1 indicator still flashes, it means there are error codes in the physical link. Please contact service provider to check this problem.
  
- (3) Forget the IP address of the trunk gateway.

Connect the trunk gateway's console port to a PC via an RS232 serial cable. After the command interface is displayed, input 'show int' under the 'ROS#' mode to query the current IP address of the gateway.
  
- (4) Forget username and password.

Connect the trunk gateway's console port to a PC via an RS232 serial cable, and then ask for online technical support.

Honest, Concentrated, Innovative, Open

Shenzhen Dinstar Co., Ltd.

Website: <http://www.dinstar.com>

Facebook: <http://www.facebook.com/dinstarvoip/>

