



## **DAG2000-24/32S FXS VoIP Gateway**

### **User Manual V1.0**



#### **Dinstar Technologies Co., Ltd.**

Address: 9<sup>th</sup> Floor, Guoxing Building, Changxing Road, Nanshan District, Shenzhen, China

Postal Code: 518052

Telephone: +86 755 61919966

Fax: +86 755 2645 6659

Emails: [sales@dinstar.com](mailto:sales@dinstar.com), [support@dinstar.com](mailto:support@dinstar.com)

Website: [www.dinstar.com](http://www.dinstar.com)

---

# Preface

---

## Welcome

Thanks for choosing the **DAG2000-24/32S Analog Gateway for VoIP!** We hope you will make full use of this rich-feature FXS VoIP Gateway. Contact us if you need any technical support: +86-755-61919966.

## About This Manual

This manual provides information about the introduction of the analog telephone adapter, and about how to install, configure or use it. Please read this document carefully before install the gateway.

## Intended Audience

This manual is aimed primarily at the following people:

- Users
- Engineers who install, configure and maintain the gateway.

## Revision Record

Document Name	Document Version	Firmware Version
DAG2000-24/32S FXS VoIP Gateway User Manual V1.0	V1.0 (2020/29/12)	2.81.10.09

---

# Contents

---

<b>1 Product Introduction</b>	<b>1</b>
1.1 Overview	1
1.2 Application Scenario	1
1.3 Product Appearance	2
1.3.1 Appearance of DAG2000-24S	2
1.3.2 Appearance of DAG2000-32S	2
1.3.3 Ports and Connector	2
1.4 Features & Functions	4
1.4.1 Key Features	4
1.4.2 Physical Interfaces	4
1.4.3 Voice Capabilities & Fax	4
1.4.4 FXS	5
1.4.5 VoIP	5
1.4.6 Software Features	6
1.4.7 Supplementary Services	6
1.4.8 Environmental	6
1.4.9 Maintenance	6
<b>2 Quick Installation</b>	<b>8</b>
2.1 Installation Attentions	8
2.2 Installation Steps	8
2.3 Network Connection	9
2.3.1 Network Connection Diagram under Bridge Mode	9
2.4 Preparations for Login	9
2.4.1 Log In Web Interface	9
<b>3 Basic Operation</b>	<b>11</b>
3.1 Methods to Number Dialing	11
3.2 Call Holding	11
3.3 Call Waiting	11
3.4 Call Transfer	11
3.4.1 Blind Transfer	11
3.4.2 Attended Transfer	12
3.5 Function of Flash-hook	12

---

3.6 Description of Feature Code	13
3.7 Send or Receive Fax	14
3.7.1 Fax Mode Supported	14
3.7.2 Explanation of T.38 and Pass-through	14
3.8 Function of RST Button	15
3.9 Query IP Address and Restore Default Setting	15
<b>4 Configurations on Web Interface</b>	<b>16</b>
4.1 Navigation Tree	16
4.2 Status & Statistics	16
4.2.1 System Information	17
4.2.2 Registration	19
4.2.3 TCP/UDP Statistics	19
4.2.4 RTP Session	20
4.2.5 CDR	20
4.2.6 Record Statistics	21
4.3 Quick Setup Wizard	21
4.4 Network	21
4.4.1 Local Network	21
4.4.2 VLAN (Virtual Local Area Network)	22
4.4.3 DHCP Option	23
4.4.4 QoS	24
4.4.5 ARP	25
4.5 SIP Server	25
4.6 IP Profile	28
4.7 Tel Profile	28
4.8 Port	28
4.9 Advanced	30
4.9.1 Line Parameter	30
4.9.2 FXS Parameter	32
4.9.3 Media Parameter	34
4.9.4 Service Parameter	35
4.9.5 SIP Parameter	39
4.9.6 NAT Parameter	44
4.9.7 Speed dial	44
4.9.8 Feature Code	46
4.9.9 System Parameter	48
4.10 Call & Routing	50

---

4.10.1 Port Group	50
4.10.2 IP Trunk	52
4.10.3 Routing Parameter	53
4.10.4 IP → Tel Routing	54
4.10.5 Tel → IP/Tel Routing	55
4.10.6 IP → IP Routing	56
4.11 Manipulation	56
4.11.1 IP → Tel Callee	57
4.11.2 Tel → IP/Tel Caller	58
4.11.3 Tel → IP/Tel Callee	59
4.12 Management	61
4.12.1 TR069	61
4.12.2 SNMP	62
4.12.3 Syslog	65
4.12.4 Provision	65
4.12.5 Cloud server	66
4.12.6 User Manage	67
4.12.7 Remote Server	67
4.12.8 Action URL	68
4.13 Security	68
4.13.1 WEB ACL	68
4.13.2 Telnet ACL	69
4.13.3 Passwords	69
4.13.4 Encrypt	70
4.14 Tools	70
4.14.1 Firmware Upload	70
4.14.2 Data Backup	71
4.14.3 Data Restore	72
4.14.4 Ping Test	72
4.14.5 Tracert Test	73
4.14.6 Outward Test	73
4.14.7 Network Capture	74
4.14.8 Factory Reset	76
4.14.9 Device Restart	76
<b>5 Glossary</b>	<b>77</b>

# 1 Product Introduction

## 1.1 Overview

DAG2000-24/32S VoIP gateway provides voice services based on IP network. It's a cost-effective and flexible solution for SOHO (Small Office-Home office), remote office, medium-sized enterprise and enterprise with multiple branches.

The gateway connects to analog telephone, fax and traditional analog PBX with standard voice interfaces and provides high quality voice service.

The gateway, based on standard SIP protocol is compatible with leading IP PBX, soft-switch and SIP-based platform.

The FXS analog gateway available in the following configurations:

- ✓ DAG2000-24S, 24 port FXS VoIP gateway
- ✓ DAG2000-32S, 32 port FXS VoIP gateway

## 1.2 Application Scenario

The application scenario of DAG2000-24/32S is shown as follows:

Figure 1-1 Application Scenario of DAG2000-24/32S

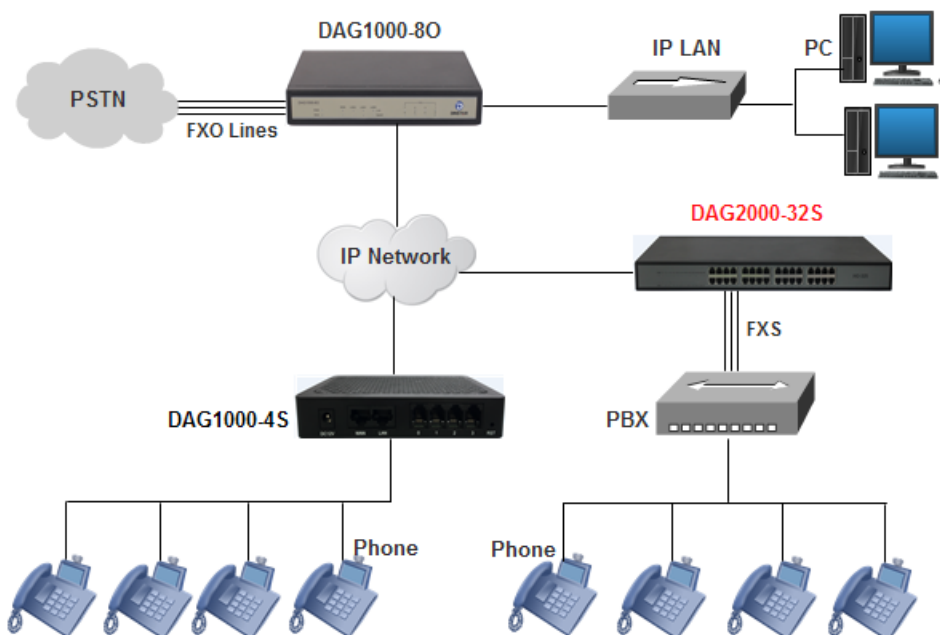

## 1.3 Product Appearance

### 1.3.1 Appearance of DAG2000-24S

Front View:



Back View:



### 1.3.2 Appearance of DAG2000-32S

Front View:



Back View:



### 1.3.3 Ports and Connector

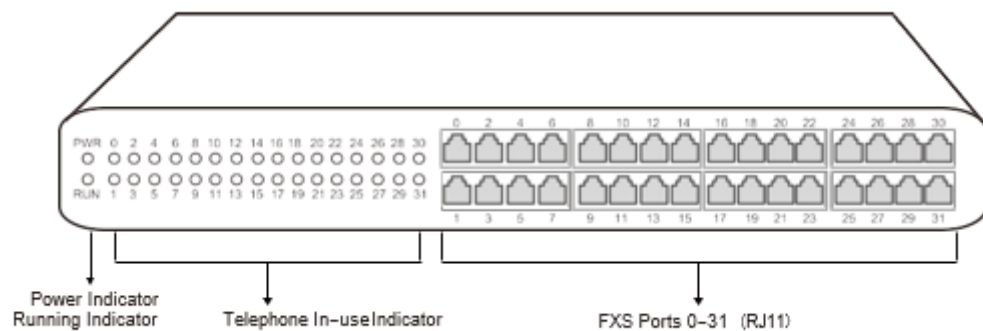

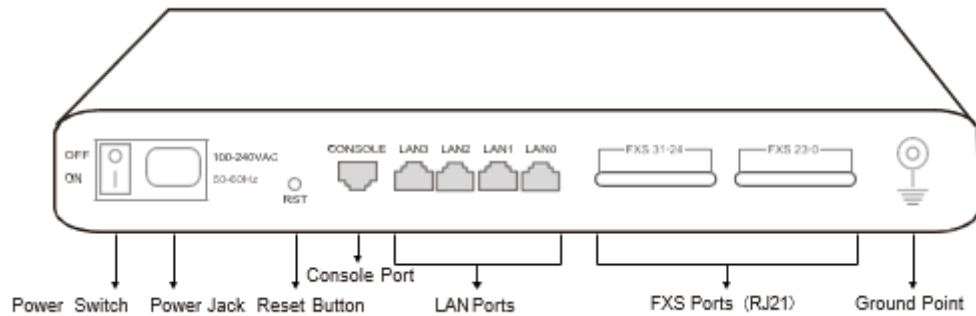

The description of interfaces of DAG2000-24/32S

Port Name	Connector	Description
Power Jack	Power Jack	To connect 100-240V AC 50-60HZ power supply
LAN Port	RJ45	to connect to the IP network over a DSL modem or Router or a LAN switch
FXS Ports 0-31	RJ11	FXS ports to connect standard analog phone or FAX machine or a PBX
Console Port	RJ48	Console port is used to carry out maintenance-related configurations

The description of indicators of DAG2000-24/32S

Indicator	Definition	Status	Description
PWR	Power Indicator	On	The gateway is powered on
		Off	The gateway has no power input or power supply is abnormal
RUN	Running Indicator	Slow Flashing	The gateway is running properly
		Fast Flashing	SIP account is registered successfully
		Off	The gateway is running improperly



FXS	Telephone In-use Indicator	On	FXS port is currently occupied by a call
		Off	FXS port is idle or faulty
WAN/ LAN	Link (Green)	Flashing	The gateway is properly connected to network
		Off	The gateway is not connected to network or network connection is improper

## 1.4 Features & Functions

### 1.4.1 Key Features

- Cost effective gateway with 24/32 FXS ports
- Fax over IP (T.38 and Pass-Through)
- Support IPv4 and IPv6
- TR069 and SNMP
- Multiple codecs: G.711A/U,G.723.1,G.729A/B,AMR,G.726 etc.
- Fully compatible with leading IMS/NGN, SIP based IP telephony system

### 1.4.2 Physical Interfaces

- Telephone Port  
DAG2000-24S: 24 FXS port (RJ11 and RJ21)  
DAG2000-32S: 32 FXS ports (RJ11 and RJ21)
- Ethernet Interfaces  
DAG2000-24/32S:  
4\* LAN, 10/100Mbps, RJ-45
- Console:  
1\*RS232, 115200bps

### 1.4.3 Voice Capabilities & Fax

- Codecs: G.711a/μ law, G.723.1, G.729A/B, G.726
- Silence Suppression
- Comfort Noise Generator(CNG)
- Voice Activity Detection(VAD)

- Echo Cancellation: G.168 with up to 128ms
- Adaptive (Dynamic) Jitter Buffer
- Hook Flash
- Adjustable Gain Control
- Programmable Gain Control
- FAX: T.38 and Pass-through
- High speed fax up to 14.4kbps
- Modem/POS
- DTMF: SIP Info/RFC2833/Inband
- VLAN 802.1P/802.1Q (Voice/Data/Management VLANs)
- Layer 3 QoS and DiffServ

#### 1.4.4 FXS

- FXS Connector: RJ11
- Dial Mode: DTMF and Pulse
- Pulse: 10 and 20 PPS
- Caller ID: DTMF/FSK CLI Presentation
- Max Cable Length: 5km
- Reversed Polarity
- Programmable Call Progress Tone

#### 1.4.5 VoIP

- Protocols: SIP v2.0 (UDP/TCP), RFC3261, SDP, RTP(RFC2833), RFC3262, RFC3263, RFC3264, RFC3265, RFC3515, RFC2976, RFC3311
- RTP/RTCP, RFC2198, RFC1889
- SIP over TLS
- RFC4028 Session Timer
- RFC3266 IPv6 in SDP URI
- RFC 3581 NAT.rport
- Primary/Backup SIP Server
- Outbound Proxy
- DNS SRV/A Query/NATPR Query
- SIP Trunk
- Early Media/Early Answer\
- NAT: STUN, Static/Dynamic NAT

## 1.4.6 Software Features

- Hunting Group
- Web ACL
- Telnet ACL
- Action URL
- PPPoE/IPv4/IPv6
- Digitmap
- Bandwidth Optimization
- Routing Rules based on Prefixes
- Caller/Called Number Manipulation

## 1.4.7 Supplementary Services

- Call Waiting and Call Holding
- Call Forwarding (Unconditional/Busy/No Reply)
- Call Transfer (Blind & Attended)
- Warm/Immediately Hotline
- Do-not-disturb
- Three Parties Conversation (3-way Conference)
- Message Waiting Indicator

## 1.4.8 Environmental

- Power Supply: 100-240VAC, 50-60 Hz
- Power Consumption:40W(Typical)
- Operating Temperature:0 °C ~ 45 °C
- Storage Temperature: -20 °C ~80 °C
- Humidity:10%-90% Non-Condensing
- Dimensions(W/D/H): 440\*250\*44mm
- Unit Weight: 3.2kg
- Compliance: CE, FCC

## 1.4.9 Maintenance

- SNMP V1/V2/V3
- TR069
- Auto Provisioning (HTTP/FTP/TFTP)
- Web/Telnet

- Configuration Backup/Restore
- Firmware Upgrade via Web
- CDR
- Syslog(Emerg,alert, critical,error warning,notice,info, debug)
- Ping, Tracert Test
- Network Capture
- Outward Test (GR909 Standard)
- NTP/Daylight Saving Time
- IVR Local Maintenance
- Cloud-based Management

# 2 Quick Installation

---

## 2.1 Installation Attentions

To avoid unexpected accident or device damage, please read the following instructions before installing the DAG2000 device:

- DAG2000-24/32S is equipped with both RJ11 and RJ21 ports;
- For the wire sequence of RJ21, please refer to Section 6 Wire Sequence of this manual.
- Anti-jamming: to reduce the interference with telephone calls, it's highly recommended that telephone lines connected to the gateway should be placed away from power cables;
- Power supply: the gateway accepts AC input voltage of 100-240V. Please ensure safe and stable power supply;
- Network bandwidth: please ensure there is enough network bandwidth so as to guarantee stabilized running of the gateway;
- Ventilation: to avoid overheating, please do not pile up the gateway with other devices and make sure the gateway has good ventilation around.
- Temperature and humidity: to avoid any accident that might cause malfunction, it's advised to install the gateway in an equipment room where temperature and humidity are appropriate;
- Mechanical load: please make sure the gateway is placed steadily to avoid damage. It's highly advised to horizontally place the gateway on a flat surface or a cabinet.

## 2.2 Installation Steps

- Connect the power adapter to the power jack of the DAG2000 device;
- Connect telephone line to the FXS port(s);
- Connect network cable to the LAN port;

## 2.3 Network Connection

DAG2000-24/32S works in network mode: bridge mode. When it works without VLAN , network cable can connect to any of LAN port while VLAN enabled, network cable must be connected to LAN3.

### 2.3.1 Network Connection Diagram under Bridge Mode

Under the Bridge mode, the IP address of WAN port is the same with that of LAN port. Generally, when the device works under the bridge mode, the IP address of the device has been modified. In the following diagram, it is assumed that the IP address has been modified into 172.19.211.103.

Figure Network Connection Diagram under Bridge Mode

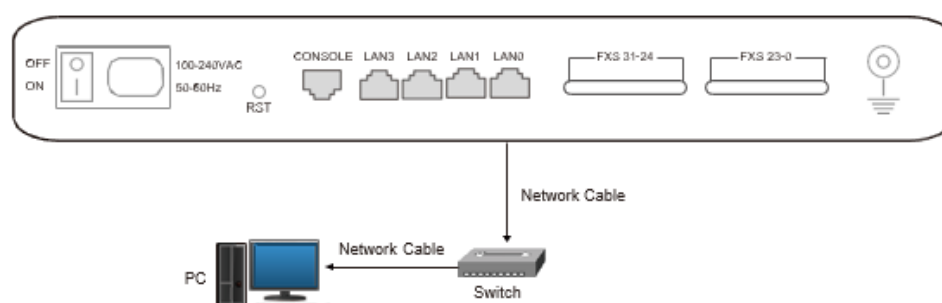

Note: The IP address of PC and that of WAN port of the DAG2000-24/32S device are at the same network segment.

## 2.4 Preparations for Login

Firstly, connect the device to network according to the above network diagrams, and connect a telephone to the FXS port. Then dial \*158# to query the IP address of the LAN port (default IP is 192.168.11.1).

Secondly, modify the IP address of the PC to make it at the same network segment with the LAN port of the device.

Thirdly, check the connectivity between the PC and the device. Click **Start** → **Run** of PC and enter **cmd** to execute 'ping 192.168.11.1' to check whether the IP address of LAN port runs normally.

### 2.4.1 Log In Web Interface

Open a web browser and enter the IP address of LAN port (the default IP is 192.168.11.1). Then the login GUI will be displayed.

You also can enter the IP address of WAN port, but it's required to modify the IP address of PC to make it at the same network segment with WAN port and 'Access Web by WAN' is enabled on the **Advanced** → **System Parameter** page.

It is suggested that you should modify the username and password for security consideration.

Figure 2-1 Login GUI

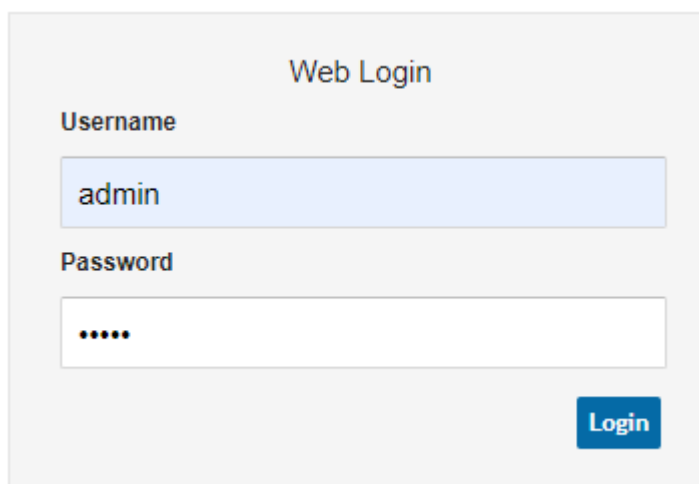
The image shows a web login interface titled "Web Login". It features two input fields: "Username" with the text "admin" and "Password" with five dots. A blue "Login" button is located at the bottom right of the form.

Web Login

Username

admin

Password

.....

Login

Both the default username and password are admin. Click **Login** to enter into the web interface.

# 3 Basic Operation

---

## 3.1 Methods to Number Dialing

There are two methods to dial telephone number or extension number:

- Dial the called number and wait for 4 seconds for dialing timeout, or dial the called number directly (the system will judge whether the dialing is completed according to Digitmap and Regular Expression dialplans).
- Dial the called number and press #.

## 3.2 Call Holding

If a calling party places a call to a called party which is otherwise engaged, and the called party has the call holding feature enabled, the called party is able to switch to the new incoming call while keeping the current call holding on by dialing \*# or pressing the flash button/flash hook.

When the called party dials \*# once again or presses the flash button/ flash hook once again, he or she will switch back to the first call.

## 3.3 Call Waiting

If a calling party places a call to a called party which is otherwise engaged, and the called party has the call waiting feature enabled, the calling party will hear a IVR voice 'Please hold on, the subscriber you dialed is busy' and the called party will hear three beeps if waiting tone is enabled.

By pressing the flash button or the flash hook, the called party is able to switch between the new incoming call and the current call.

## 3.4 Call Transfer

### 3.4.1 Blind Transfer

Blind transfer is a call transfer in which the transferring party connects the call to a third party without notifying the third party.



Example: A gives a call to B and B wants to blindly transfer the call to C. Operation instructions are as follows:

1. A dials the extension number of B;
2. The extension of B rings, and B picks up the phone. Then A and B go into conversation;
3. B presses the flash button (or flash hook), and dial \*87\* after hearing a dialing tone to trigger blind transfer. Then B dials the extension number of C (end up with #).
4. The extension of C rings, B hangs up the phone and C picks up the phone. Then C and A goes into conversation.

Note:

- On the 'Advanced → Feature Code' page, blind transfer should be enabled.
- If B hears continuous busy tones after he dials the extension number of C, it means the call has timed out.

### 3.4.2 Attended Transfer

Attended transfer is a call transfer in which the transferring party connects the call to a third party after he confirms that the third party agrees to answer the call.

Example: A gives a call to B and B wants to attended transfer the call to C. Operation instructions are as follows:

1. A dials the extension number of B;
2. The extension of B rings, and B picks up the phone. Then A and B go into conversation;
3. B presses the flash button (or flash hook), and then dials the extension number of C (end up with #).

;

Then one of the following situations will happen:

- a. If C answers the call and accepts the transfer, B will hand up the phone, and then C and A go into conversation.
- b. If the extension of C cannot be reached or if C rejects the call, B needs to press the flash button to resume the call with A.

## 3.5 Function of Flash-hook

Assume A and B are in a call conversation:

If B presses the flash hook, and then dial the number of C, B and C go into conversation and meanwhile the call between B and A is kept holding.

Then, if B presses the flash hook and dials 1, the conversation will switch back to A and B; if B presses the flash hook and dials 2, the conversation will switch to B and C; if A presses the flash hook and dials 3, the conversation will switch to A, B and C (which is named

‘three-way calling’).

## 3.6 Description of Feature Code

DAG2000-24/32S provides convenient telephone functions. Connect a telephone to the FXS port and dial a specific feature code, and you can query corresponding information.

Code	Corresponding Function
<b>*159#</b>	Dial *159# to query WAN IP
<b>*158#</b>	Dial *158# to query LAN IP
<b>*114#</b>	Dial *114# to query the phone number of a FXS port
<b>*115#</b>	Dial *115# to query the phone number of a FXS port group
<b>*168#</b>	Dial *168# to query the register status of a FXS port
<b>*157*</b>	Dial *157*0 to set route mode; dial *157*1 to set bride mode
<b>*150*</b>	Dial *150*1 to set IP address as static IP address; dial *150*2 to set IP address as DHCP IP address
<b>*152*</b>	Dial *152* to set IPv4 address, for example: Dial *152*192*168*1*10# to set IPv4 address as 192.168.1.10
<b>*156*</b>	Dial *156* to set IPv4 gateway, for example: Dial *156*192*168*1*1# to set IPv4 gateway as 192.168.1.1
<b>*153*</b>	Dial *153* to set IPv4 netmask, for example: Dial *153*255*255*0*0*# to set IPv4 netmask as 255.255.0.0
<b>*170#</b>	Dial *170# to increase the sound volume of a FXS port
<b>*171#</b>	Dial *171# to decrease the sound volume of a FXS port
<b>*160*</b>	Dial *160*1# to allow HTTP WAN access, Dial *160*0# to deny HTTP WAN access
<b>*165*</b>	Dial *165*000000# to restore username/password and network configuration to factory defaults
<b>*111#</b>	Dial *111# to restart the device
<b>*47*</b>	Dial *47* to allow call through IP address, for example: Dial *47*192*168*1*1# to allow to call through the IP address of 192.168.1.1
<b>*51#</b>	Dial *51# to enable the call waiting service
<b>*50#</b>	Dial *50# to disable the call waiting service
<b>*87*</b>	Dial *87* to trigger blind transfer, for example:

	Dial *87*8000#, and you can blind transfer to the extension number 8000
*72*	Enable unconditional call forwarding service. Example: Dial *72*8000, and calls will be unconditionally forwarded to extension number 8000
*73#	Disable unconditional call forwarding service
*90*	Enable the 'call forwarding on busy' service. Example: Dial *90*8000, and calls will be forwarded to extension number 8000 when the called number is busy
*91#	Disable the 'call forwarding on busy' service
*92*	Enable the 'call forwarding on no reply' service. Example: Dial *92*8000, and calls will be forwarded to extension number 8000 when there is no reply from the called number
*93#	Disable the 'call forwarding on no reply' service
*78#	Enable the 'No Disturbing' service
*79#	Disable the 'No Disturbing' service
*200#	Dial *200# to access voicemail

**Note:**

A voice prompt indicating successful configuration will be played after each configuration procedure. Please do not hang up the phone until hearing this voice prompt.

## 3.7 Send or Receive Fax

### 3.7.1 Fax Mode Supported

- T.38 (IP-based)
- T.30 (Pass-Through)
- Adaptive Fax Mode (automatically match with the peer fax mode)

### 3.7.2 Explanation of T.38 and Pass-through

**T.38** is an ITU recommendation for allowing transmission of fax over IP networks in real time. Under the T.38 mode, analog fax signal is converted into digital signal and fax signal tone is restored according to the signal of peer device. Under the T.38 mode, fax traffic is carried in T.38 packages.

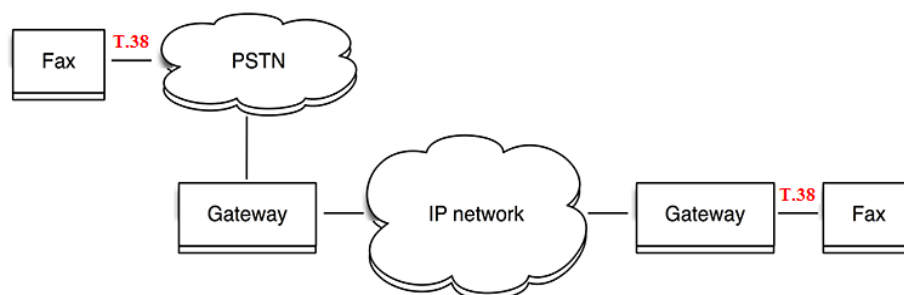

**T 3.0 (Pass-through):** Under the pass-through mode, fax signal is not converted and fax traffic is carried in RTP packets. It uses the G.711 A or G711U codec in order to reduce the damage to fax signal.

**Adaptive Fax Mode:** automatically match with the fax mode of the peer device.

## 3.8 Function of RST Button

Press the RST button of DAG2000-24/32S for a moment, the running indicator will turn from “slow flashing” into “no flashing”, and then turn into “slow flashing” again. That means the device has been restored to factory defaults.

## 3.9 Query IP Address and Restore Default Setting

### Query IP Address:

After connecting a telephone to the FXS port, you can dial \*158# to query the IP address of LAN port and dial \*159# to query the IP address of WAN port.

### Reset Password:

1. On the “Security → Passwords” page of the Web interface, you can reset username and password.
2. You can also reset password through the Cloud platform.
3. Connect a telephone with the DAG2000 device, and then dial \*165\*000000# to restore username/password and network configuration to factory defaults.

### Restore Device to Default Settings:

1. Connect a telephone with the DAG2000 device, and then dial \*166\*000000# to restore all configurations to factory defaults.
2. Press the RST button for a moment, the running indicator will turn from “slow flashing” into “no flashing”, and then become “slow flashing” again. That means all configurations of the device has been restored to factory defaults.
3. On the “Tools → Factory Reset” page of Web interface, click **Apply** to restore the configurations of the device to factory defaults.

# 4 Configurations on Web Interface

## 4.1 Navigation Tree

The web management system of the DAG2000-24/32S VoIP device consists of the navigation tree and detailed configuration interfaces.

Choose a node of the navigation tree to enter into a detailed configuration interface.

Figure 4-1 Navigation Tree of Web Interface

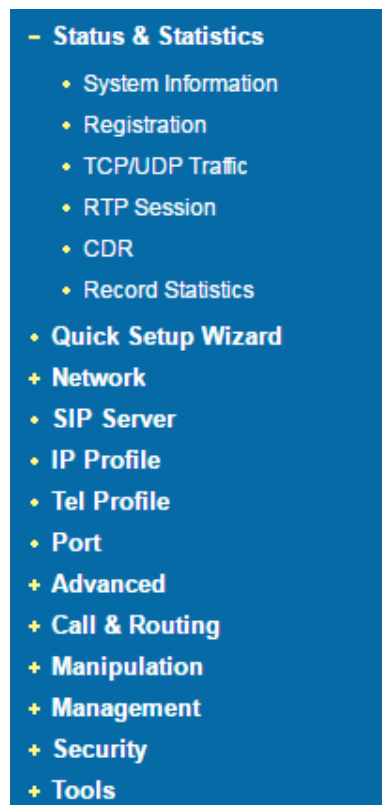

## 4.2 Status & Statistics

The 'Status & Statistics' menu mainly displays all kinds of information. It includes the following sub-menus: System Information, Registration, TCP/UDP Traffic, RTP Session, CDR and Record Statistics.

## 4.2.1 System Information

On the System Information interface, you can view the information of device ID, MAC address, network mode, IP addresses, version information, sever register status and so on.

Log in the Web interface, and then click **Status & Statistics** → **System Information**, and the following page will be displayed. On the page, you can view the information of device ID, MAC address, network mode, IP addresses, version information, server register status and so on.

Figure 4-2 System Information

System Information			
Device ID	da27-1009-2730-0041		
MAC Address	F8-A0-3D-30-45-0C		
IP Address	172.19.211.103	255.255.0.0	Static
	172.19.1.1		
DNS Server	8.8.8.8	4.4.4.4	
Cloud Register Status	Not Registered		
System Uptime	0 h: 42 m: 55 s		
NTP Status	Succeed		
NTP Time	2020-11-16 01:49:49		
Traffic Statistics	Received 1666729 bytes	Sent 106392 bytes	
Usage of Flash	55 %(6164480 / 11010048) bytes		
Usage of RAM in Linux	25 %(56360960 / 222314496) bytes		
Usage of RAM in AOS	9 %(6266880 / 67100672) bytes		
Current Software Version	DAG2000-32S 2.81.10.09 PCB 6 LOGIC 0 BIOS 1, 2020-10-15 2:57:02		
DSP Version	ARM_32_8 Nov 17 2017 16:43:27		
U-BOOT Version	3		
Kernel Version	5		
FS Version	6		
Hint Language	English		

Table 4-1 Explanation of Items on System Information Interface:

<b>Device ID</b>	A unique ID of each device. This ID is used for warranty and cloud server authentication.
<b>MAC address</b>	Hardware address of the WAN port
<b>IP Address</b>	There are three kinds of IP address for the WAN port and LAN port: <b>DHCP: Obtain IP address automatically.</b> DAG2000 is regarded as a DHCP client, which sends a broadcast request and looks for a DHCP server from the LAN to answer. Then the first discovered DHCP server automatically assigns an IP address to the DAG2000 from a defined

	<p>range of numbers.</p> <p><b>Static IP Address:</b> Static IP address is a semi-permanent IP address and remains associated with a single computer over an extended period of time. This differs from a <b>dynamic IP address</b>, which is assigned <i>ad hoc</i> at the start of each session, normally changing from one session to the next.</p> <p>If you choose static IP address, you need to fill in the following information:</p> <ul style="list-style-type: none"> <li>● IP Address: the IP address of the WAN port of the DAG2000;</li> <li>● Subnet Mask: the netmask of the router connected the DAG2000;</li> <li>● Default Gateway: the IP address of the router connected the DAG2000;</li> </ul> <p><b>PPPoE:</b> PPPoE is an acronym for point-to-point protocol over Ethernet, which relies on two widely accepted standards: PPP and Ethernet. PPPoE is a specification for connecting the users on an Ethernet to the Internet through a common broadband medium, such as a single DSL line, wireless device or cable modem. PPPOE IP address refers to IP address assigned through the PPPoE mode.</p> <p>If you choose PPPoE, you need to fill in to fill in the following information:</p> <ul style="list-style-type: none"> <li>● Username: the account name of PPPoE</li> <li>● Password: the password of PPPoE</li> <li>● Server Name: the name of the server where PPPoE is placed</li> </ul>
<b>DNS Server</b>	IP addresses of primary DNS server and standby DNS server are displayed.
<b>Cloud Register Status</b>	Whether the DAG2000 device is registered to cloud or not.
<b>System Uptime</b>	The running time of the DAG2000 device since it is powered on.
<b>NTP Status</b>	Succeed: the DAG2000 device is sync to NTP server successfully; Failed: the DAG2000 device fails to be sync to NTP server. Then you should check network connection and the NTP server.
<b>WAN Traffic Statistics</b>	Total bytes of message received and sent by WAN port.
<b>Usage of Flash</b>	Detailed usage of Flash memory
<b>Usage of RAM in Linux</b>	detailed RAM usage of Linux core
<b>Usage of RAM in AOS</b>	Detailed RAM usage of AOS

<b>Current Software Version</b>	The software version that runs on the DAG2000 device. Model name, version number and the software development date are displayed.
<b>Backup Software Version</b>	Backup software is for the purpose of backup. When the current software fails, the backup software version will work.
<b>U-boot Version</b>	U-boot version
<b>Kennel version</b>	Linux Kennel version
<b>FS Version</b>	File system version
<b>Hint Language</b>	The current language of the DAG device

## 4.2.2 Registration

On the **Status & Statistics** → **Registration** page, you can view the registration status of each FXS port or port group.

Figure 4-3 Registration Status of Each FXS Port or Port Group

Port Registration Information			
Port No.	Type	SIP User ID	SIP User Status
0	FXS	056000...	Registered
1	FXS	056001...	Registered

Port Group Registration Information			
Port Group	Port	SIP User ID	SIP User Status
1 <10001>	0,1,...	10001...	Registered

SIP User status:

- ▶ Registered: the port or port group is registered to SIP server successfully;
- ▶ Unregistered: the port or port group fails to be registered to SIP server.

## 4.2.3 TCP/UDP Statistics

On the **Status & Statistics** → **TCP/UDP Statistics** page, you can view the statistical number of sending or receiving packets over TCP, and the number of sending or receiving packets over UDP since the DAG2000 device is booted up.



Figure 4-4 TCP/UDP Statistics

TCP/UDP Traffic			
TCP Sent Packets	TCP Recv Packets	UDP Sent Packets	UDP Recv Packets
4139	2963	83598	64298

## 4.2.4 RTP Session

On the **Status & Statistics** → **RTP Session** page, you can view the real-time RTP session information, including: port, payload type, packet period, local port, peer IP, peer port, sent packets, received packets, lost packets, jitter and duration.

Figure 4-5 Real-time RTP Session Information

RTP Session										
Port	Payload Type	Packet Period	Local Port	Peer IP	Peer Port	Sent Packets	Recv Packets	Lost Packets	Jitter	Duration(s)
2	T.38	20	8008	172.16.95.50	8000	487	273	0	0	27

## 4.2.5 CDR

**CDR (Call Detail Record):** is a data record produced by a telephone exchange or a telecommunication device, which contains the details of a telephone call that passes through the device.

On the **Status & Statistic** → **CDR** page, you can enable the CDR function and view the details of all calls through the FXS ports of the DAG2000 device. You can also export, filter or clear the CDRs. 5000 pieces of CDRs can be saved at most.

Figure 4-6 CDRs of FXS Ports

CDR Report																			
Enable CDR		<input type="radio"/> No <input checked="" type="radio"/> Yes		<input type="button" value="save"/>		Port: <input type="text" value="All"/>		Source: <input type="text"/>		Destination: <input type="text"/>		CDR Oper: <input type="button" value="Export"/>		<input type="button" value="Filter"/>		<input type="button" value="Clear"/>			
Total: 65Item 50Item/Page 1/2Page <input type="text" value="Page1"/>																			
Port	Start Time	Answer Time	Direction	Source	Destination	PeerIP	PeerPort	LocalIP	LocalPort	Codec	FAX	Reason	EndCode	Session State	Duration (s)	RTPSend	RTP Recv	RTP Loss(%)	Jitter(ms)
1	2017/01/03 20:46:21	2017/01/03 20:46:24	CallOut	056001	051000	172.16.95.98	24392	172.16.95.35	8004	PCMU	--	Recv BYE	200	Normal	3	0	0	0	0
1	2017/01/03 19:44:12	0/00/00 00:00:00	CallOut	056001	051000	0.0.0.0	Unknow	172.16.95.35	8004	PCMA	--	Rejected	487	AbNormal	0	0	0	0	0
1	2017/01/03 19:38:39	2017/01/03 19:38:40	CallOut	056001	051000	172.16.95.98	21704	172.16.95.35	8004	PCMU	--	Recv BYE	200	Normal	2	0	0	0	0
1	2017/01/03 19:38:18	2017/01/03 19:38:19	CallOut	056001	051000	172.16.95.98	21704	172.16.95.35	8004	PCMU	--	Recv BYE	200	Normal	2	0	0	0	0

## 4.2.6 Record Statistics

On the **Status & Statistic** → **Record Statistics** page, record statistics including server status, count of current records, count of no response, count of server return errors, count of record starts, count of record startAck, count of record stops and count of stopAck are displayed.

Figure 4-7 Record Statistics

Record Statistics							
Server Stat	Current Records	No Responses	Server Return Error	Start	StartAck	Stop	StopAck
Not Config	0	0	0	0	0	0	0

No Response Statistics	
Link Dect NoRsp Cnt	0
Start Time Out Cnt	0
Rel Call Before StartAck	0
Stop Time Out Cnt	0

## 4.3 Quick Setup Wizard

Quick setup wizard guides user to configure the device step by step. User only needs to configure network, SIP server and SIP port in the Quick Setup Wizard interface. Basically, after these three steps, user is able to make voice call via the DAG2000 device.

For the configurations of network, SIP server and SIP port, please refer to 4.4 , 4.5 and 4.8 .

## 4.4 Network

### 4.4.1 Local Network

The device works under the bridge mode, WAN port and LAN port are the same. The device serves as a four-port Ethernet switch. Under this network mode, user only needs to configure the IP address of LAN port and DNS.

Under the route mode, the default IP address of LAN port is a DHCP IP address, while the default IP address of the LAN port is 192.168.11.1.

Figure 4-8 Network Setting under Bridge Mode

**Local Network**

**Network Mode**  Route  Bridge

**Network Configuration**

Obtain an IP address automatically

Use the following IP address

IP Address

Subnet Mask

Default Gateway

PPPoE

Account

Password

Service Name

WAN MTU

**DNS Server**

Obtain DNS server address automatically

Use the following DNS server address

Primary DNS Server

Secondary DNS Server

## 4.4.2 VLAN (Virtual Local Area Network)

In order to control the impacts brought by broadcast storms, you can divide the local-area network into three VLAN groups, including data VLAN, voice VLAN and management VLAN on the **Network** → **VLAN** page.

Management VLAN transmits management-related packets, such as packets of SNMP, TR069, Web and Telnet, while voice VLAN transmits the VoIP signals and voices produced by the device itself. Data VLAN transmits data packets.

Figure 4-9 Configure VLAN

Table 4-2 Explanation of VLAN Parameters

<b>VLAN1/VLAN2/VLAN3</b>	The device supports three VLANs at most. Please enable VLAN according to actual needs.
<b>Data/Voice/Management</b>	Select what kind of messages are allowed to go through this VLAN. For example, if the checkbox on the left of data is selected, it means data messages are subject to the following network setting of this VLAN.
<b>802.1Q VLAN ID(0-4095)</b>	Set an ID to identify a VLAN based on 802.1Q protocol. Range is from 0 to 4095.
<b>802.1p Priority (0-7)</b>	Set the priority of a VLAN based on 802.1P protocol. 0 is the highest priority.
<b>Network Setting</b>	Set a DHCP IP address or static IP address for a VLAN, and set the IP address of the DNS server used by the VLAN.

**【Note】:** After the configurations are finished, you need to restart the device for the configurations to take effect.

### 4.4.3 DHCP Option

When the DAG2000 device works as a DHCP client and applies for an IP address, DHCP server will return packets which include an IP address as well as configuration information of enabled option fields.

The following is the meaning of the option fields involved in DAG2000 (that means the following option fields are enabled, DHCP server will return information of corresponding option fields):

- Option 15: to set a DNS suffix;
- Option 42: to specify NTP server;
- Option 60: to define VCI (vendor class identifier) of DAG2000 on the DHCP server;
- Option 66: to specify TFTP server which will assign software version to DAG2000;
- Option 120: to fetch SIP server address;
- Option 121: to obtain classless static route. DAG2000 will add these static routes to the static route table after it fetches them from DHCP server.

Figure 4-10 Configure DHCP Option

Network Interface: choose which VLAN to send request to DHCP server (or to receive information from DHCP server).

#### 4.4.4 QoS

The DAG2000 device can label QoS priority on the IP messages it sends out, so as to resolve network delay or network congestion. Meanwhile, the device can give different QoS tags for management-related packets of Web/Telnet, voice packets and signal packets.

Figure 4-11 Qos

**Qos**

DSCP code point is used for diffserv setting. It utilizes the first 6 bits of IP ToS. The default values are EF(184), AF1(1), AF2(2), AF3(3), AF4(4), BE(0). You can use different DSCPs for voice or data based on the network provider.

Set DSCP Code/IP ToS  Enable

Manage(WEB/Telnet):

Voice Packet:

Signal Packet:

### 4.4.5 ARP

ARP is address resolution protocol, which helps to get the MAC address of a device through its IP address. Under TCP/IP network environment, each host is assigned with a 32-bit IP address, but MAC address needs to be known for message transmission in the physical network. In the above case, ARP can help convert IP address into MAC address.

Figure 4-12 ARP

**ARP**

Type  Static  Dynamic

	IP Address	MAC Address
<input type="checkbox"/>	172.16.125.125	B8-97-5A-4C-4D-BC

Total: 1 entry Page 1 ▾

## 4.5 SIP Server

SIP server is the main component of VoIP network and is responsible for establishing all SIP calls. SIP server is also called SIP proxy server or register server. Both IPPBX and softswitch can act as the role of SIP server.

Figure 4-13 Configure SIP Server Information

SIP Server

### Primary SIP Server

Primary SIP Server Address

Primary SIP Server Port (Default: 5060)

Registration Expires (Default: 300)  s

Heartbeat  Enable

### Secondary SIP Server

Secondary SIP Server Address

Secondary SIP Server Port (Default: 5060)

Registration Expires (Default: 300)  s

Heartbeat  Enable

### Primary Outbound Proxy

Primary Outbound Proxy Address

Primary Outbound Proxy Port

### Secondary Outbound Proxy

Secondary Outbound Proxy Address

Secondary Outbound Proxy Port

### Registration

Retry Interval when Registration failed  s

Registration Limit (counts/time, time: 0 means unlimited)  /  s

Send SIP Unregistration Request when the Device Restart  Enable

### SIP Transport Type

▼

### Local SIP Port

Use Random Port  Enable

SIP UDP/TCP Local Port

SIP TLS Local Port

Table 4-3 Parameter Explanation of SIP Server

<b>Primary SIP Server Address</b>	The IP address or domain name of the primary SIP server. It is provided by VoIP service provider.
<b>Primary SIP Server port</b>	The service port of the primary SIP server. It is 5060 by default.

<b>Registration Expires</b>	It is used to avoid excessively frequent registrations. When the time that is set expires, the DAG2000 device will send register request to the primary SIP server. The time is 300s by default.
<b>Heartbeat</b>	Heartbeat is used to check the connection between the DAG2000 device and SIP server.
<b>Secondary SIP Server address</b>	The IP address or domain name of the backup SIP server. It is provided by VoIP service provider.
<b>Secondary SIP Server port</b>	Service port of the backup SIP server. It is 5060 by default.
<b>Registration Expires</b>	It is used to avoid excessively frequent registrations. When the time that is set expires, the DAG2000 device will send register request to the backup SIP server. The time is 300s by default.
<b>Secondary SIP heartbeat</b>	Heartbeat is used to check the connection between the DAG2000 device and SIP server.
<b>Outbound Proxy Address</b>	The IP address or domain name of outbound proxy server, which is provided by VoIP service provider.
<b>Outbound Proxy Port</b>	Service port of outbound proxy server. It is 5060 by default.
<b>Retry Interval when Registration failed</b>	The retry interval after a registration fails. Default: 30s
<b>Registration times per second</b>	The maximum number of registrations in a second. 0 means no limitation for registrations.
<b>SIP Transport Type</b>	The way of SIP-based transmission. It can be UDP, TCP, TLS or Automatic. Default: UDP.
<b>Use Random Port</b>	If this parameter is selected, the local port of the DAG2000 device for using SIP services is chosen by random.
<b>SIP UDP/TCP Local Port</b>	The UDP/TCP port of DAG2000 device for using SIP services. Default SIP UDP/TCP local is 5060.
<b>SIP TLS Local Port</b>	The TLS port of DAG2000 device for using SIP services. Default SIP TLS local port is 5061.

Usually, SIP server does not participate in media processing. Under SIP network, media always use end-to-end negotiating. Simple SIP server is only responsible for the establishment, maintenance and cleaning of sessions, while relatively-complex SIP server (SIP PBX) not only provides basic calling and conversational support, but also offers rich services such as Presence, Find-me and Music On Hold.



SIP server based on Linux platform, such as: OpenSER、 sipXecx, VoS, Mera etc.

SIP server based on windows platform, such as :mini SipServer、 Brekeke, VoIPswitch etc.

Carrier-grade soft switch platform, such as Cisco, Huawei, ZTE etc.

## 4.6 IP Profile

IP Profile												
<input type="checkbox"/>	Index	Description	SIP Server	SIP Server Port	Registration Expires	Heartbeat	Primary Outbound Proxy Address	Primary Outbound Proxy Port	Secondary Outbound Proxy Address	Secondary Outbound Proxy Port	DTMF Method	Preferred Vocoder
<input type="checkbox"/>	0	default	172.19.1.24	5060	300	Disable	---	5060	---	5060	RFC2833	G.711U

IP profile is mainly consisting of a series of IP related parameters include SIP server, outbound proxy, DTMF, codecs etc. which are used to configure different parameters for each FXS port.

## 4.7 Tel Profile

Tel Profile												
<input type="checkbox"/>	Index	Description	Work Mode	Voice Output Mod	Config Mode(Gain)	Tx Gain(IP->PSTN)	Rx Gain(PSTN->IP)	Fax Mode	ECM	Rate	Tone Detection by	Switch into Fax Mode When Detected CNG or CED
<input type="checkbox"/>	0	default...	Voice and Fax	Telephone	Basic	+4dB	0dB	Adaptive	Disable	14400bps	Local	Disable

Tel profile is mainly consisting of a series of line related parameters include FAX, gain value etc. which are used to configure different parameters for each FXS port.

## 4.8 Port

A unique SIP account used for registration can be configured for each FXS port of DAG2000 device. Parameters of the SIP account include port number, whether to register, primary display name, primary SIP user ID, primary Authenticate ID, primary Authenticate password, off-hook auto-dial number, caller ID and so on.

Figure 4-14 Configure SIP Account for Port Registration

Port Add

Port	<input style="width: 90%;" type="text" value="0"/>
Disable Port	<input type="checkbox"/>
Registration	<input checked="" type="checkbox"/> Enable
Primary Display Name	<input style="width: 90%;" type="text" value="DinstarTech"/>
Primary SIP User ID	<input style="width: 90%;" type="text" value="DinstarSIP"/>
Primary Authenticate ID	<input style="width: 90%;" type="text" value="DinstarSIP"/>
Primary Authenticate Password	<input style="width: 90%;" type="text" value="12345678"/>
Secondary Display Name	<input style="width: 90%;" type="text"/>
Secondary SIP User ID	<input style="width: 90%;" type="text"/>
Secondary Authenticate ID	<input style="width: 90%;" type="text"/>
Secondary Authenticate Password	<input style="width: 90%;" type="text"/>
Offhook Auto-Dial	<input style="width: 90%;" type="text" value="80000"/>
Auto-Dial Delay Time	<input style="width: 90%;" type="text" value="3"/> s
DND(Do Not Disturb)	<input type="checkbox"/> Enable
Caller-ID	<input checked="" type="checkbox"/> Enable
Number for CFU(Call Forwarding Unconditional)	<input style="width: 90%;" type="text" value="8200"/>
Number for CFB(Call Forwarding Busy)	<input style="width: 90%;" type="text" value="8200"/>
Number for CFNRy(Call Forwarding No Reply)	<input style="width: 90%;" type="text" value="8200"/>
Call Waiting	<input checked="" type="checkbox"/> Enable
Play Call Waiting Tone	<input checked="" type="checkbox"/> Enable

Table 4-4 Explanation of Parameters Related to SIP Registration

<b>Port</b>	The FXS port corresponding to this account
<b>Disable port</b>	Whether to disable port temporarily
<b>Registration</b>	Whether to enable registration for the port
<b>Primary /Secondary SIP Display Name</b>	Description of primary /secondary SIP account. It is used to identify the SIP account.
<b>Primary /Secondary SIP User ID</b>	User ID of the SIP account, which is provided by VoIP service provider (ITSP) for registration. Usually it is in the form of digits

	similar to phone number or an actual phone number.
<b>Primary/Secondary SIP Authenticate ID</b>	SIP service subscriber's authenticate ID used for authentication of registration. It can be identical to or different from SIP User ID.
<b>Primary/Secondary Authenticate password</b>	SIP service subscriber's authenticate ID used for authentication of registration
<b>Offhook Auto-dial</b>	An extension or phone number is pre-assigned here so that the number is automatically dialed as soon as user picks up the phone
<b>Auto-dial Delay Time</b>	How long the auto-dial number is prolonged. If it is set as 3s, the auto-dial number is dialed after 3 seconds pass.
<b>DND (Do Not Disturb)</b>	the phone won't receive any calls if this feature is enabled
<b>Caller ID</b>	Enable or disable caller ID for corresponding port. If it is disabled, the caller ID for the calls through the port won't be displayed.
<b>Number for CFU</b>	Call forward unconditional. All incoming calls will be forwarded to pre-assigned number automatically
<b>Number for CFB</b>	Call forward on busy. If the line is busy, the call will be forwarded to pre-assigned number automatically
<b>Number for CFNRy</b>	Call forward no reply. If the call is not answered, the call will be forwarded to pre-assigned number automatically
<b>Call Waiting</b>	If call waiting is enabled, a special tone is sent if another caller tries to reach you
<b>Play Call Waiting Tone</b>	If call waiting tone is enabled, caller will hear special tone.

## 4.9 Advanced

### 4.9.1 Line Parameter

On the **Advanced** → **line** page, you can configure FXS parameters which include for call progress tone, auto gain control, fax parameters and so on.

Line Parameter	
Call Progress Tone	USA
Ring Back Tone	440,180,480,180,2000,4000,0,0
Busy Tone	480,180,620,180,500,500,0,0
Dial Tone	350,180,440,180,0,0,0,0
Call Waiting Tone	
Call Waiting Tone Duration	800 ms
Call Waiting Tone Gap	2000 ms
Call Waiting Tone Repeat Count	5
Auto Gain Control	<input type="checkbox"/> Enable
<b>Line Parameter</b>	
Work Mode	Voice and Fax
Voice Output Mod	<input checked="" type="radio"/> Telephone <input type="radio"/> Headset
Config Mode(Gain)	<input checked="" type="radio"/> Basic <input type="radio"/> Advanced
Tx Gain(IP->PSTN)	+4dB
Rx Gain(PSTN->IP)	0dB
<b>FAX Parameter</b>	
Fax Mode	Adaptive
Include "a=X-fax" Attribute	<input type="checkbox"/> Enable
Include "a=fax" Attribute	<input type="checkbox"/> Enable
Include "a=X-modem" Attribute	<input type="checkbox"/> Enable
Include "a=modem" Attribute	<input type="checkbox"/> Enable
Include "vbd" Parameter	<input checked="" type="checkbox"/> Enable
Include "silenceSupp" Parameter	<input checked="" type="checkbox"/> Enable
ECM	<input type="checkbox"/> Enable
Rate	14400 bps
Tone Detection by	Local
Switch into Fax Mode When Detected CNG or CED	<input type="checkbox"/>

<b>Call Process Tone</b>	The signal tone standard after a phone is picked up. Choose national standards from the drop-down box. Default value is USA.
<b>Auto Gain Control</b>	Whether to enable automatic gain control
<b>Work Mode</b>	To set the FXS ports work in both Voice and Fax mode. There are several configure options: <ul style="list-style-type: none"> <li>• Voice and FAX: to be able to make call and use FAX service</li> <li>• Voice Only: allows to make call only, Fax doesn't work if you connect a fax machine</li> <li>• Fax Only: allows to make Fax call only.</li> <li>• POS only: allows to connect POS terminal only</li> </ul>
<b>Gain mode</b>	IP to PSTN(RX): adjust gain value to analog phone PSTN to IP(TX): adjust gain value from analog phone
<b>FAX Parameter</b>	The DAG2000-24/32Sdevice supports the three fax modes: T.38

	(IP-based), T.30 (Pass-Through) and Adaptive Fax Mode (automatically match with the peer fax mode).
<b>Fax Mode</b>	There are three fax modes: T.38, T.30(Pass-through), and Adaptive.
<b>Include “a=X-fax” Attribute</b>	If this parameter is enabled, “a=X-fax” attribute will be carried in SDP
<b>Include “a=fax” Attribute</b>	If this parameter is enabled, “a=fax” attribute will be carried in SDP
<b>Include “a=X-modem” Attribute</b>	If this parameter is enabled, “a=X-modem” attribute will be carried in SDP
<b>Include “a=modem” Attribute</b>	If this parameter is enabled, “a=modem” attribute will be carried in SDP
<b>ECM</b>	Whether to enable ‘Error Correction Mode’ (ECM) .
<b>Rate</b>	The rate of sending or receiving fax, default value is 14400bps.
<b>Tone Detection by</b>	Fax sound is detected by caller, callee or automatically.
<b>Switch into Fax Mode When Detect CNG or CED</b>	If this parameter is enabled, the system will switch into fax mode when CNG or CED is detected.

## 4.9.2 FXS Parameter

On the **Advanced**→ **FXS/FXO** page, you can configure FXS parameters which include send polarity reversal, detect hook flash, CID type and so on.

Figure 4-15 Configure FXS Parameters

FxsParam	
Send Polarity Reversal	<input type="checkbox"/> Enable
Detect Hook Flash	<input checked="" type="checkbox"/> Enable
Min Time	<input type="text" value="100"/> ms
Max Time	<input type="text" value="400"/> ms
CID Type	<input type="text" value="FSK"/>
Modulation Type	<input type="text" value="BFSK Bel202"/>
Message Type	<input type="text" value="MDMF"/>
Message Format	<input type="text" value="Display Name and CID"/>
Send CID before Ringing	<input type="checkbox"/> Enable
Delay of Sending CID after Ringing	<input type="text" value="500"/> ms
CFNRy Timeout	<input type="text" value="33"/> s
SLIC Setting	<input type="text" value="600 Ohm"/>
REN	<input type="text" value="4"/>
Long Line Support	<input type="checkbox"/> Enable

Table 4-5 Explanation of FXS Parameters

<b>Send Polarity Reversal</b>	If polarity reversal is enabled, call tolls will be calculated based on the changes in voltage. If polarity reverse is disabled, you need to set the time for offhook detection and call tolls will be calculated starting from the set time.
<b>Detect Hook flash</b>	If 'Detect Hook Flash' is enabled, you need to set a minimum time and a maximum time. If a phone's hook flash is pressed for a time period greater than the set minimum time but less than the maximum time, the action is considered as a 'hook flash' operation. If a phone's hook flash is pressed for more the set maximum time, the action is considered as 'hang up the phone'.
<b>CID Type</b>	There are two CID types, namely DTMF and FSK.
<b>Message Type</b>	There are two call display types including SDMF and MDMF
<b>Message Format</b>	The call display format in analog phone. It can be "Display Name and CID", "CID only", or "Display Name only"; default value is "Display Name and CID"
<b>Send CID before Ringing</b>	If this parameter is enabled, the device send Caller ID to phone before ringing, otherwise the caller ID will be displayed after ringing.
<b>Delay of sending CID after Ringing</b>	The time how long the caller ID will be delayed when the caller ID is set to be displayed after ringing. Default value is 500ms.
<b>CFNRy Timeout</b>	Timeout for 'call forwarding on no answer' service
<b>SLIC Setting</b>	Impedance matched with analog phone.

<b>REN</b>	The maximum number of extensions that can be connected to a single FXS port. If this parameter is configured, you need to restart the device for the configuration to take effect.
<b>Long Line Support</b>	Whether to enable 'Long Analog Extension Line'.

### 4.9.3 Media Parameter

Media parameters mainly include RTP start port, DTMF parameter, preferred Vocoder, etc.

Figure 4-16 Configure Media Parameters

**Media Parameter**

Use Random Port  Enable

RTP Start Port

UDP Checksum Validation  Enable

**DTMF Parameter**

DTMF Method

RFC2833 Payload Type Preferred(Incoming Call)

RFC2833 Payload Type

DTMF Gain

DTMF Send Interval  ms

Send Flash Event  Enable

Send DTMF Tone to Analog When Call in Active  Enable

**Preferred Vocoder**

	Coder Name	Payload Type	Packetization Time(ms)	Rate(kbps)	Silence Suppression
1st	<input type="text" value="G.711U"/>	<input type="text" value="0"/>	<input type="text" value="20"/>	<input type="text" value="64"/>	<input type="text" value="Disable"/>
2nd	<input type="text" value="G.711A"/>	<input type="text" value="8"/>	<input type="text" value="20"/>	<input type="text" value="64"/>	<input type="text" value="Disable"/>
3rd	<input type="text" value="G.729"/>	<input type="text" value="18"/>	<input type="text" value="20"/>	<input type="text" value="8"/>	<input type="text" value="Disable"/>
4th	<input type="text" value="G.723"/>	<input type="text" value="4"/>	<input type="text" value="30"/>	<input type="text" value="63"/>	<input type="text" value="Disable"/>
5th	<input type="text" value="G.726-16"/>	<input type="text" value="111"/>	<input type="text" value="20"/>	<input type="text" value="16"/>	<input type="text" value="Disable"/>
6th	<input type="text" value="G.726-24"/>	<input type="text" value="111"/>	<input type="text" value="20"/>	<input type="text" value="24"/>	<input type="text" value="Disable"/>
7th	<input type="text" value="G.726-32"/>	<input type="text" value="109"/>	<input type="text" value="20"/>	<input type="text" value="32"/>	<input type="text" value="Disable"/>
8th	<input type="text" value="G.726-40"/>	<input type="text" value="108"/>	<input type="text" value="20"/>	<input type="text" value="40"/>	<input type="text" value="Disable"/>

Codecs Preferred

Table 4-6 Explanation of Media Parameters

<b>Use Random Port</b>	If this parameter is enabled, the DAG2000 device will choose a port by random as the start port for RTP.
<b>RTP Start Port</b>	When 'Use Random Port' is not selected, you need to configure a start port for RTP. Default RTP start port is 8000

<b>UDP Checksum Validation</b>	Choose whether to enable header checksum of UDP
<b>DTMF Method</b>	Include SINGAL, INBAND and RFC2833
<b>RFC2833 Payload Type Preferred (Incoming Call)</b>	For an incoming call, choose local or remote RFC2833 payload type as the preferred payload type
<b>RFC2833 Payload Type</b>	Local payload value, default value is 101
<b>DTMF Gain</b>	Default value is 0 DB
<b>DTMF Send Interval</b>	The interval for sending DTMF signal. The default value is 200ms.
<b>Send Flash Event</b>	If this parameter is enabled, the DAG2000 device will send flash-hook event to remote terminal, and thus user does not need to handle it locally
<b>Send DTMF Tone to Analog When Call in Active</b>	If this parameter is enabled, DTMF tone will be sent to analog phone when there is a call
<b>Coder Name</b>	The device supports G.729, G.711U, G.711A, G.723, G.726-16/24/32/40. When outgoing calls are made, G.729 will be used.
<b>Payload Type</b>	Each kind of coding has a unique load value, refer to RFC3551.
<b>Packetization Time</b>	The time for voice packaging
<b>Rate</b>	Voice data flow rate; It is defaulted by system.
<b>Silence Suppression</b>	Default value is 'disabled'. If this parameter is enabled, VoIP transmission bandwidth can be saved, and meanwhile network congestion can be avoided.
<b>Codecs Preferred</b>	Choose local or remote codec as the preferred codec

#### 4.9.4 Service Parameter

Service parameters include timeout for dialing, digitmap, MWI message and so on.

Timeout for Off-hook	<input type="text" value="10"/>	s
Timeout for Dialing	<input type="text" value="4"/>	s
Timeout for Answer(Outgoing Call)	<input type="text" value="55"/>	s
Timeout for Answer(Incoming Call)	<input type="text" value="55"/>	s
No RTP Detected	<input type="checkbox"/> Enable	
Period without RTP Packet	<input type="text" value="60"/>	s



Timeout for off-hook	Mainly used to define a timer that when the user is off hook an analog phone without dial any digits
Timeout for dialing	With the help of dialing timeout, you can limit the time between two digits while users are typing the digits of a number through an extension. If the timeout expires, the gateway will consider the dialing has finished and will try to send message to SIP server. Default value is 4 seconds.
Timeout for answer(Outgoing call)	This parameter determines how long the caller party will wait for answer when making outgoing calls through a phone.
Timeout for answer(Incoming call)	This parameter determines how long the phone rings when there are incoming calls
No RTP Detected	If this parameter is enabled, the situation will be detected when there is no RTP packets received during the set time period.
Period without RTP Packet	The time period when there is no RTP packets received.

SUBSCRIBE for MWI(Message Waiting Indicator)  Enable

MWI Subscription Expires(Default: 3600)  s

Voicemail User ID

Visual MWI Type

<b>SUBSCRIBE for MWI (Message Waiting Indicator)</b>	MWI is aimed to notify user that there is new voicemail. It is realized in the way of NOTIFY.
<b>MWI Subscription Expires</b>	The expiry time of MWI subscription; Default value is 3600s.
<b>Voicemail User ID</b>	The user ID used to access to voicemail
<b>Visual MWI Type</b>	There are two visual MWI Type, namely NEON and FSK

IP-to-IP Call	<input checked="" type="checkbox"/> Enable
Only Accept Calls from ACL(SIP Server or IP Trunk)	<input type="checkbox"/> Enable
Anonymous Call	<input type="checkbox"/> Enable
Reject Anonymous Call	<input type="checkbox"/> Enable
# as Ending Dial Key	<input checked="" type="checkbox"/> Enable
# Escape	<input type="checkbox"/> Enable
Send # when First Dial Number is *	<input checked="" type="checkbox"/> Enable

<b>IP-to-IP Call</b>	If this parameter is enabled, user can dial IP address through a phone to call destination gateway.
<b>Only Accept Call from ACL (SIP server or IP Trunk)</b>	If this parameter is enabled, the device only accepts incoming call from SIP server only. Default value is 'not enable'.
<b>Anonymous Call</b>	If this parameter is enabled, 'anonymous' will be included in SIP message.
<b>Reject Anonymous Call</b>	If this parameter is enabled, all anonymous calls will be rejected. Default value is 'not disable'.
<b># as ending Dial Key</b>	If this parameter is enabled, '#' is used as the end mark for dialing.
<b># Escape</b>	If this parameter is enabled, '#' is considered as a digit of the number that is dialed.
<b>Send '#' when First Dial Number is '**</b>	If this parameter is enabled, '#' will be sent when first dialed digit is '*'.

### Voicemail instructions:

Here takes the DAG2000-32S device together with Elastix as the example to introduce how voicemail works in the device.

- (1) After the device registers to Elastix server, enable the voicemail function in Elastix for the corresponding extension number and then set password. As below:

**Voicemail & Directory**

---

Status

Voicemail Password

Email Address

Pager Email Address

Email Attachment  yes  no

Play CID  yes  no

Play Envelope  yes  no

Delete Voicemail  yes  no

IMAP Username

IMAP Password

VM Options

VM Context

VmX Locator

---

(2) Check feature code in Elastix and change it if necessary. Its default feature code setting is as follows:

#### Voicemail

Dial Voicemail	<input type="text" value="*98"/>	<input checked="" type="checkbox"/>	<input type="text" value="Enabled"/>
My Voicemail	<input type="text" value="*97"/>	<input checked="" type="checkbox"/>	<input type="text" value="Enabled"/>

(3) On the Web interface of DAG2000-32S, click **Advanced** → **SIP Parameter** in the navigation tree and then enter voicemail User ID.

SUBSCRIBE for MWI(Message Waiting Indicator)	<input checked="" type="checkbox"/> Enable
MWI Subscription Expires(Default: 3600)	<input type="text" value="3600"/> s
Voicemail User ID	<input type="text"/>
Visual MWI Type	<input type="text" value="NEON"/>

(4) Set ringing time in Elastix. Elastix will prompt user to leave a message after the corresponding extension rings 15 seconds (by default). Then the Elastix sever will record the message. Related setting is shown as follows:

**Voicemail**

Ringtime Default:   
 Direct Dial Voicemail Prefix:   
 Direct Dial to Voicemail message type:   
 Optional Voicemail Recording Gain:   
 Do Not Play "please leave message after tone" to caller

(5) Dial \*200# on the extension which is connected to DAG2000-32S, and then dial voicemail user ID and password for authentication. After that user will hear voice message.

**Digit Map**

Match Failed(When the registration is successful)

`[*]T[*][*]*x.T[*]x.[*][*]xx#[*]xx#[*][0-9*]x[0-9*].x#|x.#|x.T`

Digitmap is used for number dialing of calls through FXS ports of the DAG2000 device.

Supported Objects	Digit	0-9
	T	Timer
	DTMF	A digit, a timer, or one of the symbols of A, B, C, D, #, or *
Range	[ ]	One or more DTMF symbols enclosed in the [], but only one DTMF symbol can be selected
Range	()	One or more expressions enclosed the (), but only one can be selected
Separator		Separate expressions or DTMF symbols.
Subrange	-	Two digits separated by hyphen (-) which matches any digit between and including the two digits.
Wildcard	x	Matches any digit of 0 to 9
Modifiers	.	Matches 0 or more times of the preceding element
Modifiers	?	Matches 0 or 1 times of the preceding element

## 4.9.5 SIP Parameter

SIP parameters include attended transfer trigger, early media, session timer, heartbeat interval and so on.

Figure 4-17 Configure SIP Parameters

SIP Compatibility	
RFC3407 Support	<input type="checkbox"/> Enable
"From" SIP URI includes "user=phone"	<input type="checkbox"/> Enable
INVITE with "P-Preferred-Identity" Header (RFC3325)	<input type="checkbox"/> Enable
Value of "Refer To" refers to "Contact"	<input type="checkbox"/> Enable
Third Party Do Not Send 18x Response	<input type="checkbox"/> Enable
REFER Delay	<input type="checkbox"/> Enable
Send BYE when Recv REFER Response(Unattended)	<input type="checkbox"/> Enable
Send New REGISTER when Recv 423 Response	<input checked="" type="checkbox"/> Enable
Cseq Start with 1	<input type="checkbox"/> Enable
Forbid Invalid m=line in reINVITE	<input type="checkbox"/> Enable
Call Waiting Response Code	180 Response
RTP Mode in SDP when Call Holding	sendonly
Support Call Waiting of Huawei IPPBX	<input type="checkbox"/> Enable
Accept Orphan 200 Ok	<input type="checkbox"/> Enable
Called Number Preferred	P-Called-Party-ID Header
Caller-ID Preferred	P-Asserted-Identity Header
Check SDP Strictly	<input checked="" type="checkbox"/> Enable
Report SDP Whatever	<input type="checkbox"/> Enable
18x Response Preferred(Without Effective P-Early-Media)	18x Response with SDP
FlashHook Operation Mode	Mode one
Attended Transfer Trigger	Onhook
Multipart Payload Support	<input type="checkbox"/> Enable
Local Extension is Preferred(Tel in)	<input type="checkbox"/> Enable

Table 4-7 Explanation of SIP Parameters

<b>RFC3407 Support</b>	Whether to enable RFC3407 support. If this parameter is enabled, the device will support RFC3407 which defines the SDP capability of backward compatibility.
<b>URI Includes "user=phone"</b>	If this parameter is enabled, 'user=phone' will be contained in URI. When calls are routed to PSTN network, the called number will be got from user name. Default value is 'not enable'.
<b>INVITE with "P-Preferred-Identity" Header (RFC3325)</b>	If this parameter is enabled, "P-Preferred-Identity" header will be added in INVITE message for anonymous call (Support RFC3325).
<b>Only Accept Call from ACL (SIP server or IP Trunk)</b>	If this parameter is enabled, the device only accepts incoming call from SIP server only. Default value is 'not enable'.
<b>Value of "Refer To" refers to</b>	If this parameter is enabled, 'contract header' needs to be

<b>“Contact”</b>	filled in in the ‘refer to’ field of a SIP message.
<b>Third Party Do Not Send 18x Response</b>	If this parameter is enabled, the third party will not send 18x response during an attended transfer.
<b>Send BYE when Recv REFER Response (Unattended)</b>	If this parameter is enabled, the third party will send BYE to release session after receiving REFER during a blind transfer.
<b>Send New REGISTER when Recv 423 Response</b>	If this parameter is enabled, the value of ‘expires’ header will be automatically updated and REGISTER will be re-sent after receiving of 423 response.
<b>CSeq Start with 1</b>	If this parameter is enabled, the value of CSeq starts with ‘1’.
<b>Forbid Invalid m=line in reINVITE</b>	If this parameter is enabled, the device will prevent ‘invalid m=line’ from being carried in the SDP of re-INVITE.
<b>Call Confirm Tone</b>	If this parameter is enabled, ring-back tone will be played when a call does not receive 180x response.
<b>Call Waiting Response Code</b>	User can choose 180 or 182 as call waiting response code
<b>RTP Mode in SDP when Call Holding</b>	Use ‘send only’ or ‘inactive’ as RTP mode during call holding.
<b>Support Call Waiting of Huawei IPPBX</b>	If this parameter is enabled, the device will support call waiting of Huawei IPPBX.
<b>Accept Orphan 200 OK</b>	If this parameter is enabled, the DAG2000 device will support different ‘to-tag 200 OK’ in an INVITE session.
<b>Called Number Preferred</b>	Choose P-Called-Party-ID header or Request-Line
<b>Caller-ID Preferred</b>	Choose P-Asserted-Identity header or From Header
<b>Report SDP Whatever</b>	If this parameter is enabled, SDP will be reported anytime
<b>18x Response Preferred</b>	Choose ‘18x Response with SDP’, ‘Last 18x Response’ or ‘Local Ring Tone Only’
<b>Flashhook Operation Mode</b>	Choose Mode one, Mode two or Mode three
<b>Attended Transfer Trigger</b>	Choose ‘Onhook’ or ‘Flashhook +4’

Figure 4-18 Configure Default SIP Parameters &amp; Early Media

PRACK(RFC3262)	<input type="checkbox"/> Enable
PRACK Only for 18x with SDP	<input type="checkbox"/> Enable
Early Media	<input checked="" type="checkbox"/> Enable
Early Answer	<input type="checkbox"/> Enable
Session Timer(RFC4028)	<input type="checkbox"/> Enable
Session-Expires	<input type="text" value="1800"/> s
Min-SE	<input type="text" value="1800"/> s
Session Refresh Method	<input type="text" value="INVITE"/>

Table 4-8 Explanation of Default SIP Parameters &amp; Early Media Parameters

<b>Domain Query Type</b>	There are two modes: A QUERY and SRV QUERY. Default is 'A QUERY'.
<b>Domain Re-resolution Interval</b>	The interval for re-parsing domain name. Range is from 0 to 3600s. Default value is 0, which means no re-parsing.
<b>DNS cache</b>	If this parameter is enabled, the DAG2000 device will cache the DNS query results.
<b>PRACK(RFC3262)</b>	If this parameter is enabled, the DAG2000 device supports reliable transmission of provisional response
<b>PRACK Only for 18x with SDP</b>	If this parameter is enabled, only PRACK will be sent when there's SDP in 18x response
<b>Early Media</b>	If this parameter is enabled, the DAG2000 device supports the receiving of Early Media.
<b>Early Answer</b>	If this parameter is enabled, the DAG2000 device supports early answer
<b>Answer Update without Offer (for Port Group)</b>	If this parameter is enabled, the system will update answer proactively although no offer is received.
<b>Session Timer (RFC4028)</b>	Whether to enable 'session timer', default value is 'not enable'.
<b>Session-Expires</b>	The interval for refreshing session; default value is 1800s. The Session-Expires header field conveys the session interval for a SIP session.
<b>Min-SE</b>	The minimum interval for refreshing session; default value is 1800s. The Min-SE header field indicates the minimum value for the session interval.
<b>Session Refresh Method</b>	The method to refresh session; default value is INVITE.

Figure 4-19 Configure Timer in SIP Protocol

T1	<input type="text" value="500"/>	ms
T2	<input type="text" value="4000"/>	ms
T4	<input type="text" value="5000"/>	ms
Max Timeout	<input type="text" value="32000"/>	ms
Heartbeat Interval(1 - 3600)	<input type="text" value="10"/>	s
Heartbeat Timeout(4 - (64*T1-1))	<input type="text" value="16"/>	s
Username of OPTION(Heartbeat) for 'SIP Server'	<input type="text" value="heartbeat"/>	
Username of OPTION(Heartbeat) for 'IP Trunk'	<input type="text" value="heartbeato"/>	
Release all call when Heartbeat Timeout	<input type="checkbox"/>	Enable
Request/Response Message Configuration		
Via of Message	<input type="text" value="LAN Address"/>	

Table 4-9 Explanation of Timer Parameters in SIP Protocol

<b>T1</b>	Value of T1 timer in SIP protocol, default is 500ms
<b>T2</b>	Value of T2 timer in SIP protocol, default is 4000ms
<b>T4</b>	Value of T4 timer in SIP protocol, default is 5000ms
<b>Max Timeout</b>	The max timeout of sending or receiving SIP messages, default is 32000ms
<b>Heartbeat Interval</b>	The interval for sending heartbeat message, Default is 10s.
<b>Heartbeat Timeout</b>	The timeout for heartbeat message to be sent, default to 16s
<b>Username of OPTION(Heartbeat) for "SIP Server"</b>	The user ID part of OPTION SIP message in the heartbeat request for SIP server
<b>Username of OPTION(Heartbeat) for "IP TRUNK"</b>	The user ID part of OPTION SIP message in the heartbeat request for IP trunk
<b>Via of Request/Response Message</b>	Choose 'LAN address' or 'WAN address' to be carried in the 'Via' header of request/response message



## 4.9.6 NAT Parameter

NAT Config		
NAT Traversal	Dynamic NAT	
Via of Message	<input checked="" type="radio"/> Local Address	<input type="radio"/> NAT Address
Contact of Message	<input type="radio"/> Local Address	<input checked="" type="radio"/> NAT Address
SDP of Message	<input checked="" type="radio"/> Local Address	<input type="radio"/> NAT Address

**NAT Traversal (Network Address Translator Traversal)** is a computer networking technique of establishing and maintaining Internet protocol connections across gateways that implement network address translation (NAT). NAT breaks the principle of end-to-end connectivity originally envisioned in the design of the Internet.

**STUN (Simple Traversal of UDP over NATs)** is a lightweight protocol that allows applications to discover the presence and types of NATs and firewalls between them and the public Internet. It also provides the ability for applications to determine the IP addresses allocated to them by the NAT. STUN works with many existing NATs, and does not require any special behavior from them. STUN doesn't support TCP connection and H.323.

## 4.9.7 Speed dial

Speed Dial		
Index	Speed Dial Number	Original Number
---	---	---

Speed dial is a function that is available on telephones which provides an easy method of calling a telephone number by pressing fewer digits on the keypad. The tool enables one to save, organize, and have easy and quick access to regularly dialed numbers.

Speed Dial - Add	
Index	0
Speed Dial Number	10
Original Number	888123

Speed Dial			
	Index	Speed Dial Number	Original Number
<input type="checkbox"/>	0	10	888123

Total: 1 Entry

## 4.9.8 Feature Code

Feature Code			
Feature	Codes	Use Default	Status
<b>Device Function</b>			
Inquiry LAN IP	*158#	<input checked="" type="checkbox"/>	Enable <input type="button" value="v"/>
Inquiry Phone Number	*114#	<input checked="" type="checkbox"/>	Enable <input type="button" value="v"/>
Inquiry PortGroup Number	*115#	<input checked="" type="checkbox"/>	Enable <input type="button" value="v"/>
Remove Login Limit	*154#	<input checked="" type="checkbox"/>	Enable <input type="button" value="v"/>
Setting IP Mode	*150*	<input checked="" type="checkbox"/>	Enable <input type="button" value="v"/>
Configure IP Address	*152*	<input checked="" type="checkbox"/>	Enable <input type="button" value="v"/>
Network Subnet Mask Configure	*153*	<input checked="" type="checkbox"/>	Enable <input type="button" value="v"/>
Network Gateway Configure	*156*	<input checked="" type="checkbox"/>	Enable <input type="button" value="v"/>
Port Voice Up	*170#	<input checked="" type="checkbox"/>	Enable <input type="button" value="v"/>
Port Voice Down	*171#	<input checked="" type="checkbox"/>	Enable <input type="button" value="v"/>
Reset Basic Configuration	*165*	<input checked="" type="checkbox"/>	Enable <input type="button" value="v"/>
Reset Factory Configuration	*166*	<input checked="" type="checkbox"/>	Enable <input type="button" value="v"/>
Restart Device	*111#	<input checked="" type="checkbox"/>	Enable <input type="button" value="v"/>
<b>Call Function</b>			
Call by IP	*47*	<input checked="" type="checkbox"/>	Enable <input type="button" value="v"/>
Call Waiting Activate	*51#	<input checked="" type="checkbox"/>	Enable <input type="button" value="v"/>
Call Waiting Deactivate	*50#	<input checked="" type="checkbox"/>	Enable <input type="button" value="v"/>
Blind Transfer	*87*	<input checked="" type="checkbox"/>	Enable <input type="button" value="v"/>
Call Forward Unconditional Activate	*72*	<input checked="" type="checkbox"/>	Enable <input type="button" value="v"/>
Call Forward Unconditional Deactivate	*73#	<input checked="" type="checkbox"/>	Enable <input type="button" value="v"/>
Call Forward Busy Activate	*90*	<input checked="" type="checkbox"/>	Enable <input type="button" value="v"/>
Call Forward Busy Deactivate	*91#	<input checked="" type="checkbox"/>	Enable <input type="button" value="v"/>
Call Forward No Reply Activate	*92*	<input checked="" type="checkbox"/>	Enable <input type="button" value="v"/>
Call Forward No Reply Deactivate	*93#	<input checked="" type="checkbox"/>	Enable <input type="button" value="v"/>
Do Not Disturb Activate	*78#	<input checked="" type="checkbox"/>	Enable <input type="button" value="v"/>
Do Not Disturb Deactivate	*79#	<input checked="" type="checkbox"/>	Enable <input type="button" value="v"/>
Dial Voicemail	*200#	<input checked="" type="checkbox"/>	Enable <input type="button" value="v"/>
<b>DTMF Function</b>			
Call Holding	*#	<input checked="" type="checkbox"/>	Enable <input type="button" value="v"/>
Call Switch	##	<input checked="" type="checkbox"/>	Enable <input type="button" value="v"/>

Inquiry LAN port IP address

Dial\*158# to obtain device's LAN port IP address

Inquiry Phone Number	Dial*114# to obtain port account
Inquiry PortGroup Number	Dial *115# to obtain port group number
Setting IP Mode	*150*0#, means pppmodem, *150*1#, means static IP, *150*2#, means obtain IP address by DHCP, *150*3#, means pppoe.
Network Work Mode	*157*0#, set network work mode to routing mode; *157*1#, set network work mode to bridge mode
Configure IP Address	*152*+IP, set gateway IP address
Network subnet mask configure	*153*+subnet mask, set gateway subnet mask
Network Gateway Configure	*156*+gateway IP, set gateway
Renew DHCP	*193#, set dynamic IP again
Reset Basic Configuration	Dial *165*000000# to restore default username/password and network configuration
Reset Factory Configuration	*166*000000#, reset factory
Restart Device	*111#, restart device
Call holding	During a call, dial*# into call hold. (Recovery the call through hook flash or *#)
Call by IP	Directly dial the end user IP to call
Call Waiting Activate	*51#, enable call waiting function
Call Waiting Deactivate	*50#, forbid call waiting function
Blind Transfer	If the call transfer to 801, first hook flash and then dial the *87 * 801#
Call Forward Unconditional Activate	*72*+ phone number#, transfer the call from the phone number
Call Forward Unconditional Deactivate	*73#, forbid call forward unconditional
Call Forward Busy Activate	*90*+ forward busy number#
Call Forward Busy Deactivate	*91#, forbid call forward busy

---

Call Forward No Reply Activate	*92*+ forward no reply number#
Call Forward No Reply Deactivate	*93#, close this function
Do Not Disturb Activate	*78#, enable DND function
Do Not Disturb Deactivate	*79#, close DND function
Dial Voicemail	*200#, visit voice mail box

### 4.9.9 System Parameter

System parameters include NTP, daylight saving time, daily reboot time, web parameter, telnet parameter and remote management.

**NTP (Network Time Protocol)** is a computer time synchronization protocol.

Figure 4-20 Configure System Parameters

System Config

**Hint Language** English ▼

**NTP**  Enable

Primary NTP Server Address us.pool.ntp.org

Primary NTP Server Port 123

Secondary NTP Server Address 64.236.96.53

Secondary NTP Server Port 123

SYN Interval 3600 s

Time Zone GMT-6:00 (US Central Time, Chicago) ▼

**Daylight Saving Time**  Enable

**Daily Reboot**  Enable

Reboot Time 0 : 0

**Log**

Summary  Enable

System Log  Enable

**Network Diagnose**

The local network fault detection (Please close for network disable ping)  Enable

The local network interruption detection  Enable

**WEB Parameter**

WEB Port 80

SSL Port 443

**Telnet Parameter**

Telnet Port 23

Table 4-10 Explanation of System Parameters

<b>NTP</b>	To enable or disable NTP
<b>Primary NTP server address</b>	The IP address of primary NTP server; default IP address is us.pool.ntp.org.
<b>Primary NTP server port</b>	The service port of primary NTP server; default port is 123.
<b>Secondary NTP server address</b>	The IP address of secondary NTP server ; Default IP address is 64.236.96.53

<b>Secondary NTP server port</b>	The service port of secondary NTP server; Default port is 123
<b>SYN Interval</b>	The interval to synchronize the time of the DAG2000-24/32S. Default value is 3600s.
<b>Time Zone</b>	The time zone of the device; Default configuration is United States central time, Chicago.
<b>Daylight Saving Time</b>	Enable or disable daylight saving time
<b>Daily Reboot</b>	Whether to enable daily reboot
<b>Reboot time</b>	The time to reboot the device daily
<b>WEB Port</b>	The web port of the device; Default port is 80
<b>SSL Port</b>	The SSL port; Default is 443
<b>Telnet port</b>	Listening port of telnet service; Default port is 23

**【Note】** After Web port and Telnet port are configured, please restart the device for the configurations to take effect.

## 4.10 Call & Routing

### 4.10.1 Port Group

When two or more FXS ports need to register with a same SIP account, you can group the ports together and then set an account for the group on the **Call & Routing → Port Group** page.

Parameters of port group include registration, primary display name, primary SIP user id, primary authentication ID and password, secondary display name, secondary SIP user id, secondary authentication ID and password, off-hook auto dial, auto dial delay time, port select, etc.

Figure 4-21 Add Port Group

Port Group Add

Index	<input style="width: 90%;" type="text" value="0"/>
Registration	<input checked="" type="checkbox"/> Enable
Description	<input style="width: 90%;" type="text" value="PortGroup1"/>
Primary Display Name	<input style="width: 90%;" type="text" value="52000"/>
Primary SIP User ID	<input style="width: 90%;" type="text" value="52000"/>
Primary Authenticate ID	<input style="width: 90%;" type="text" value="52000"/>
Primary Authenticate Password	<input style="width: 90%;" type="text" value="123456"/>
Secondary Display Name	<input style="width: 90%;" type="text"/>
Secondary SIP User ID	<input style="width: 90%;" type="text"/>
Secondary Authenticate ID	<input style="width: 90%;" type="text"/>
Secondary Authenticate Password	<input style="width: 90%;" type="text"/>
Offhook Auto-Dial	<input style="width: 90%;" type="text" value="8000"/>
Auto-Dial Delay Time	<input style="width: 90%;" type="text" value="3"/>
Port Select	<input style="width: 90%;" type="text" value="Cyclic Ascending"/>
Pick Up on Group	<input style="width: 90%;" type="text" value="*#"/>
Port	<input type="button" value="Click to Select Ports for this Group"/>

Table 4-11 Parameter Explanation of Port Group

<b>Index</b>	The NO. of the port group; It uniquely identifies a route.
<b>Description</b>	The description of the port group; it is used to identify the port group.
<b>Primary/Secondary Display Name</b>	<p>Display name of the port group, which will be used in SIP message, for example:</p> <pre>INVITE sip:bob@biloxi.com SIP/2.0 Via: SIP/2.0/UDPpc33.atlanta.com;branch=z9hG4bK776asdhd Max-Forwards: 70 To: Bob &lt;sip:bob@biloxi.com&gt; From: Alice &lt;sip:alice@atlanta.com&gt;;tag=1928301774</pre> <p>Here Bob and Alice is the display name</p>
<b>Primary/Secondary SIP User ID</b>	User ID of this SIP account, which is provided by VoIP service provider (ITSP). It is usually in the form of digit similar to phone number or an actual phone number.



<b>Primary/Secondary Authenticate ID</b>	SIP service subscriber's ID for authentication; it can be identical to or different from SIP User ID.
<b>Primary/Secondary Authenticate Password</b>	SIP service subscriber's password for authentication
<b>Offhook Auto-Dial</b>	An extension or phone number is pre-assigned here so that the number is automatically dialed as soon as user picks up the phone
<b>Auto-dial Delay time</b>	How long auto-dialing will be delayed
<b>Port Select</b>	<p>It specifies the policy for selecting a port for ringing in the port group</p> <ul style="list-style-type: none"> <li>• Ascending: the device always selects a port from the minimum number.</li> <li>• Cyclic ascending: the device always selects a port from a number next to the number selected last time. If the maximum number was selected last time, the next selected number is the minimum number. The sequence moves in cycles like this.</li> <li>• Descending: the device always selects a port from the maximum number.</li> <li>• Cyclic descending: the device always selects a port from a number next to the number selected last time. If the minimum number was selected last time, the next selected number is the maximum number. The sequence moves in cycles like this.</li> <li>• Group ring: all ports ring at the same time</li> </ul>
<b>Pickup UP on group</b>	When one port rings, user can dial '*#' to pick up the call from other ports under the same port group.
<b>Port</b>	Select ports for this port group

## 4.10.2 IP Trunk

A peer-to-peer VoIP call occurs when two VoIP phones communicate directly over IP network without IP PBXs between them. IP trunk helps establish peer-to-peer call between gateway and VoIP phones. IP trunk will be used in routing configuration.

Figure 4-22 Configure IP Trunk

Table 4-12 Explanation of IP Trunk Parameters

<b>Index</b>	The No. of the IP trunk; range is from 0 to 127.
<b>Description</b>	The description of the IP trunk; it is used to identify the IP trunk.
<b>Remote Address</b>	IP address or domain name of the peer device
<b>Remote Port</b>	SIP port of the peer device
<b>Heartbeat</b>	Whether to enable the 'Heartbeat' function for the IP trunk. Default value is 'not enable'. If heartbeat is enabled, the device will send "OPTION" to the peer device.

### 4.10.3 Routing Parameter

Routing parameter determines a call is routed before or after manipulation.

Figure 4-23 Configure Routing Parameter

Table 4-13 Explanation of Routing Parameters

<b>IP →IP Routing</b>	Choose whether to enable IP → IP routing. If this parameter is enabled, calls from IP network will be routed to IP phones.
-----------------------	--

Calls from IP	Choose calls from IP network are routed before manipulation or after manipulation.
Calls from Analog Line	Choose calls from analog lines are routed before manipulation or after manipulation.

#### 4.10.4 IP → Tel Routing

Calls from IP network can be routed to FXS port or port group of the DAG2000 device through IP → Tel routing.

Figure 4-24 Add IP → Tel Route

The screenshot shows the 'IP->Tel Routing Modify' web interface. It contains the following fields and options:

- Index:** Text input field containing '127'.
- Description:** Text input field containing 'IP->TelRoute1'.
- Calls from:** Radio button for 'IP Trunk' (selected) and 'SIP Server'. A dropdown menu next to 'IP Trunk' shows '127 <95.98>'.
- Caller Prefix:** Text input field containing 'any'.
- Callee Prefix:** Text input field containing 'any'.
- Calls to:** Radio button for 'Port' (selected) and 'Port Group'. A dropdown menu next to 'Port' shows '0', and a dropdown menu next to 'Port Group' shows '1 <056002>'.

At the bottom of the form are three buttons: 'Save', 'Reset', and 'Cancel'.

Table 4-14 Parameter Explanation of IP → Tel Routes

<b>Index</b>	Index of the IP → Tel routing; range is from 0 to 127; 0 is the highest priority.
<b>Description</b>	Description of the IP → Tel routing; it is used to identify the IP → Tel routing.
<b>Calls from</b>	Choose calls from IP trunk or SIP server; 'any' means any IP addresses.
<b>Caller Prefix</b>	The prefix of the caller number, which helps match routing exactly. Its length is less than or equal to the caller number. For example, if caller number is 2001, the caller prefix can be 200 or 2. 'Any' means the prefix matches any caller number.
<b>Callee Prefix</b>	The prefix of the called number, which helps match routing exactly. Its length is less than or equal to the called number. If the called number is 008675526456659, the called prefix can be 0086755 or 00., "any" means the prefix matches any called number
<b>Calls to</b>	Which port or port group to which calls are routed.

## 4.10.5 Tel → IP/Tel Routing

Calls from the FXS port or port group can be routed to IP trunk or ports of SIP server/other device through Tel →IP/Tel routing.

Figure 4-25 Add Tel →IP/Tel Route

The screenshot shows a web interface for adding a Tel →IP/Tel route. The form is titled "Tel->IP/Tel Routing Add". It contains the following fields and options:

- Index:** A dropdown menu with the value "127".
- Description:** A text input field containing "Tel->IPRoute1".
- Calls from:** Radio buttons for "Port" and "Port Group". "Port Group" is selected. A dropdown menu shows "1 <056002>".
- Caller Prefix:** A text input field containing "any".
- Callee Prefix:** A text input field containing "any".
- Calls to:** Radio buttons for "Port", "Port Group", "IP Trunk", and "SIP Server". "IP Trunk" is selected. A dropdown menu shows "127 <95.98>".

At the bottom of the form are three buttons: "Save", "Reset", and "Cancel".

Table 4-15 Explanation of Tel →IP/Tel Route

<b>Index</b>	The index of this Tel →IP/Tel routing; range is from 0 to 127. Each index cannot be used repeatedly. Routing priority: 0 is the highest priority.
<b>Description</b>	The description of this Tel →IP/Tel routing; it is used to identify the routing.
<b>Calls From</b>	Choose calls are from a port or a port group
<b>Caller Prefix</b>	The prefix of the caller number, which helps match routing exactly. Its length is less than or equal to the caller number. For example, if caller number is 2001, the caller prefix can be 200 or 2. 'any' means the prefix matches any caller number.
<b>Callee Prefix</b>	The prefix of the called number, which helps match routing exactly. Its length is less than or equal to the called number. If the called number is 008675526456659, the called prefix can be 0086755 or 00. 'any' means the prefix matches any called number.
<b>Calls to</b>	Choose calls are routed to a port, port group, IP trunk or SIP server

## 4.10.6 IP → IP Routing

Calls from IP trunk can be routed to a different IP trunk through IP →IP routing. Configurations on this page won't take effect unless IP →IP routing has been enabled on the **Call & Routing →Routing Parameter** page.

Figure 4-26 Add IP →IP Route

The screenshot shows a web interface for adding an IP →IP routing rule. The form is titled "IP->IP Routing Add" and contains the following fields:

- Index:** A dropdown menu with the value "127".
- Description:** A text input field containing "IP->IPRoute1".
- Calls from:** A radio button selected for "IP Trunk" and a dropdown menu with the value "127 <95.98>".
- Caller Prefix:** A text input field containing "any".
- Callee Prefix:** A text input field containing "any".
- Calls to:** A radio button selected for "IP Trunk" and a dropdown menu with the value "126 <IPTrunk2>".

At the bottom of the form, there are three buttons: "Save", "Reset", and "Cancel".

Table 4-16 Parameter Explanation of IP →IP Route

<b>Index</b>	The index of this IP →IP routing; range is from 0 to 127. Each index cannot be used repeatedly. Routing priority: 0 is the highest priority.
<b>Description</b>	The description of this IP →IP routing; it is used to identify the routing.
<b>Calls From</b>	Choose calls are from which IP trunk. 'Any' means calls are from any IP addresses.
<b>Caller Prefix</b>	The prefix of the caller number, which helps match routing exactly. Its length is less than or equal to the caller number. For example, if caller number is 2001, the caller prefix can be 200 or 2. 'any' means the prefix matches any caller number.
<b>Callee Prefix</b>	The prefix of the called number, which helps match routing exactly. Its length is less than or equal to the called number. If the called number is 008675526456659, the called prefix can be 0086755 or 00. 'any' means the prefix matches any called number.
<b>Calls to</b>	Choose calls are routed to which IP trunk.

## 4.11 Manipulation

Number manipulation refers to the change of a called number or a caller number during calling process when the called number or the caller number matches the preset rules.

### 4.11.1 IP → Tel Callee

On the **IP → Tel Callee** page, you can set rules for manipulating the called number of IP → Tel calls.

Figure 4-27 Add IP →Tel Called Number Manipulation

The screenshot shows the 'IP->Tel Callee Add' configuration form. The fields are as follows:

- Index:** 127
- Description:** IP->Tel-Manipulation1
- Calls from:** IP Trunk (unselected), SIP Server (selected). Value: 126 <IPTrunk2>
- Caller Prefix:** any
- Callee Prefix:** any
- Calls to:** Port (selected), Port Group (unselected). Value: 0
- Stripped Digits from Left:** 2
- Stripped Digits from Right:** (empty)
- Prefix to Add:** 134
- Suffix to Add:** (empty)

Buttons: Save, Reset, Cancel

Table 4-17 Explanation of Parameters for IP →Tel Called Number Manipulation

<b>Index</b>	The index of this manipulation; range is from 0 to 127. Each index cannot be used repeatedly. 0 is the highest priority
<b>Description</b>	Description of this manipulation; it is used to identify this manipulation.
<b>Calls From</b>	Determine the calls come from IP trunk or SIP server
<b>Caller Prefix</b>	Set a prefix for caller number. The prefix's length is less than or equal to that of the caller number, which helps to match the caller number of this call. If caller number is 2001, the caller prefix can be 200 or 2. "any" means match any caller number.
<b>Callee Prefix</b>	Set a prefix for called number. The prefix's length is less than or equal to called number, which helps to match the called number. If called number is 008675526456659, the called prefix can be 0086755 or 00. "any" means match any called number.
<b>Calls to</b>	Determine the call is routed to a port or a port group.
<b>Stripped Digits from Left</b>	The number of digits which are lessened from the left of the called number

<b>Stripped Digits from Right</b>	The number of digits which are lessened from the right of the called number
<b>Prefix to Add</b>	The prefix added to the called number after its digits are lessened.
<b>Suffix to Add</b>	The suffix added to the called number after its digits are lessened.

## 4.11.2 Tel → IP/Tel Caller

On the **Tel → IP/Tel Caller** page, you can set rules for manipulating the caller number of Tel → IP/Tel calls.

Figure 4-28 Add Tel → IP/Tel Caller Number Manipulation

Table 4-18 Explanation of Parameters for IP → Tel Called Number Manipulation

<b>Index</b>	The index of this manipulation; range is from 0 to 127. Each index cannot be used repeatedly. 0 is the highest priority
<b>Description</b>	Description of this manipulation; it is used to identify this manipulation.
<b>Calls From</b>	Determine the calls come from a port or a port group.
<b>Caller Prefix</b>	Set a prefix for caller number. The prefix's length is less than or equal to that of the caller number, which helps to match the caller number of this

	call. If caller number is 2001, the caller prefix can be 200 or 2. 'any' means match any caller number.
<b>Callee Prefix</b>	Set a prefix for called number. The prefix's length is less than or equal to called number, which helps to match the called number. If called number is 008675526456659, the called prefix can be 0086755 or 00. 'any' means match any called number.
<b>Calls to</b>	Determine the call is routed to a port, a port group, an IP trunk or a SIP server.
<b>Stripped Digits from Left</b>	The number of digits which are lessened from the left of the caller number
<b>Stripped Digits from Right</b>	The number of digits which are lessened from the right of the caller number
<b>Prefix to Add</b>	The prefix added to the caller number after its digits are lessened.
<b>Suffix to Add</b>	The suffix added to the caller number after its digits are lessened.

### 4.11.3 Tel → IP/Tel Callee

On the **Tel → IP/Tel Callee** page, you can set rules for manipulating the called number of Tel → IP/Tel calls.



Figure 4-29 Add Tel → IP/Tel Callee Number Manipulation

Tel->IP/Tel Callee Add

Index	127 ▼
Description	Tel->IP-Manipulation3
Calls from	<input checked="" type="radio"/> Port 0 ▼
	<input type="radio"/> Port Group 1 <056002> ▼
Caller Prefix	any
Callee Prefix	any
Calls to	<input type="radio"/> Port 0 ▼
	<input type="radio"/> Port Group 1 <056002> ▼
	<input checked="" type="radio"/> IP Trunk 126 <IPTrunk2> ▼
	<input type="radio"/> SIP Server
Stripped Digits from Left	0
Stripped Digits from Right	
Prefix to Add	0755
Suffix to Add	

Table 4-19 Explanation of Parameters for Tel → IP/Tel Callee Number Manipulation

<b>Index</b>	The index of this manipulation; range is from 0 to 127. Each index cannot be used repeatedly. 0 is the highest priority
<b>Description</b>	Description of this manipulation; it is used to identify this manipulation.
<b>Calls From</b>	Determine the calls come from a port or a port group.
<b>Caller Prefix</b>	Set a prefix for caller number. The prefix's length is less than or equal to that of the caller number, which helps to match the caller number of this call. If caller number is 2001, the caller prefix can be 200 or 2. 'any' means match any caller number.
<b>Callee Prefix</b>	Set a prefix for called number. The prefix's length is less than or equal to called number, which helps to match the called number. If called number is 008675526456659, the called prefix can be 0086755 or 00. 'any' means match any called number.
<b>Calls to</b>	Determine the call is routed to a port, a port group, an IP trunk or a SIP server.
<b>Stripped Digits from Left</b>	The number of digits which are lessened from the left of the called number
<b>Stripped Digits from Right</b>	The number of digits which are lessened from the right of the called number

<b>from Right</b>	number
<b>Prefix to Add</b>	The prefix added to the called number after its digits are lessened.
<b>Suffix to Add</b>	The suffix added to the called number after its digits are lessened.

## 4.12 Management

### 4.12.1 TR069

TR069 is short for Technical Report 069, which provides a commonly-used framework and protocol for next-generation network devices. As an application-level protocol on top of IP TR069 has no limitation to access ways of network devices.

Under the network management model of TR069, ACS (Auto-Configuration Server) works as a management server, responsible for managing CPEs (Custom Premise Equipment).

ACS URL (auto-configuration server URL address) is provided by service provider. The ACS URL generally starts with http:// or https://

Username and password are used for ACS authentication.

Figure 4-30 Configure TR069 Parameter

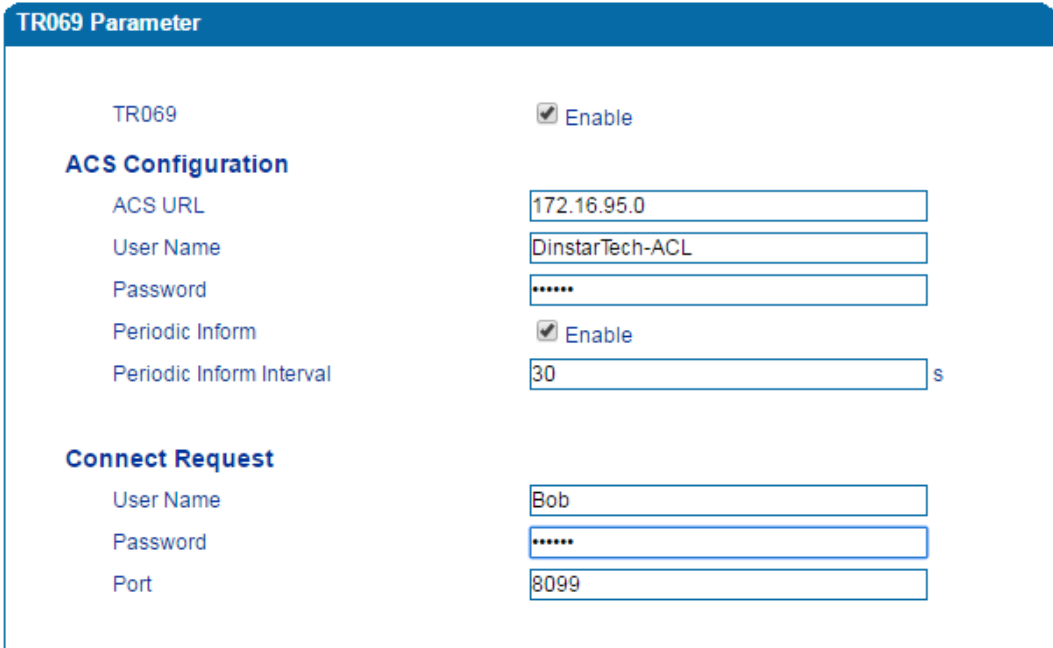

**TR069 Parameter**

TR069  Enable

**ACS Configuration**

ACS URL

User Name

Password

Periodic Inform  Enable

Periodic Inform Interval  s

**Connect Request**

User Name

Password

Port

Table 4-20 Explanation of TR069 Parameters

<b>TR069</b>	Choose whether to enable TR069; it is 'not enable' by default.
<b>ACS URL</b>	The IP address or domain name of ACS, which is provided by service provider.

<b>Username(ACS)</b>	Username of ACS, which is provided by service provider.
<b>Password(ACS)</b>	Password of ACS, which is provided by service provider.
<b>Periodic Inform</b>	Choose whether to enable 'Periodic Inform'; if it is enabled, ACS will connect to CPE every 30 seconds (if the interval is set as 30 seconds).
<b>Periodic Inform Interval</b>	The interval set for periodic connection between ACS and CPE.
<b>Username (CPE)</b>	Username of CPE
<b>Password (CPE)</b>	Password of CPE
<b>Port</b>	The port to connect CPE and ACS

## 4.12.2 SNMP

**SNMP (Simple Network Management Protocol)** is an Internet-standard protocol for collecting and organizing information about managed devices on IP networks and for modifying that information to change device behavior. Devices that typically support SNMP include routers, switches, servers, workstations, printers, modem racks and more.

SNMP is widely used in network management for network monitoring. SNMP exposes management data in the form of variables on the managed systems organized in a management information base which describe the system status and configuration. These variables can then be remotely queried (and, in some circumstances, manipulated) by managing applications.

Three significant versions of SNMP have been develop. SNMPv1 is the original version of the protocol. More recent versions, SNMPv2c and SNMPv3, feature improvements in performance, flexibility and security.

Figure 4-31 Configure SNMP Parameters

SNMP Parameter

**Snmp**  Enable

**Snmp Version** v1 ▼

**Community Configuration**

	Community	Source
1st	<input type="text"/>	<input type="text"/>
2nd	<input type="text"/>	<input type="text"/>
3rd	<input type="text"/>	<input type="text"/>

Note: Value of 'Source' is 'default' or IP Address(eg:192.168.1.1)!

**Group Configuration**

	Group	Community
1st	<input type="text"/>	<input style="border: 1px solid #ccc;" type="text"/>
2nd	<input type="text"/>	<input style="border: 1px solid #ccc;" type="text"/>
3rd	<input type="text"/>	<input style="border: 1px solid #ccc;" type="text"/>

**View Configuration**

	ViewName	ViewType	ViewSubtree	ViewMask
1st	<input type="text"/>	<input style="border: 1px solid #ccc;" type="text"/>	<input type="text"/>	<input type="text"/>
2nd	<input type="text"/>	<input style="border: 1px solid #ccc;" type="text"/>	<input type="text"/>	<input type="text"/>
3rd	<input type="text"/>	<input style="border: 1px solid #ccc;" type="text"/>	<input type="text"/>	<input type="text"/>

Note: Value style of 'ViewSubtree' is 'x.x.x.x'(multi-nodes) or '.x'(one node).

**Access Configuration(v1/v2c)**

	Group	Read	Write	Notify
1st	<input style="border: 1px solid #ccc;" type="text"/>	<input style="border: 1px solid #ccc;" type="text"/>	<input style="border: 1px solid #ccc;" type="text"/>	<input style="border: 1px solid #ccc;" type="text"/>
2nd	<input style="border: 1px solid #ccc;" type="text"/>	<input style="border: 1px solid #ccc;" type="text"/>	<input style="border: 1px solid #ccc;" type="text"/>	<input style="border: 1px solid #ccc;" type="text"/>
3rd	<input style="border: 1px solid #ccc;" type="text"/>	<input style="border: 1px solid #ccc;" type="text"/>	<input style="border: 1px solid #ccc;" type="text"/>	<input style="border: 1px solid #ccc;" type="text"/>

Note: The value of Read/Write/Notify references to 'ViewName' in View Configuration. Access Configuration is base on Group Configuration and View Configuration.

**Trap Configuration**

	Trap Type	Trap IP	Trap Port	Trap Community
1st	<input style="border: 1px solid #ccc;" type="text"/>	<input type="text"/>	0 <input type="text"/>	<input type="text"/>

Table 4-21 Explanation of SNMP Parameters

SNMP	The DAG2000 device supports three versions of SNMP, namely V1、V2C and V3.
------	---

<b>Community Configuration</b>	<p>Community configuration exists in V1 and V2C.</p> <p><b>Community:</b> fill in a community name used to read through SNMP protocol; it is a character string.</p> <p><b>Source:</b> The IP address of SNMP server.</p> <p>SNMP server cannot identify the packets sent from DAG2000 unless the community configured in DAG2000 matches with the community configured in SNMP server.</p>
<b>Group Configuration</b>	<p>Group configuration exists in V1 and V2C and V3.</p> <p><b>Group:</b> fill in a group name which is used to identify the group; it's a character string.</p> <p><b>Community:</b> fill in a community which means this community has joined in the group.</p> <p>In the following, access permission of read, write and notify is configured for each group.</p>
<b>View Configuration</b>	<p>View configuration exists in V1, V2C and V3.</p> <p><b>ViewName:</b> fill in a view name which is used to identify this view.</p> <p><b>ViewType:</b> choose 'Included' or 'Excluded'. 'Included' means the view includes the OID of the corresponding ViewSubtree, while 'Excluded' means the OID of the corresponding ViewSubtree is excluded from this view.</p> <p><b>ViewSubtree:</b> fill in the OID of the view subtree.</p> <p><b>ViewMask:</b> it is used to withdraw a row of a table, such as an Ethernet port.</p>
<b>Access Configuration</b>	<p>Access configuration exists in V1, V2C and V3, under which permission of read, write or notify is configured for a community group.</p> <p><b>Group:</b> choose a group name that has been configured.</p> <p><b>Read:</b> Choose a 'read' view for the group.</p> <p><b>Write:</b> Choose a 'write' view for the group.</p> <p><b>Notify:</b> Choose a 'notify' view for the group.</p>
<b>Trap Configuration</b>	<p>Trap configuration exists in V1, V2C and V3, which is aimed to send trap alarm.</p> <p><b>Trap Type:</b> Choose V1, V2C and Inform.</p> <p><b>Trap IP:</b> the IP address of the destination SNMP server where trap alarm is sent.</p> <p><b>Trap Port:</b> the port of the destination SNMP server, which will receive trap alarm.</p> <p><b>Trap Community:</b> the community configured in the destination SNMP server.</p>
<b>User Configuration</b>	<p>User configuration exists in V3. When V3 transmits SNMP packets in an encryption way, this item needs to be configured.</p> <p><b>User:</b> fill in a user name used to authenticate.</p> <p><b>AuthType:</b> choose MD5 or SHA as authentication type.</p>

	<p><b>AuthPassword:</b> the password used to authenticate.</p> <p><b>Privacy Type:</b> Choose DES, AES or AES 128 as encryption type.</p> <p><b>Privacy Password:</b> the encryption password.</p>
--	--

### 4.12.3 Syslog

Syslog is a standard for message logging. It allows separation of the software that generates messages, the system that stores messages, and the software that reports and analyzes messages. It also provides a means to notify administrators of problems or performance.

Syslog levels include: EMERG, ALERT, CRIT, ERROR, WARNING, NOTICE, INFO and DEBUG.

Figure 4-32 Configure Syslog Parameters

Syslog Parameter

<b>Local Syslog</b>	<input checked="" type="checkbox"/> Enable
Server Address	<input type="text" value="172.16.80.123"/>
Server Port	<input type="text" value="514"/>
Syslog Level	<input style="border: 1px solid #0070C0;" type="text" value="EMERG"/>
Signal Log	<input checked="" type="checkbox"/> Enable
Media Log	<input checked="" type="checkbox"/> Enable
System Log	<input checked="" type="checkbox"/> Enable
Management Log	<input checked="" type="checkbox"/> Enable
<b>Server Syslog</b>	<input type="checkbox"/> Enable

When the DAG2000 device registers to SIM Cloud server, local syslog will be changed to non-configurable and all logs will be stored on the Cloud server.

### 4.12.4 Provision

Provision is used to make the DAG2000 device automatically upgrade with the latest firmware stored on an http server, an ftp server or a tftp server. Please refer to the Instruction for Using Provision.

Figure 4-33 Provision

Table 4-22 Explanation of Provision Parameters

<b>URL</b>	URL of provisioning server, support HTTP, TFTP, FTP
<b>Check Interval</b>	The interval to check whether there is new firmware version on the provisioning server
<b>Account</b>	Account for logging in provisioning server
<b>Password</b>	Password for logging in provisioning server

## 4.12.5 Cloud server

You can register the DAG2000 device to cloud server, and then the device can be managed by the cloud server.

Figure 4-34 Configure Cloud Server

Table 4-23 Explanation of Parameters for Cloud Server

<b>Server Address</b>	The IP address of the cloud server
<b>Port</b>	The listening port of the cloud server
<b>Domain</b>	The domain name of the cloud server
<b>Join the remote management system</b>	Choose whether to join the remote management system of the cloud server.

## 4.12.6 User Manage

On the **Management** → **User Manage** page, the administrator of the DAG2000 device can classify users in different groups, and set login username and password for each user.

Figure 4-35 Modify Username and Password

## 4.12.7 Remote Server

In case that you need remote technical support, technical support engineers can connect your device with a service server on the **Management** → **Remote Server** page, so as to better help you to solve problems.

Figure 4-36 Configure Remote Server



## 4.12.8 Action URL

Action URL is a means of allowing VoIP platform/VoIP server to learn about the statuses of the DAG2000 device. This is realized by GET request over the HTTP protocol. During the transmission of status, some data (such as device ID, mac address, called/caller number, IP address) carried in GET request can also be reported to VoIP platform/VoIP server.

The data that can be carried in GET request, please refer to the notes on the **Management** → **Action URL** page.

Figure 4-37 Configure Action URL

Event	Action URI
Startup	<input type="text" value="http://host:port/file.php?macaddr=\$mac"/>
Offhook	<input type="text"/>
Onhook	<input type="text"/>
Incoming Call	<input type="text"/>
Outgoing Call	<input type="text"/>
Call Build	<input type="text"/>
Call Terminate	<input type="text"/>
Register Status	<input type="text"/>
Heartbeat	<input type="text"/>
Heartbeat Interval	<input type="text" value="10"/> s

**Event:** Statuses of DAG2000 device, which will be reported to VoIP platform/VoIP server.

**Action URL:** for example, [http://host:port/file.php?macaddr=\\$mac](http://host:port/file.php?macaddr=$mac), among which ‘host’ means the HTTP server’s IP address or domain name, ‘port’ means the http server’s listening port, ‘file.php’ means the script that will process this request, and ‘\$mac’ means the parameter carried in the request when this request is sent out.

**Heartbeat:** heartbeat packets are sent to URL by the DAG2000 device, used to examine the connection between the DAG2000 device and HTTP/HTTP server.

## 4.13 Security

### 4.13.1 WEB ACL

ACL (Access Control List) for Web is used to configure IP addresses that are allowed to access the Web Interface of the DAG2000 device. The IP address list can’t be null once ACL is enabled.

Figure 4-38 Add IP Address to Web ACL

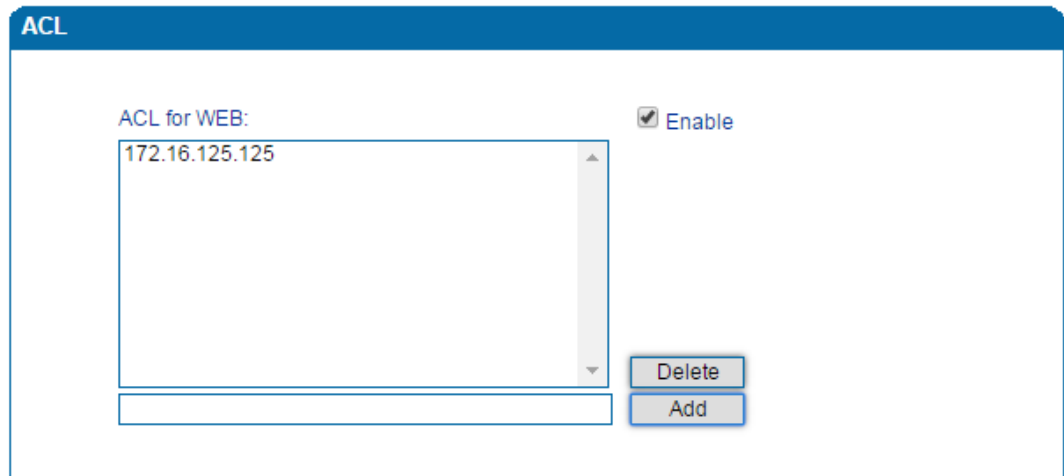

The screenshot shows a web interface titled "ACL" with a sub-section "ACL for WEB:". On the right, there is a checked checkbox labeled "Enable". Below this, a text input field contains the IP address "172.16.125.125". To the right of the input field are two buttons: "Delete" and "Add". Below the input field is an empty text box for adding a new IP address.

### 4.13.2 Telnet ACL

ACL (Access Control List) for Telnet is used to configure IP addresses that are allowed to access the Telnet Interface of the DAG2000 device. The IP address list can't be null once ACL is enabled.

Figure 4-39 Add IP Address to Telnet ACL

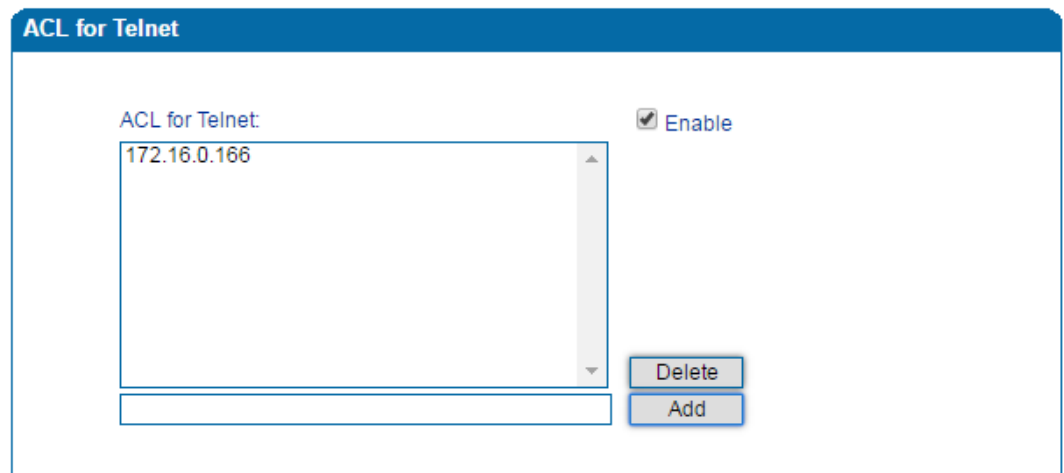

The screenshot shows a web interface titled "ACL for Telnet" with a sub-section "ACL for Telnet:". On the right, there is a checked checkbox labeled "Enable". Below this, a text input field contains the IP address "172.16.0.166". To the right of the input field are two buttons: "Delete" and "Add". Below the input field is an empty text box for adding a new IP address.

### 4.13.3 Passwords

You can configure or modify the username and password for logging in the Web interface and the Telnet interface of the DAG2000 device on this page.

**Note:** Both the username and password of Web and Telnet are 'admin' and 'admin' by default. It is advised to modify them for security consideration.

Figure 4-40 Modify Username and Password

Password Modification	
<b>Web Config</b>	
Old Web Username	<input type="text" value="admin"/>
Old Web Password	<input type="text"/>
New Web Username	<input type="text"/>
New Web Password	<input type="text"/>
Confirm Web Password	<input type="text"/>
<b>Telnet Config</b>	
Old Telnet Username	<input type="text" value="admin"/>
Old Telnet Password	<input type="text"/>
New Telnet Username	<input type="text"/>
New Telnet Password	<input type="text"/>
Confirm Telnet Password	<input type="text"/>

## 4.13.4 Encrypt

When the DAG2000 device is registered to a VOS softswitch, you can encrypt SIP and RTP for the VOS softswitch.

Figure 4-41 Encrypt SIP and RTP

Encryption Configuration	
SIP Encrypt	<input type="text" value="Enable"/>
RTP Encrypt	<input type="text" value="RTP"/>
Encrypt Mode	<input type="text" value="VOS RC4"/>

**Note:** If SIP encryption is enabled, heartbeat and anonymous calls should be disabled.

## 4.14 Tools

### 4.14.1 Firmware Upload

On the **Tools** → **Firmware** Upload page, you can upload a new firmware version from a local folder.

Figure 4-42 Upload Firmware

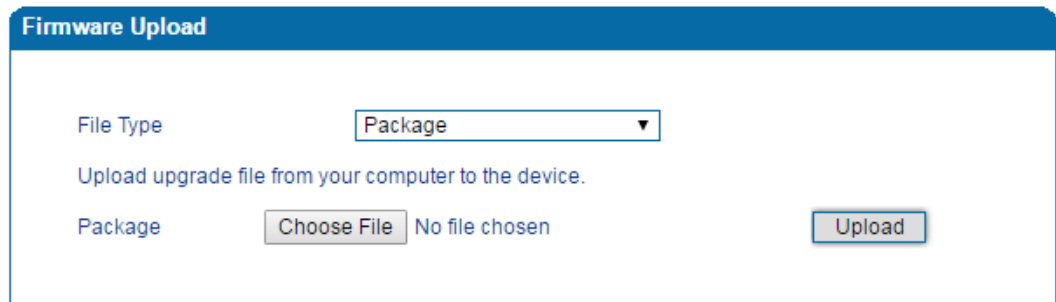

**Firmware Upload**

File Type

Upload upgrade file from your computer to the device.

Package  No file chosen

Steps of Firmware Uploading:

Step 1. Check the current firmware version on the **Status & Statistics → System Information** page.

Step 2. Prepare firmware package.

Step 3. Upload firmware, select the package from a specific folder on the computer and click the **Upload** button.

Step 4. Keep waiting until it prompts 'Software loaded successfully!'

Step 5. Reboot the device on the **Tools → Device Restart** page.

## 4.14.2 Data Backup

On the **Tools → Data Backup** page, you can download and backup configuration data, device status and summary messages on local computer.

Figure 4-43 Backup Data

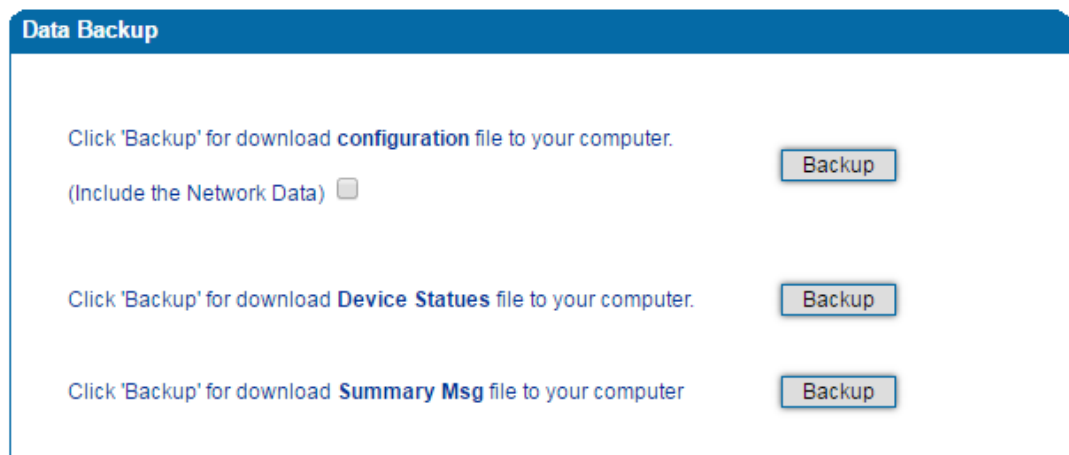

**Data Backup**

Click 'Backup' for download **configuration** file to your computer.

(Include the Network Data)

Click 'Backup' for download **Device Statuses** file to your computer.

Click 'Backup' for download **Summary Msg** file to your computer.

### 4.14.3 Data Restore

On the **Tools** → **Data Restore** page, you can restore configuration data through uploading a data file from local computer. The restored configurations will take effect after the device is restarted.

Figure 4-44 Restore Data

### 4.14.4 Ping Test

**Ping** is used to examine whether a network works normally through sending test packets and calculating response time.

Instructions for using Ping:

1. Enter the IP address or domain name of a network, a website or a device in the input box of Ping, and then click **Start**.
2. If related messages are received, it means the network works normally; otherwise, the network is not connected or is connected faultily.

Figure 4-45 Execute Ping Test

## 4.14.5 Tracert Test

Tracert is short for traceroute, used to track a route from one IP address to another.

Instruction for using Traceroute:

1. Enter the IP address or domain name of a destination device in the input box of Traceroute, and then click **Start**.

Figure 4-46 Execute Tracert Test

The screenshot shows a web interface for a Tracert test. It features a blue header with the text 'Tracert Test'. Below the header, there are two input fields. The first is labeled 'Destination' and contains the IP address '172.16.95.35'. The second is labeled 'Max Hops(1-255)' and contains the number '30'. At the bottom of the form, there are two buttons: 'Start' and 'Stop'.

**Destination:** the IP address or domain name of a destination device that needs to be tracked.

**Max Hops:** the maximum hops for searching the above IP address or domain name. For example, if 'max hops' is set as 30, and the configured IP address or domain name cannot be reached within 30 hops, it's thought that the IP address or domain name cannot be searched.

2. View the route information from the returned message.

## 4.14.6 Outward Test

Outward test enables you to diagnose the physical function of FXS port which follow the GR909 standard. To start outward test, select the FXS ports to be tested and click 'Start'. The testing may cost a few minutes.

Figure 4-47 Execute Outward Test

The screenshot shows a web interface for an Outward Test. It features a blue header with the text 'Outward Test'. Below the header is a table with the following columns: Port, Enable, Loop Open, H.F. DC Voltage(V), H.F. AC Voltage(mV), Tip/Ring Short, and Result. The table contains two rows of data for ports 0 and 1. Below the table, there is an 'Options' section with a checkbox labeled 'Test All Ports'.

Port	Enable	Loop Open	H.F. DC Voltage(V)	H.F. AC Voltage(mV)	Tip/Ring Short	Result
0	<input checked="" type="checkbox"/>	NO	0	0	NO	OK
1	<input checked="" type="checkbox"/>	NO	0	0	NO	OK

Options:  
 Test All Ports

### Test Results:

OK: the physical function of the tested FXS ports is working well;

FAIL: There's something wrong with the physical function of the tested FXS ports.

## 4.14.7 Network Capture

Network capture is an important diagnostics tool for maintenance. It is used to capture data packages of the available network ports.

### PCM Capture:

PCM capture helps to analysis voice stream between analog phone and DSP chipset.

Figure 4-48 Capture PCM Packages

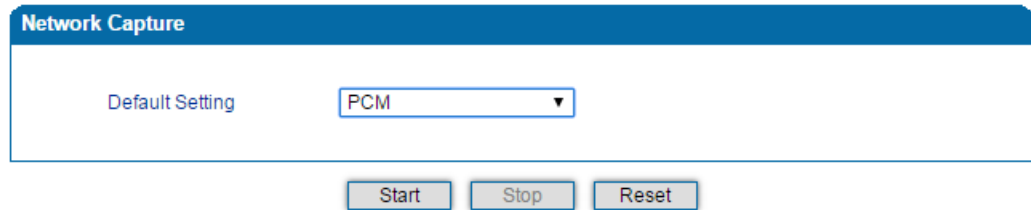

- ◆ Click “Start” to enable PCM capture
- ◆ Dialing out through the device, start talking a short while then hang up the call.
- ◆ Click ‘Stop’ to disable network capture
- ◆ Save the file to local computer

The captured package is named ‘capture(x).pcap’, among which x is the serial number of the capturing and will be added 1 in next time. The sample of PCM capture as below:

No.	Time	Source	Destination	Protocol	Length	Info	
1	0.000000	Motorola_1c:1d:1e	Cimsys_33:44:55	CSM_ENCABS	104	--> 0x0021	Ch: 0xFFFF, Seq: 8 (From Host)
2	0.000131	Cimsys_33:44:55	Motorola_1c:1d:1e	Ethernet	20	--> 0x0021	20 Ethernet II[Malformed Packet]
3	0.000245	Cimsys_33:44:55	Motorola_1c:1d:1e	CSM_ENCABS	44	--> 0x0021	Ch: 0xFFFF, Seq: 11 (From Host)
4	1.320893	Motorola_1c:1d:1e	Cimsys_33:44:55	CSM_ENCABS	104	--> 0x0e00	Ch: 0x0003, Seq: 0 (From Host)
5	1.321022	Cimsys_33:44:55	Motorola_1c:1d:1e	Ethernet	20	--> 0x0e00	20 Ethernet II[Malformed Packet]
6	1.321129	Cimsys_33:44:55	Motorola_1c:1d:1e	CSM_ENCABS	30	--> 0x0e00	Ch: 0x0003, Seq: 1 (From Host)
7	1.329890	Motorola_1c:1d:1e	Cimsys_33:44:55	CSM_ENCABS	104	--> 0x0e01	Ch: 0x0003, Seq: 1 (From Host)
8	1.330010	Cimsys_33:44:55	Motorola_1c:1d:1e	Ethernet	20	--> 0x0e01	20 Ethernet II[Malformed Packet]
9	1.330093	Cimsys_33:44:55	Motorola_1c:1d:1e	CSM_ENCABS	30	--> 0x0e01	Ch: 0x0003, Seq: 2 (From Host)
10	1.330472	Motorola_1c:1d:1e	Cimsys_33:44:55	CSM_ENCABS	104	--> 0x0802	Ch: 0x0003, Seq: 1 (From Host)
11	1.330566	Cimsys_33:44:55	Motorola_1c:1d:1e	Ethernet	20	--> 0x0802	20 Ethernet II[Malformed Packet]
12	1.330639	Cimsys_33:44:55	Motorola_1c:1d:1e	CSM_ENCABS	30	--> 0x0802	Ch: 0x0003, Seq: 3 (From Host)
13	1.330820	Motorola_1c:1d:1e	Cimsys_33:44:55	CSM_ENCABS	104	--> 0x0803	Ch: 0x0003, Seq: 3 (From Host)
14	1.330903	Cimsys_33:44:55	Motorola_1c:1d:1e	Ethernet	20	--> 0x0803	20 Ethernet II[Malformed Packet]
15	1.330989	Cimsys_33:44:55	Motorola_1c:1d:1e	CSM_ENCABS	30	--> 0x0803	Ch: 0x0003, Seq: 4 (From Host)
16	1.337791	Motorola_1c:1d:1e	Cimsys_33:44:55	CSM_ENCABS	104	--> 0x9010	Ch: 0x0003, Seq: 4 (From Host)
17	1.337996	Cimsys_33:44:55	Motorola_1c:1d:1e	Ethernet	20	--> 0x9010	20 Ethernet II[Malformed Packet]
18	1.338033	Cimsys_33:44:55	Motorola_1c:1d:1e	CSM_ENCABS	30	--> 0x9010	Ch: 0x0003, Seq: 5 (To Host)
19	1.338369	Motorola_1c:1d:1e	Cimsys_33:44:55	CSM_ENCABS	104	--> 0x9000	Ch: 0x0003, Seq: 5 (From Host)
20	1.338460	Cimsys_33:44:55	Motorola_1c:1d:1e	Ethernet	20	--> 0x9000	20 Ethernet II[Malformed Packet]
21	1.343564	Cimsys_33:44:55	Motorola_1c:1d:1e	CSM_ENCABS	30	--> 0x9000	Ch: 0x0003, Seq: 6 (To Host)
22	1.343521	Motorola_1c:1d:1e	Cimsys_33:44:55	CSM_ENCABS	104	--> 0x8084	Ch: 0x0003, Seq: 6 (From Host)
23	1.343627	Cimsys_33:44:55	Motorola_1c:1d:1e	Ethernet	20	--> 0x8084	20 Ethernet II[Malformed Packet]
24	1.343725	Cimsys_33:44:55	Motorola_1c:1d:1e	CSM_ENCABS	30	--> 0x8084	Ch: 0x0003, Seq: 7 (To Host)
25	1.344060	Motorola_1c:1d:1e	Cimsys_33:44:55	CSM_ENCABS	104	--> 0x8001	Ch: 0x0003, Seq: 7 (From Host)

### Syslog Capture:

Syslog capture is another way to obtain syslog which is the same as remote syslog server and filelog. The captured file is save as pcap format so that it can be opened in some of capturing software like Wireshark, Ethereal software etc.

Figure 4-49 Capture Syslog Packages

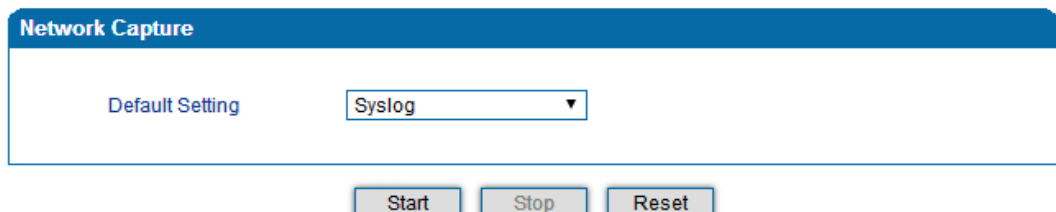

- ◆ Click ‘Start’ to enable syslog capture
- ◆ Dialing out through the device, start talking a short while then hang up the call.
- ◆ Click ‘Stop’ to disable syslog capture
- ◆ Save the capture to local computer

The capture package is named ‘capture(x).pcap’, among which x is the serial number of capturing and will be added 1 in next time. The sample of syslog capture as below:

No.	Time	Source	Destination	Protocol	Length	Info
1	0.000000	172.16.222.22	1.1.1.1	Syslog	172	USER, DEBUG: Jul 23 06:52:05 172.16.222.22 mpe_sip: < 0> [ DEBUG] ---->> to 172.16.222.22/5060 crypt:FALSE Phone
2	0.000344	172.16.222.22	1.1.1.1	Syslog	520	USER, DEBUG: Jul 23 06:52:05 172.16.222.22 mpe_sip: < 1> [ DEBUG] OPTIONS sip:heartbeat@172.16.222.22 SIP/2.0\r\n
3	0.013432	172.16.222.22	1.1.1.1	Syslog	595	USER, DEBUG: Jul 23 06:52:05 172.16.222.22 mpe_sip: < 2> [ DEBUG] <<---- message from 172.16.222.22/5060, crypt
4	0.013750	172.16.222.22	1.1.1.1	Syslog	176	USER, DEBUG: Jul 23 06:52:05 172.16.222.22 mpe_sip: < 3> [ DEBUG] <<---- from 172.16.222.22/5060, crypt:FALSE, Phc
5	0.014036	172.16.222.22	1.1.1.1	Syslog	520	USER, DEBUG: Jul 23 06:52:05 172.16.222.22 mpe_sip: < 4> [ DEBUG] OPTIONS sip:heartbeat@172.16.222.22 SIP/2.0\r\n
6	0.014512	172.16.222.22	1.1.1.1	Syslog	172	USER, DEBUG: Jul 23 06:52:05 172.16.222.22 mpe_sip: < 5> [ DEBUG] ---->> to 172.16.222.22/5060 crypt:FALSE Phone
7	0.014806	172.16.222.22	1.1.1.1	Syslog	587	USER, DEBUG: Jul 23 06:52:05 172.16.222.22 mpe_sip: < 6> [ DEBUG] SIP/2.0 200 OK\r\nVia: SIP/2.0/UDP 172.16.222.
8	0.028396	172.16.222.22	1.1.1.1	Syslog	662	USER, DEBUG: Jul 23 06:52:05 172.16.222.22 mpe_sip: < 7> [ DEBUG] <<---- message from 172.16.222.22/5060, crypt
9	0.028759	172.16.222.22	1.1.1.1	Syslog	176	USER, DEBUG: Jul 23 06:52:05 172.16.222.22 mpe_sip: < 8> [ DEBUG] <<---- from 172.16.222.22/5060, crypt:FALSE, Phc
10	0.029052	172.16.222.22	1.1.1.1	Syslog	587	USER, DEBUG: Jul 23 06:52:05 172.16.222.22 mpe_sip: < 9> [ DEBUG] SIP/2.0 200 OK\r\nVia: SIP/2.0/UDP 172.16.222.
11	0.030017	172.16.222.22	1.1.1.1	Syslog	233	USER, DEBUG: Jul 23 06:52:05 172.16.222.22 mpe_sip: < 10> [ DEBUG] sip-->app: msgtype:ST_SIP_SERVER_CONN \r\n cal
12	0.331167	172.16.222.22	1.1.1.1	Syslog	983	USER, DEBUG: Jul 23 06:52:05 172.16.222.22 mpe_sip: < 11> [ DEBUG] <<---- message from 172.16.222.127/5060, cryp
13	0.331498	172.16.222.22	1.1.1.1	Syslog	177	USER, DEBUG: Jul 23 06:52:05 172.16.222.22 mpe_sip: < 12> [ DEBUG] <<---- from 172.16.222.127/5060, crypt:FALSE, PF
14	0.331959	172.16.222.22	1.1.1.1	Syslog	907	USER, DEBUG: Jul 23 06:52:05 172.16.222.22 mpe_sip: < 13> [ DEBUG] INVITE sip:100868172.16.222.22:5060 SIP/2.0\r\n
15	0.332307	172.16.222.22	1.1.1.1	Syslog	122	USER, DEBUG: Jul 23 06:52:05 172.16.222.22 mpe_sip: < 14> [ DEBUG] get route entry 31\r\n
16	0.332584	172.16.222.22	1.1.1.1	Syslog	111	USER, DEBUG: Jul 23 06:52:05 172.16.222.22 mpe_sip: < 15> [ DEBUG] !port:3\r\n
17	0.332848	172.16.222.22	1.1.1.1	Syslog	124	USER, DEBUG: Jul 23 06:52:05 172.16.222.22 mpe_sip: < 16> [ DEBUG] get route, to port:3\r\n
18	0.333315	172.16.222.22	1.1.1.1	Syslog	526	USER, DEBUG: Jul 23 06:52:05 172.16.222.22 mpe_sip: < 17> [ DEBUG] sip-->app: localindex:69, msgtype:SIP_CALL_IN
19	0.333803	172.16.222.22	1.1.1.1	Syslog	173	USER, DEBUG: Jul 23 06:52:05 172.16.222.22 mpe_sip: < 18> [ DEBUG] ---->> to 172.16.222.127/5060 crypt:FALSE Phone
20	0.333877	172.16.222.22	1.1.1.1	Syslog	386	USER, DEBUG: Jul 23 06:52:05 172.16.222.22 mpe_sip: < 19> [ DEBUG] SIP/2.0 100 Trying\r\nVia: SIP/2.0/UDP 172.16.
21	0.346687	172.16.222.22	1.1.1.1	Syslog	131	USER, DEBUG: Jul 23 06:52:05 172.16.222.22 mpe_sip: < 20> [ DEBUG] RTP: alg:0, pkt:20, band:-1\r\n
22	0.347453	172.16.222.22	1.1.1.1	Syslog	120	USER, DEBUG: Jul 23 06:52:05 172.16.222.22 mpe_sip: < 21> [ DEBUG] dial tick:102433\r\n
23	7.232839	172.16.222.22	1.1.1.1	Syslog	533	USER, DEBUG: Jul 23 06:52:12 172.16.222.22 mpe_sip: < 22> [ DEBUG] <<---- message from 172.16.222.127/5060, cryp
24	7.233513	172.16.222.22	1.1.1.1	Syslog	177	USER, DEBUG: Jul 23 06:52:12 172.16.222.22 mpe_sip: < 23> [ DEBUG] <<---- from 172.16.222.127/5060, crypt:FALSE, PH
25	7.233959	172.16.222.22	1.1.1.1	Syslog	457	USER, DEBUG: Jul 23 06:52:12 172.16.222.22 mpe_sip: < 24> [ DEBUG] CANCEL sip:100868172.16.222.22:5060 SIP/2.0\r\n
26	7.234596	172.16.222.22	1.1.1.1	Syslog	287	USER, DEBUG: Jul 23 06:52:12 172.16.222.22 mpe_sip: < 25> [ DEBUG] sip-->app: localindex:69, msgtype:SIP_CALL_BYE

### DSP Capture:

DSP capture helps to analyze voice stream inside DSP chipset. The DSP chipset will handle RTP from IP network as well as voice stream from analog phone.

Figure 4-50 Capture DSP Packages

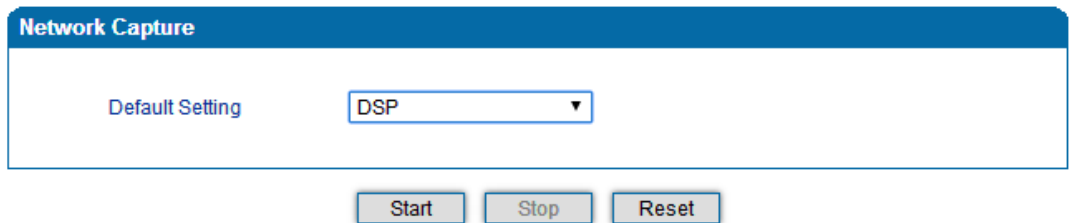

- ◆ Click Start to enable DSP capture
- ◆ Dialing out through the device, start talking a short while then hang up the call.
- ◆ Click Stop to disable DSP capture
- ◆ Save the capture to local computer

The captured package is named ‘capture(x).pcap’, among which x is the serial number of RTP capturing and will be added 1 in next time. The sample of RTP capture as below:

No.	Time	Source	Destination	Protocol	Length	Info
1	0.000000	Motorola_ic:1d:1e	Cmsys_33:44:55	CSM_ENCAPS	104	--> 0x0021 Ch: 0xFFFF, Seq: 2 (From Host)
2	0.007246	Cmsys_33:44:55	Motorola_ic:1d:1e	Ethernet	20	Ethernet II[Malformed Packet] Ch: 0xFFFF, Seq: 3 (From Host)
3	0.007260	Cmsys_33:44:55	Motorola_ic:1d:1e	CSM_ENCAPS	44	--> 0x0021 Ch: 0xFFFF, Seq: 5 (From Host)
4	2.984581	Motorola_ic:1d:1e	Cmsys_33:44:55	CSM_ENCAPS	104	--> 0x0021 Ch: 0xFFFF, Seq: 6 (From Host)
5	2.997308	Cmsys_33:44:55	Motorola_ic:1d:1e	Ethernet	20	Ethernet II[Malformed Packet] Ch: 0xFFFF, Seq: 4 (From Host)
6	2.997316	Cmsys_33:44:55	Motorola_ic:1d:1e	CSM_ENCAPS	44	--> 0x0021 Ch: 0xFFFF, Seq: 7 (From Host)
7	5.997290	Motorola_ic:1d:1e	Cmsys_33:44:55	CSM_ENCAPS	104	--> 0x0021 Ch: 0xFFFF, Seq: 8 (From Host)
8	5.997282	Cmsys_33:44:55	Motorola_ic:1d:1e	Ethernet	20	Ethernet II[Malformed Packet] Ch: 0x0003, Seq: 3 (From Host)
9	5.997290	Cmsys_33:44:55	Motorola_ic:1d:1e	CSM_ENCAPS	44	--> 0x0021 Ch: 0x0003, Seq: 1 (To Host)
10	7.691428	Motorola_ic:1d:1e	Cmsys_33:44:55	CSM_ENCAPS	104	--> 0x0010 Ch: 0x0003, Seq: 3 (From Host)
11	7.691552	Cmsys_33:44:55	Motorola_ic:1d:1e	Ethernet	20	Ethernet II[Malformed Packet] Ch: 0x0003, Seq: 1 (To Host)
12	7.691715	Cmsys_33:44:55	Motorola_ic:1d:1e	CSM_ENCAPS	30	--> 0x0010 Ch: 0x0003, Seq: 4 (From Host)
13	7.701379	Motorola_ic:1d:1e	Cmsys_33:44:55	CSM_ENCAPS	104	--> 0x0000 Ch: 0x0003, Seq: 2 (To Host)
14	7.701494	Cmsys_33:44:55	Motorola_ic:1d:1e	Ethernet	20	Ethernet II[Malformed Packet] Ch: 0x0003, Seq: 5 (From Host)
15	7.701622	Cmsys_33:44:55	Motorola_ic:1d:1e	CSM_ENCAPS	30	--> 0x0000 Ch: 0x0003, Seq: 3 (To Host)
16	7.709662	Motorola_ic:1d:1e	Cmsys_33:44:55	CSM_ENCAPS	104	--> 0x8084 Ch: 0x0003, Seq: 6 (From Host)
17	7.709798	Cmsys_33:44:55	Motorola_ic:1d:1e	Ethernet	20	Ethernet II[Malformed Packet] Ch: 0x0003, Seq: 4 (To Host)
18	7.709902	Cmsys_33:44:55	Motorola_ic:1d:1e	CSM_ENCAPS	30	--> 0x8084 Ch: 0x0003, Seq: 5 (From Host)
19	7.710238	Motorola_ic:1d:1e	Cmsys_33:44:55	CSM_ENCAPS	104	--> 0x8001 Ch: 0x0003, Seq: 6 (From Host)
20	7.710328	Cmsys_33:44:55	Motorola_ic:1d:1e	Ethernet	20	Ethernet II[Malformed Packet] Ch: 0x0003, Seq: 4 (To Host)
21	7.710496	Cmsys_33:44:55	Motorola_ic:1d:1e	CSM_ENCAPS	30	--> 0x8001 Ch: 0x0003, Seq: 7 (From Host)
22	7.716241	Motorola_ic:1d:1e	Cmsys_33:44:55	CSM_ENCAPS	104	--> 0x8018 Ch: 0x0003, Seq: 5 (To Host)
23	7.716352	Cmsys_33:44:55	Motorola_ic:1d:1e	Ethernet	20	Ethernet II[Malformed Packet] Ch: 0x0003, Seq: 8 (From Host)
24	7.716465	Cmsys_33:44:55	Motorola_ic:1d:1e	CSM_ENCAPS	30	--> 0x8018 Ch: 0x0003, Seq: 5 (To Host)
25	7.716711	Motorola_ic:1d:1e	Cmsys_33:44:55	CSM_ENCAPS	104	--> 0x805b Ch: 0x0003, Seq: 8 (From Host)



### Customized Capture:

This menu provides more options to capture specific packages according to actually needs.

Figure 4-51 Customized Capturing

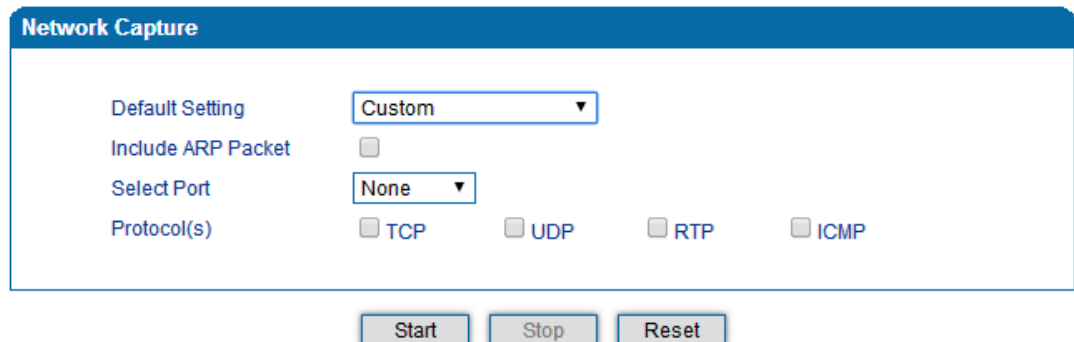

The screenshot shows the 'Network Capture' configuration panel. It includes a 'Default Setting' dropdown menu set to 'Custom', an 'Include ARP Packet' checkbox which is unchecked, a 'Select Port' dropdown menu set to 'None', and a 'Protocol(s)' section with four checkboxes: 'TCP', 'UDP', 'RTP', and 'ICMP', all of which are unchecked. Below the configuration options are three buttons: 'Start', 'Stop', and 'Reset'.

### 4.14.8 Factory Reset

Click 'Apply' to restore configurations of the device to the factory default settings.

Figure 4-52 Reset Device to Factory Default Setting

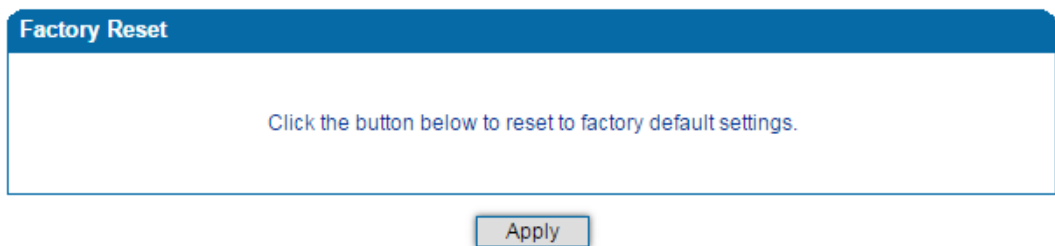

The screenshot shows the 'Factory Reset' configuration panel. It contains a single instruction: 'Click the button below to reset to factory default settings.' Below this instruction is a single button labeled 'Apply'.

### 4.14.9 Device Restart

For some configurations or changes to the DAG2000 device, you are required to restart the device for the configurations or changes to take effect.

Figure 4-53 Restart Device

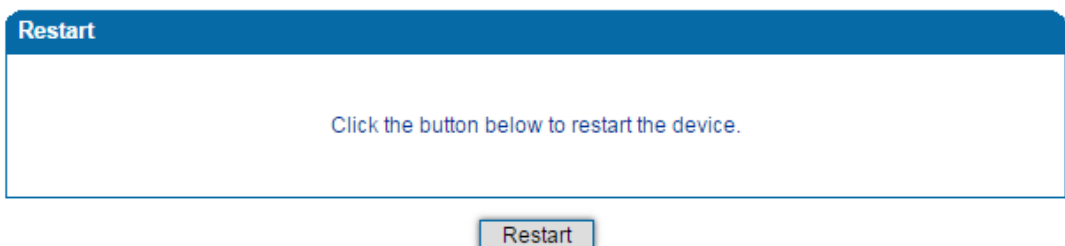

The screenshot shows the 'Restart' configuration panel. It contains a single instruction: 'Click the button below to restart the device.' Below this instruction is a single button labeled 'Restart'.

# 5 Glossary

<b>Abbr.</b>	<b>Full Name</b>
ARP	Address Resolution Protocol
CID	Caller Identity
DNS	Domain Name System
DND	Do NOT Disturb
DTMF	DTMF: Dual Tone Multi Frequency
DHCP	Dynamic Host Configuration Protocol
DMZ	Demilitarized Zone
DDNS	Dynamic Domain Name Server
DSP	Digital Signal Process
NTP	Network Time Protocol
PPPOE	Point-to-point Protocol over Ethernet
PSTN	Public Switched Telephone Network
PCM	Pulse Code Modulation
QoS	Quality of Service
VLAN	Virtual Local Area Network
SIP	Session Initiation Protocol
STUN	Simple Traversal of UDP over NAT
SNMP	Simple Network Management Protocol
RTP	Real Time Protocol
UDP	User Datagram Protocol