

# NDS3508B-24 Tuner to IP Gateway

## User's Manual



# DIRECTORY

- CHAPTER 1 PRODUCT OUTLINE..... 1**
- 1.1 Outline..... 1
- 1.2 Features ..... 1
- 1.3 Inner Principle ..... 2
- 1.4 Specifications ..... 2
- 1.5 Appearance and Description ..... 3
  
- CHAPTER 2 INSTALLATION GUIDE ..... 5**
- 2.1 Acquisition Check ..... 5
- 2.2 Installation Preparation ..... 5
- 2.3 Wire’s Connection ..... 7
  
- CHAPTER 3 WEB NMS OPERATION ..... 8**
- 3.1 login..... 8
- 3.2 Operation ..... 8
  
- CHAPTER 4 TROUBLESHOOTING ..... 17**
  
- CHAPTER 5 PACKING LIST ..... 18**

# Chapter 1 Product Outline

## 1.1 Outline

NDS3508B-24 Tuner to IP Gateway is a head-end interface conversion device which supports MPTS and SPTS output switchable. It supports 24 MPTS+2 MPTS ( ASI and USB port ) or 1024 SPTS output over UDP and RTP/RTSP protocol. It is integrated with tuner demodulation (or ASI input) and gateway function, which can demodulate the signal from 24 tuners into IP package, or directly convert the TS from ASI input and tuner into IP package, then output the IP package through different IP address and ports. BISS function is also embedded for tuner input to descramble your tuner input programs.

## 1.2 Features

- Support 24 FTA DVB- S/S2/S2X input, 1 ASI input, 1USB input
- Support BISS descrambling
- Support DisEqc function
- 24 MPTS or 1024 SPTS output (MPTS and SPTS output switchable)
- 2 GE output (IP address and port number of GE1 and GE2 are different), up to 850Mbps---SPTS
- 2 independent GE output port, GE1(512 SPTS) + GE2(512 SPTS)---MPTS(total 26)
- Support PID filtering, re-mapping (Only for SPTS output)
- Support “Null PKT Filter” function (Only for MPTS output)
- Support Web operation

### 1.3 Inner Principle

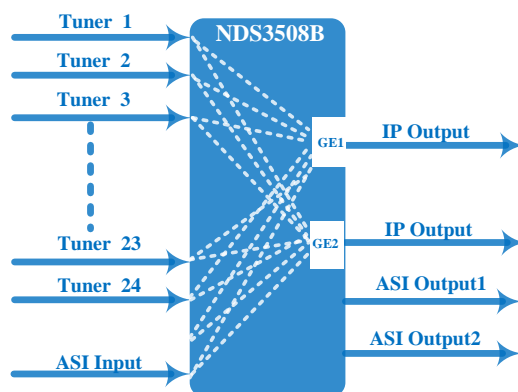

### 1.4 Specifications

<b>Input</b>	24 tuners input +1 ASI input+1 USB Port---SPTS/MPTS output		
<b>Tuner Section</b>	DVB-S	Frequency In	950-2150MHz
		Symbol rate	0.5~45Msps
		Signal Strength	- 65- -25dBm
		FEC	1/2, 2/3, 3/4, 5/6, 7/8
		Constellation	QPSK
		Max input bitrate	≤125 Mbps
	DVB-S2	Frequency In	950-2150MHz
		Symbol rate	QPSK/8PSK /16APSK :0.5~45 Msps 32APSK: 0.5~34Msps;
		FEC	QPSK: 1/2, 3/5, 2/3, 3/4, 4/5, 5/6, 8/9, 9/10 8PSK: 3/5, 2/3, 3/4, 5/6, 8/9, 9/10 16APSK: 2/3, 3/4, 4/5, 5/6, 8/9, 9/10 32APSK: 3/4, 4/5, 5/6, 8/9, 9/10
		Constellation	QPSK, 8PSK, 16APSK, 32APSK
		Max input bitrate	≤125 Mbps
		DVB-S2X	Frequency In
	Symbol rate		QPSK/8PSK /16APSK :0.5~45 Msps 8APSK: 0.5~40Msps 32APSK: 0.5~34Msps
	FEC		QPSK: 1/2, 3/5, 2/3, 3/4, 4/5, 5/6, 8/9, 9/10, 13/45, 9/20, 11/20 8PSK: 3/5, 2/3, 3/4, 5/6, 8/9, 9/10 8APSK: 5/9-L, 26/45-L 16APSK: 2/3, 3/4, 4/5, 5/6, 8/9, 9/10, 1/2-L, 8/15-L, 5/9-L, 26/45, 3/5, 3/5-L, 28/45, 23/36, 2/3-L, 25/36, 13/18, 7/9, 77/90 32APSK: 3/4, 4/5, 5/6, 8/9, 9/10, 2/3-L, 32/45, 11/15, 7/9

	Constellation	QPSK, 8PSK, 8APSK, 16APSK, 32APSK
	Max input bitrate	≤125 Mbps
<b>BISS Descrambling</b>	Mode 1, Mode E (Up to 850Mbps) (descramble individual program)	
<b>Output</b>	1024 SPTS IP output over UDP and RTP/RTSP protocol through GE1 and GE2 port (IP address and port number of GE1 and GE2 are different) , Unicast and Multicast	
	26 MPTS IP output (for Tuner/ASI/USB pass-through) over UDP and RTP/RTSP protocol through GE1 and GE2 port, Unicast and Multicast , 2 ASI output	
<b>System</b>	Web based management	
	Ethernet software upgrade	
<b>Miscellaneous</b>	Dimension	482mm×410mm×44mm (W×L×H)
	Approx weight	3.6kg
	Environment	0~45°C(work); -20~80°C (Storage)
	Power requirements	100~240VAC, 50/60Hz
	Power consumption	20W

## 1.5 Appearance and Description

Front Panel Illustration:



1	ASI input port
2	ASI output port
3	Data port (GE1&GE2) : IP out port
4	NMS port: Network management interface
5	USB port
6	Power indicator

## Rear Panel Illustration

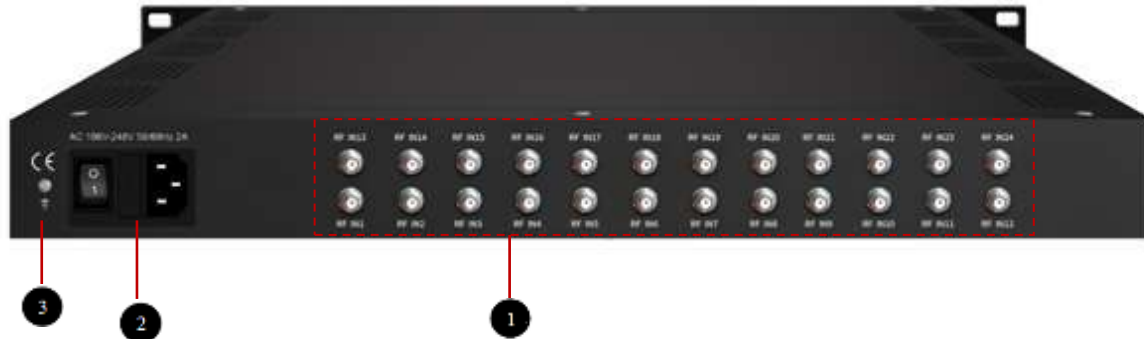

1	24 channels RF IN Interface
2	Integrated power switch and socket
3	Grounding Wire

## Chapter 2 Installation Guide

### 2.1 Acquisition Check

When users open the package of the device, it is necessary to check items according to packing list. Normally it should include the following items:

- NDS3508B-24 Tuner to IP Gateway
- Grounding Cable
- RF In and Loop Out Cable
- Power Cord

If any item is missing or mismatching with the list above, please contact local dealer.

### 2.2 Installation Preparation

When users install device, please follow the below steps. The details of installation will be described at the rest part of this chapter. Users can also refer rear panel chart during the installation.

The main content of this chapter including:

- Checking the possible device missing or damage during the transportation
- Preparing relevant environment for installation
- Installing gateway
- Connecting signal cables
- Connecting communication port (if it is necessary)

#### 2.2.1 Device's Installation Flow Chart Illustrated as following:

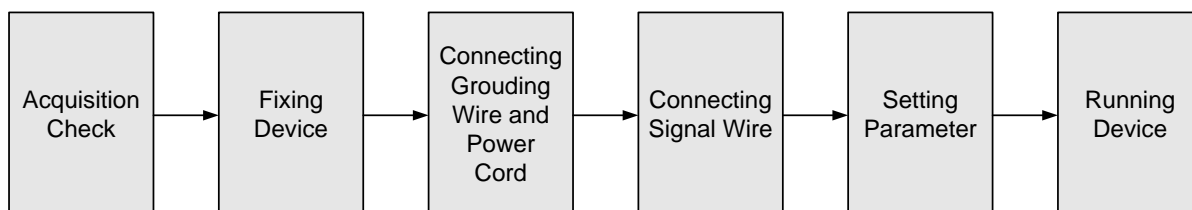

#### 2.2.2 Environment Requirement

Item	Requirement
Machine Hall Space	When user installs machine frame array in one machine hall, the distance between 2 rows of machine frames should be 1.2~1.5m and the distance against wall should be no less than 0.8m.
Machine Hall Floor	Electric Isolation, Dust Free Volume resistivity of ground anti-static material: $1 \times 10^7 \sim 1 \times 10^{10} \Omega$ , Grounding current limiting resistance: 1M (Floor bearing should be greater than $450 \text{Kg/m}^2$ )
Environment Temperature	5~40°C(sustainable ), 0~45°C(short time), installing air-conditioning is recommended
Relative Temperature	20%~80% sustainable 10%~90% short time
Pressure	86~105KPa
Door & Window	Installing rubber strip for sealing door-gaps and dual level glasses for window
Wall	It can be covered with wallpaper, or brightness less paint.
Fire Protection	Fire alarm system and extinguisher
Power	Requiring device power, air-conditioning power and lighting power are independent to each other. Device power requires AC power 100V-240V 50/60Hz 2A. Please carefully check before running.

### 2.2.3 Grounding Requirement

- All function modules' good grounding designs are the basis of reliability and stability of devices. Also, they are the most important guarantee of lightning arresting and interference rejection. Therefore, the system must follow this rule.
- Coaxial cable's outer conductor and isolation layer should keep proper electric conducting with the metal housing of device.
- Grounding conductor must adopt copper conductor in order to reduce high frequency impedance, and the grounding wire must be as thick and short as possible.
- Users should make sure the 2 ends of grounding wire well electric conducted and be



antirust.

- It is prohibited to use any other device as part of grounding electric circuit
- The area of the conduction between grounding wire and device's frame should be no less than 25mm<sup>2</sup>.

### **2.2.4 Frame Grounding**

All the machine frames should be connected with protective copper strip. The grounding wire should be as short as possible and avoid circling. The area of the conduction between grounding wire and grounding strip should be no less than 25mm<sup>2</sup>.

### **2.2.5 Device Grounding**

Connecting the device's grounding rod to frame's grounding pole with copper wire.

## **2.3 Wire's Connection**

The grounding wire conductive screw is located at the right end of rear panel, and the power switch, fuse, power supply socket is just beside ,whose order goes like this, power switch is on the left ,power supply socket is on the right and the fuse is just between them.

- **Connecting Power Cord**

User can insert one end into power supply socket, while insert the other end to AC power.

- **Connecting Grounding Wire**

When the device solely connects to protective ground, it should adopt independent way, say, share the same ground with other devices. When the device adopts united way, the grounding resistance should be smaller than 1Ω.

---

**⚠ Caution:**

**Before connecting power cord to NDS3508B Tuner to IP Gateway, user should set the power switch to "OFF".**

---

## Chapter 3 WEB NMS operation

User can only control and set the configuration in computer by connecting the device to web NMS Port. User should ensure that the computer's IP address is different from the NDS3508B's IP address; otherwise, it would cause IP conflict.

### 3.1 login

The default IP of this device is 192.168.0.136.

Connect the PC and the device with net cable, and use ping command to confirm they are on the same network segment.

I.G. the PC IP address is 192.168.99.252, we then change the device IP to 192.168.99.xxx (xxx can be 0 to 255 except 252 to avoid IP conflict).

Use web browser to connect the device with PC by inputting this device's IP address in the browser's address bar and press Enter.

It displays the Login interface as Figure-1. Input the Username and Password (Both the default Username and Password are "admin".) and then click "Login" to start the device setting.

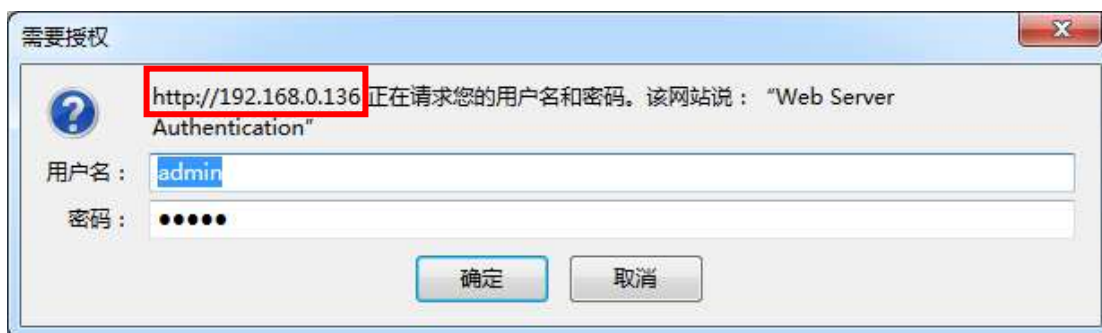

Figure-1

### 3.2 Operation

#### Summary → Status

When we confirm the login, it displays the status interface as Figure-2

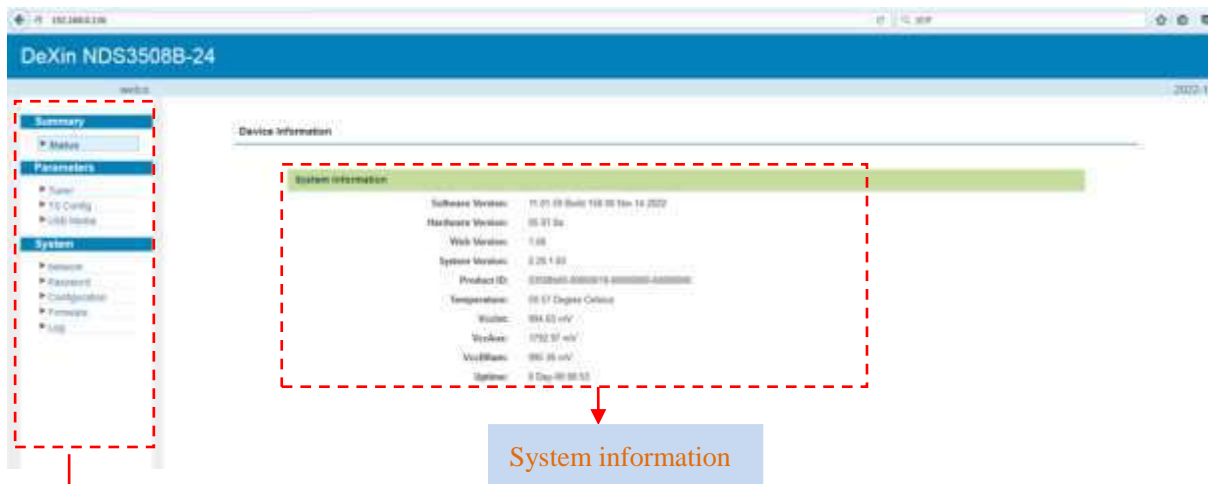

Figure-2

User can click any item here to enter the corresponding interface to check information or set the parameters.

**Parameter → Tuner input (DVB-S2/S2X)**

From the menu on top side of the webpage, click “Tuner”, it displays the interface where users can check the 24 DVB-S/S2/S2X Tuners input status. (Figure-3)

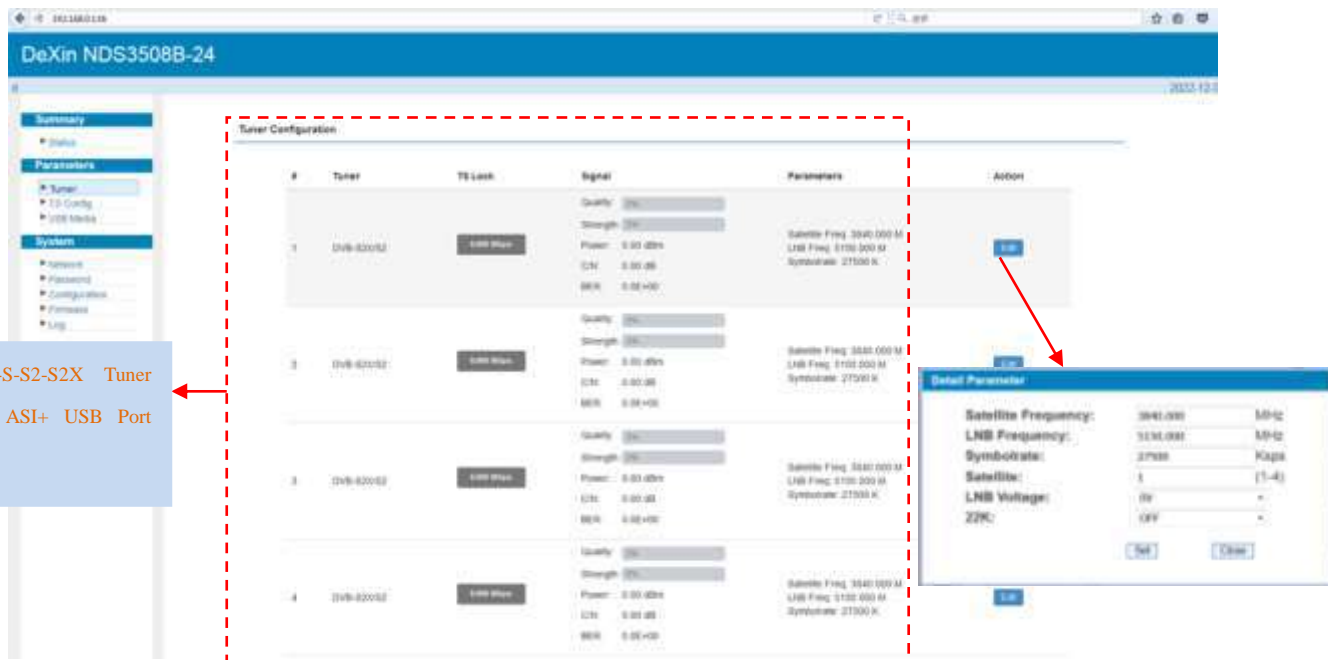

Figure-3

**Parameter → TS config**

From the menu on top side of the webpage, click “TS config”, it displays the interface where users can check the 24 tuner+1 ASI+USB Port parse status. (Figure-4)

➤ **TS Config→DATA 1/ DATA 2:**

Clicking “DATA 1/DATA2”, it displays the interface where users can select the data1 or data2 for program(s) output (Figure-4).

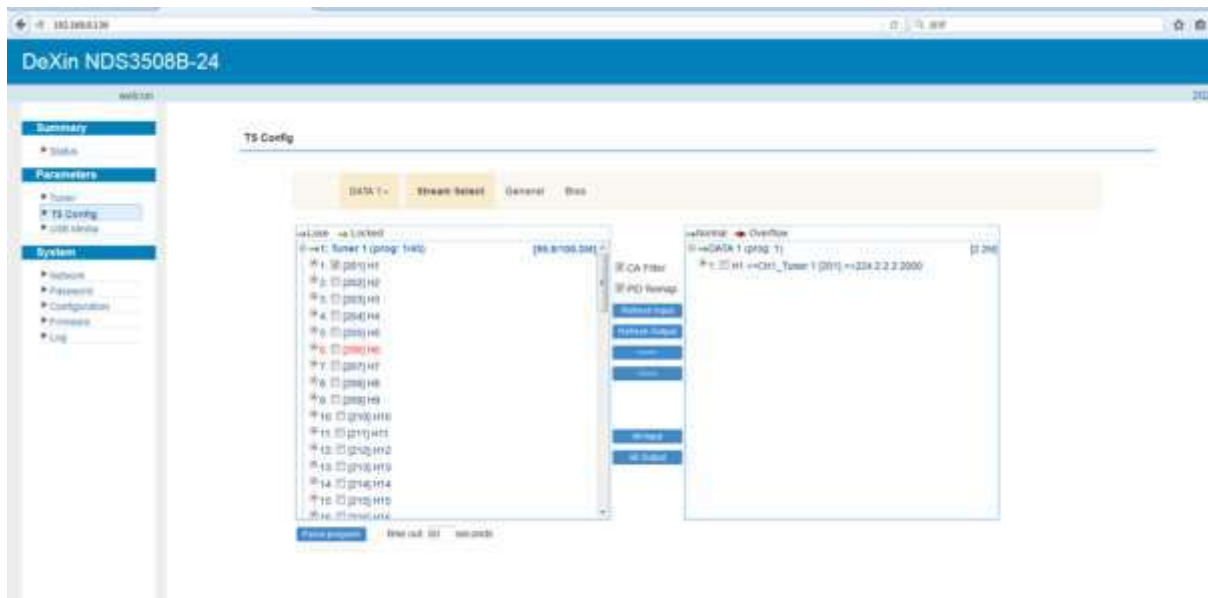

Figure-4

➤ **TS Config→Stream select:**

Clicking “Stream select”, it displays the interface where users can select program(s) to multiplex out and modify program info. (Figure-5)

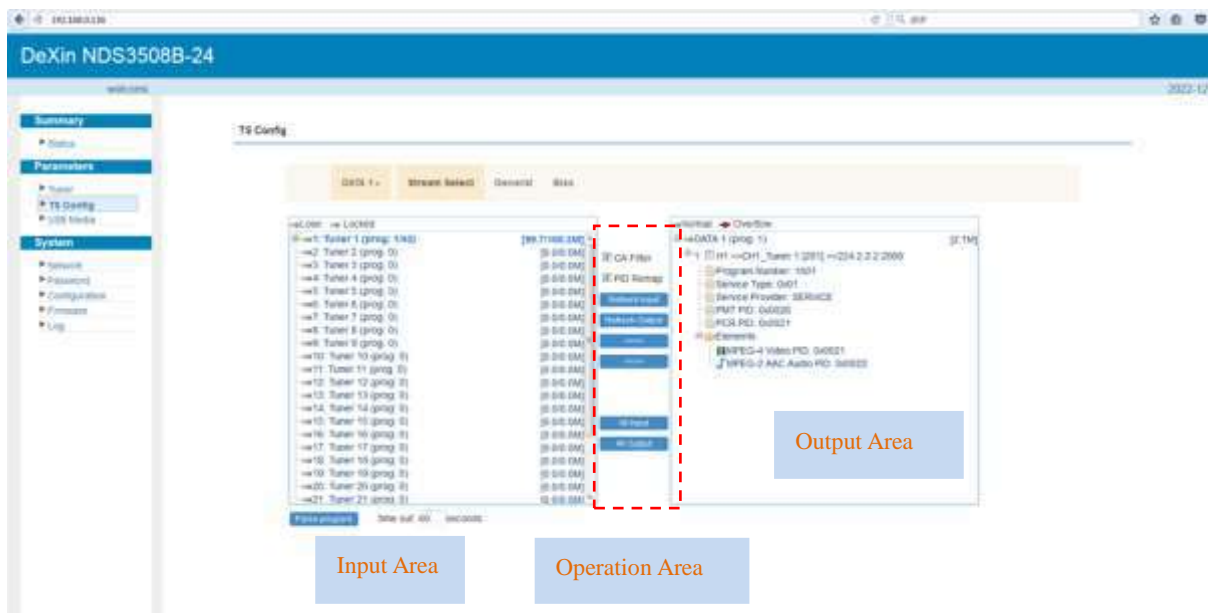

Figure-5

Configure 'Input Area' and 'Output Area' with buttons in 'Operation Area'. Instructions are as below:

**CA Filter** : To filter/not filter the source CA information

**PID Remap** : To enable/disable the PID remapping

**Refresh Input** To refresh the input program information

**Refresh Output** To refresh the output program information

**→** Select one input program first and click this button to transfer the selected program to the right box to output.

**←** Similarly, user can cancel the multiplexed programs from the right box.

**All Input** To select all the input programs

**All Output** To select all the output programs

**Parse program** To parse programs  seconds time limitation of parsing input programs

### ➤ **Program Modification:**

The multiplexed program information can be modified by clicking the program in the 'output' area. For example, when clicking **1: H1 <-CH1\_Tuner 1 [201]**, it triggers a dialog box (Figure 6) where users can input new information.



Figure 6

Note: NDS3508B support 16 Tuner input and 2 ASI input with 512 SPTS output, the parameter interface is different from MPTS. When users switch SPTS to MPTS, new mode will work after reboot the device.

➤ **TS Config→General:**

From the TS Config menu on up side of the webpage, clicking “General”, it displays the interface where users can choose different character encoding. (Figure-6)

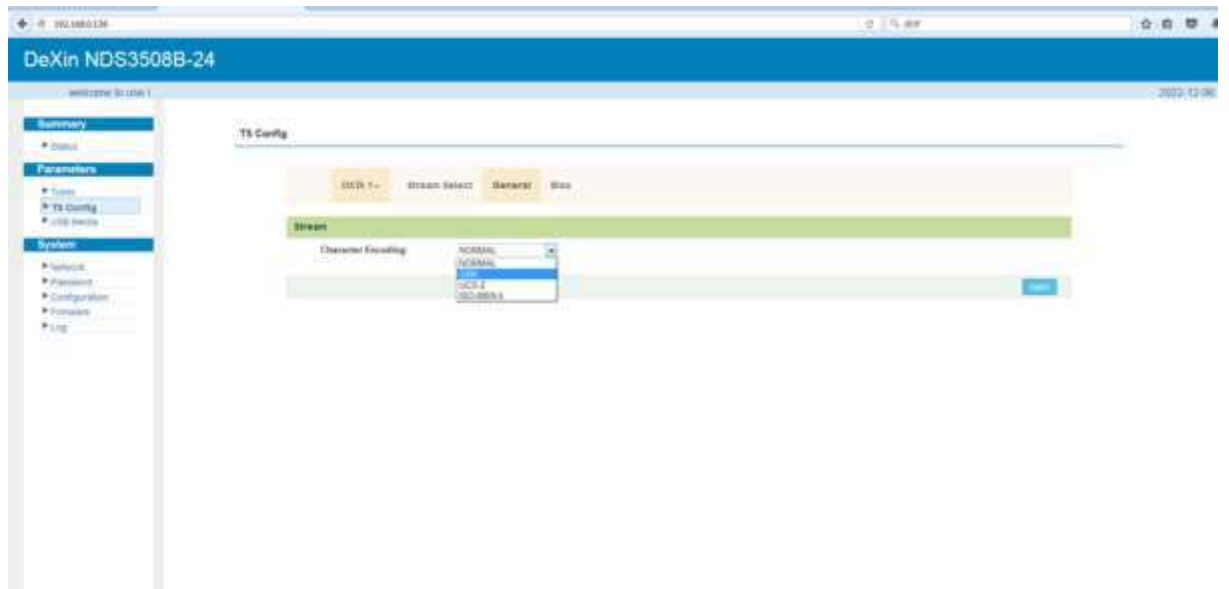

Figure-6

➤ **TS Config→BISS:**

From the menu on left side of the webpage, clicking “BISS”, it displays the interface where users can configure BISS and descramble the input channels (Figure-7).

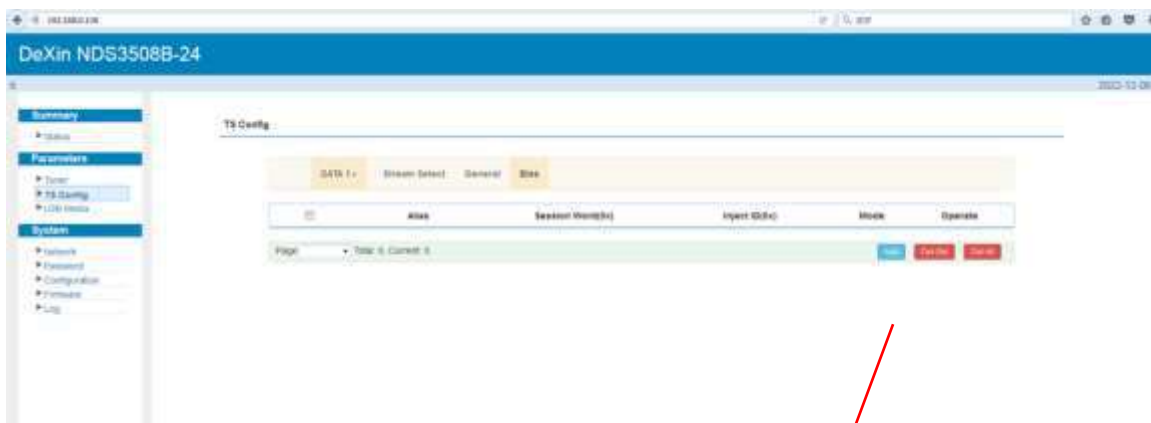

Figure-7

Users can set BISS parameter through click ”Add” button.



**Parameter → USB media:**

Under USB Media page, user can play the TS files from the USB disk. Play Mode is select-able as the below list shows. After playing the files, the programs in the .ts files can be multiplexed out in TS Config page (Figure-8).

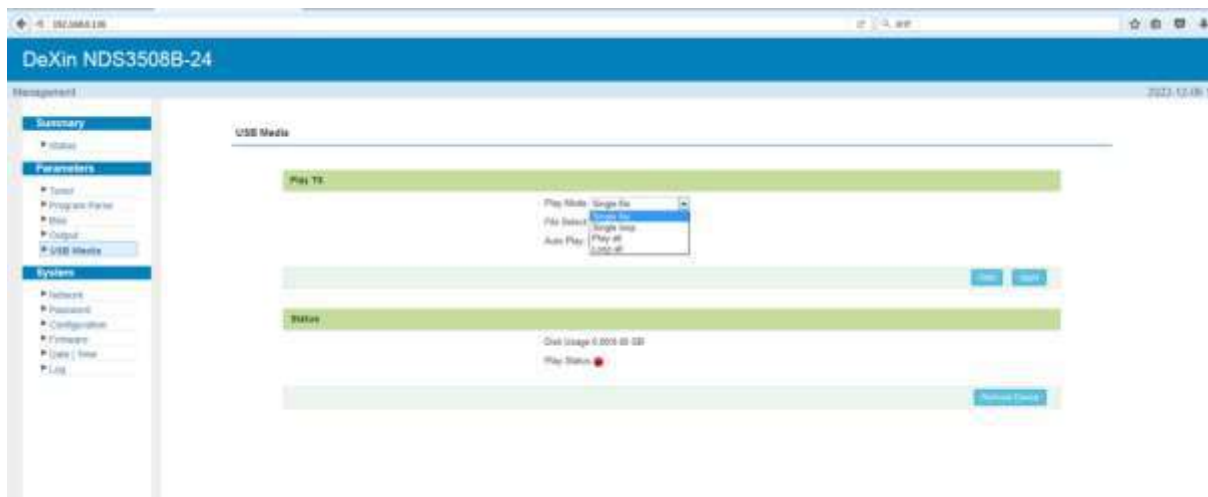

Figure-8

**Detailed Explanation:**

**Play Mode:** User can select a play mode for the \*.ts files as needed before playing the \*.ts file and specify a video under ‘Single file’ / ‘Single loop’ mode and press “Apply” and “Start” button to start play. While under ‘Play all’ / ‘Loop all’ mode, it automatically plays files from first to end. Loop means that it will play the selected files round.

**Auto Play:** If ticked, the device will automatically play the .ts files as per the saved setting after reboot.

The .ts files can also be generated by our TS Creator software. If needed, users can contact our technician to get the software.

**System → Network:**

Clicking “Network”, it displays the interface as Figure-9 where to set network parameters.

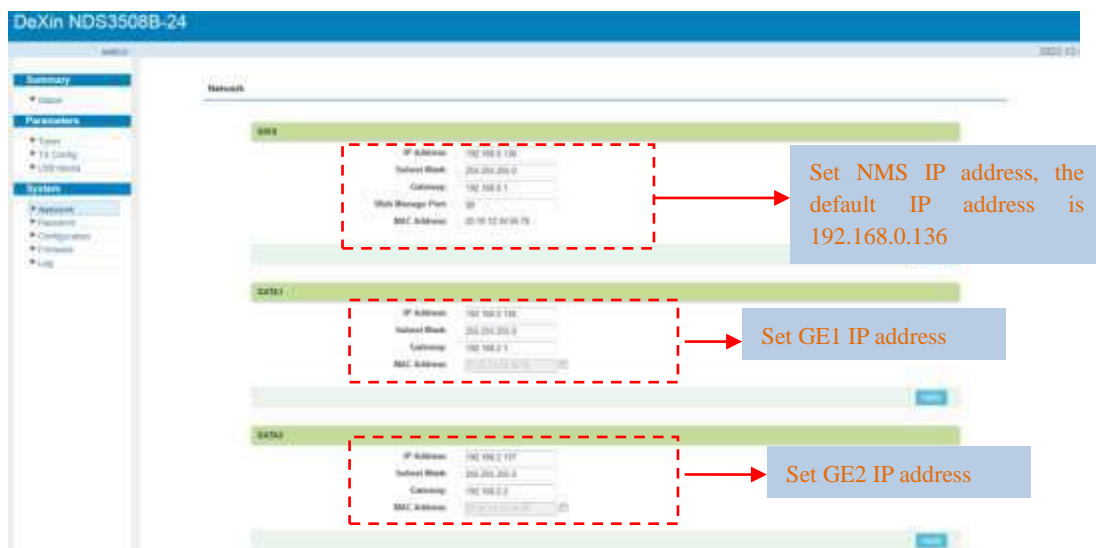

Figure-9

**System → Password:**

From the menu on left side of the webpage, clicking “Password”, it displays the screen as Figure-11 where to set the login account and password for the web NMS.

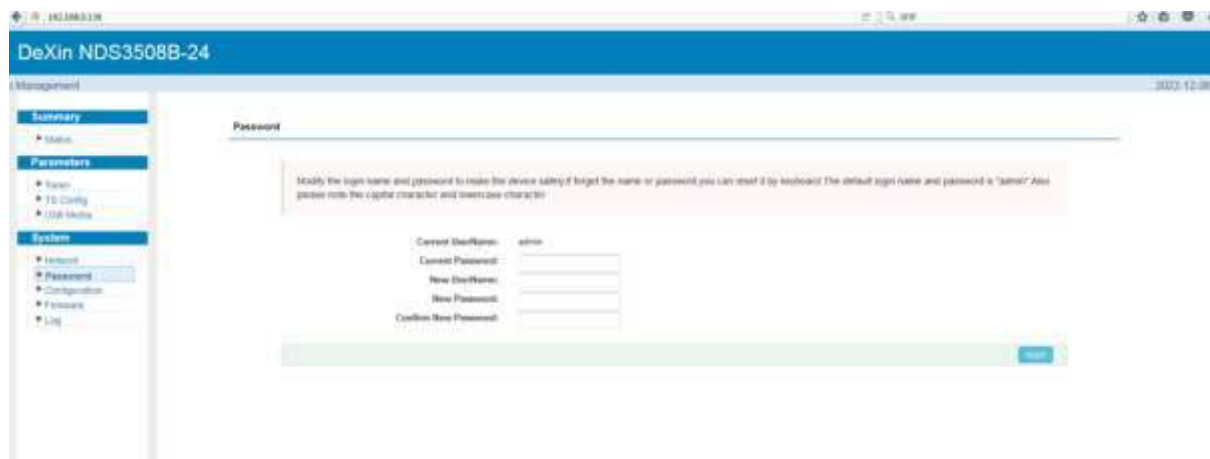

Figure-11

**System → Configuration:**

From the menu on left side of the webpage, clicking “Configuration”, it displays the screen as Figure-12 where to save /restore/Factory Set/Backup/Load your configurations.



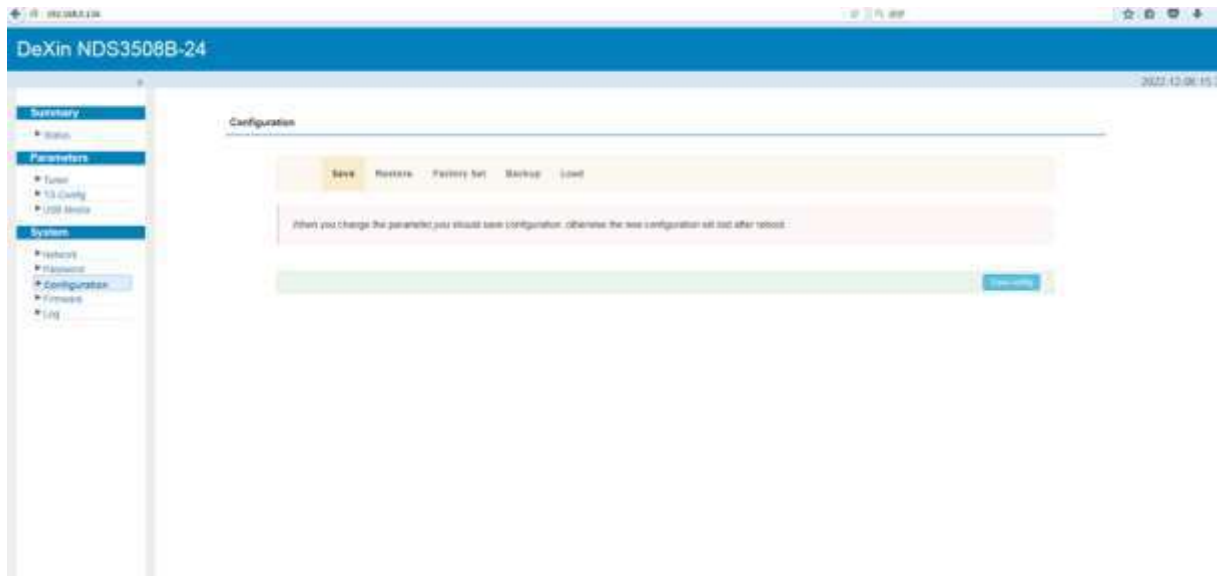

Figure-12

**System → Firmware:**

From the menu on left side of the webpage, clicking “Firmware”, it displays the screen as Figure-13 where to update firmware for the device.

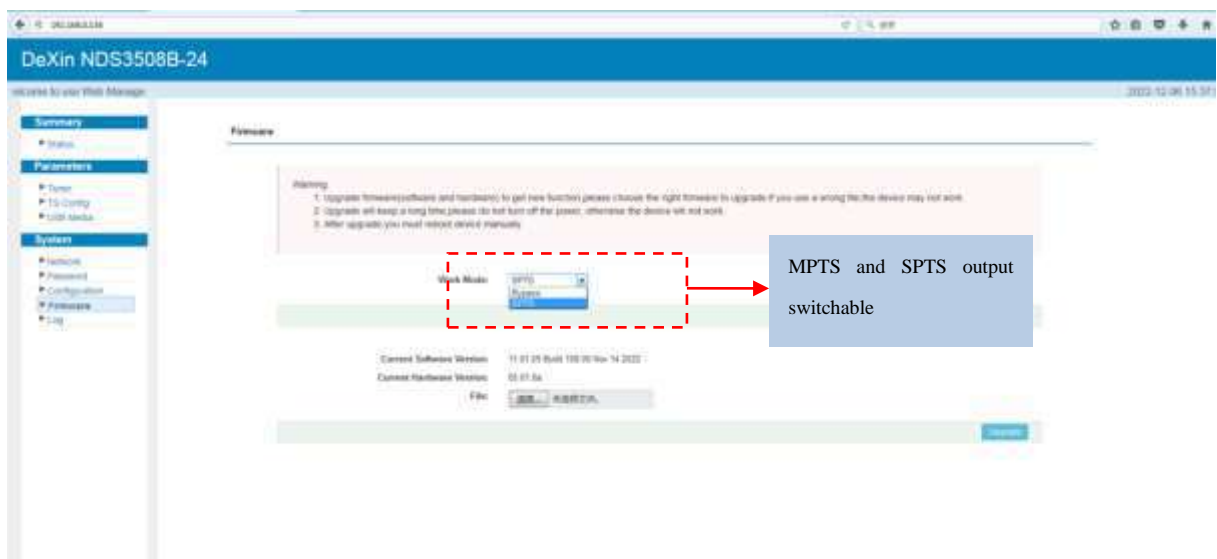

Figure-13

**System → Log:**

From the menu on left side of the webpage, clicking “Log”, it displays the screen as Figure-14 where to log information for the device.

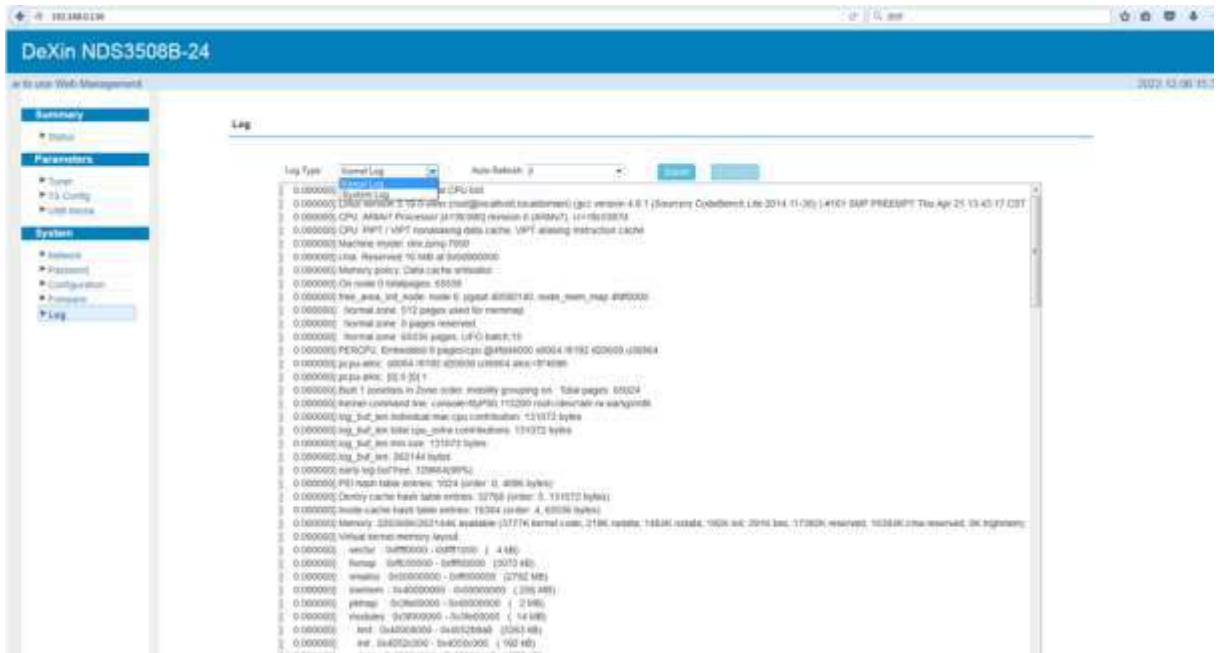

Figure-15

## Chapter 4 Troubleshooting

DEXIN's ISO9001 quality assurance system has been approved by CQC organization. For guarantee the products' quality, reliability and stability. All DEXIN products have been passed the testing and inspection before ship out factory. The testing and inspection scheme already covers all the Optical, Electronic and Mechanical criteria which have been published by DEXIN. To prevent potential hazard, please strictly follow the operation conditions.

### Prevention Measure

- Installing the device at the place in which environment temperature between 0 to 45 °C
- Making sure good ventilation for the heat-sink on the rear panel and other heat-sink bores if necessary
- Checking the input AC within the power supply working range and the connection is correct before switching on device
- Checking the RF output level varies within tolerant range if it is necessary
- Checking all signal cables have been properly connected
- Frequently switching on/off device is prohibited; the interval between every switching on/off must greater than 10 seconds.

### Conditions need to unplug power cord

- Power cord or socket damaged.
- Any liquid flowed into device.
- Any stuff causes circuit short
- Device in damp environment
- Device was suffered from physical damage
- Longtime idle.
- After switching on and restoring to factory setting, device still cannot work properly.
- Maintenance needed

## Chapter 5 Packing list

- NDS3508B-24 Tuner to IP gateway
- Grounding cable
- RF In and Loop Out Cable
- Power cord