

# Solar Hybrid Inverter

## User Manual



### Product Models

HES4855S100-H

## Important Safety Instructions

### **Please keep this Manual for future reference**

This Manual contains all the safety, installation and operation instructions of HES series PV energy-storage hybrid inverter.

Please read all instructions and precautions in this Manual carefully before installation and use.

- The inverters have internal unsafe voltage, in order to avoid personal injury, users should not disassemble them by themselves; if maintenance was required, should contact our professional maintenance personnel.
- Keep the inverter out of the reach of children.
- Do Not install the inverter in any flammable and explosive environment.
- The mains input and AC output are high voltage, so please Do Not touch the wire connector.
- When the inverter is working, the shell temperature will be very high, so please Do Not touch it.
- Please Do Not open the terminal protective cover when the inverter is working.
- It is recommended to install suitable fuse or circuit breaker outside the inverter.
- Before installing and adjusting the wiring of the Inverter, be sure to disconnect the fuse or circuit breaker near the PV array, the mains supply and the battery terminal.
- Check whether all wire connections are tight after installation to avoid danger of heat accumulation caused by virtual connection.
- The Inverter is off-grid type, for the input power of load equipment, it is required to confirm that this Inverter is the only input equipment and it is forbidden to use it in parallel with any other input AC power source so as to avoid damage.

# CONTENTS

<b>1. General information .....</b>	<b>4</b>
1.1 Product overview and features.....	4
1.2 Introduction to the Basic System .....	5
1.3 Product Features .....	6
1.4 Dimensional Diagram.....	7
<b>2. Installation Instructions .....</b>	<b>8</b>
2.1 Precautions for Installation .....	8
2.2 Wiring Specification and Circuit Breaker Selection .....	8
2.3 Installation and Wiring.....	10
<b>3. Working mode.....</b>	<b>16</b>
3.1 Charging Mode.....	16
3.2 Output Mode.....	17
<b>4. LCD Screen Operating Instructions.....</b>	<b>18</b>
4.1 Operation and Display Panel.....	18
4.2 Introduction to Operation Keys.....	18
4.3 Introduction to Indicator Light .....	18
4.4 Introduction to LCD Screen.....	19
4.5 Description of Setting Parameters.....	22
4.6 Battery Type Parameter List .....	27
<b>5. Other Functions.....</b>	<b>29</b>
5.1 Dry contact Function .....	29
5.2 RS485 Communication Function.....	29
5.3 USB Communication Function.....	29
5.4 CAN Communication Interface .....	29
<b>6. Protection.....</b>	<b>30</b>
6.1 Protection Functions Available .....	30
6.2 Meaning of Fault Code .....	31
6.3 Partial Troubleshooting Measures .....	32
<b>7. System Maintenance .....</b>	<b>33</b>
<b>8. Technical Parameters .....</b>	<b>34</b>

# 1. General information

## 1.1 Product overview and features

HES series is a new type of solar hybrid inverter, integrating solar energy storage and mains charging and AC sine-wave output. It is controlled by DSP and has the features of high response speed, high reliability and high industrial standard through state-of-art control algorithm. It has four charging modes: solar only, mains priority, solar power priority and solar hybrid; two output modes of inverter and Mains Power can be selected to meet different application requirements.

The solar charging module adopts the latest optimized MPPT technology, which can quickly track the MPP of PV array in any environment, obtain the maximum energy of solar panel in real time, and has a wide MPPT voltage range.

AC-DC charging module adopts state-of-art control algorithm for full digital double closed-loop control of voltage and current, which has high control precision and small size. Wide AC voltage input range, complete I/O protection functions, stable and reliable realization of battery charging and protection.

The DC-AC inverter module is based on all-digital intelligent design, adopting state-of-art SPWM technology, outputting pure sine wave, converting DC to AC, and thus suitable for AC loads such as household appliances, electric tools, industrial equipment, electronic audio and video, etc. The product adopts sectional LCD display design, which displays the running data and running status of the system in real time. The comprehensive electronic protection function can ensure that the entire system be safer and more stable.

### Characteristics:

1. Sectional charging and discharging function available, able to enable and disable AC charging function based on the charging section time be set, switch power supply mode between inverter and AC bypass based on the discharge section time be set.
2. Anti-counter-current grid-connected function (PV and mains hybrid power supply).
3. It has insulation impedance and leakage current detection function.
4. Support for use under battery-free conditions.
5. It has double activation function of lithium battery, which can be triggered by connecting any mains/PV power.
6. With the function of ECO mode and reducing no-load loss.
7. There are 4 charging modes available: solar only, Mains Power first, solar first and hybrid charging.
8. It has two output modes: Mains Power bypass and inverter output, and has the function of uninterrupted power supply.
9. It has multiple protection functions for 360° omni-directional protection.
10. Support lead-acid battery and lithium battery access.
11. The ON/OFF switch controls the inverter AC output.
12. PV Grid-connected power generation mode can be set.
13. Adopt full digital voltage and current double closed-loop control, state-of-art SPWM technology and output pure sine wave.
14. Advanced MPPT technology, the efficiency is as high as 99.9%.
15. LCD screen design, 3 LED indicator lights, dynamic display system data and running status.
16. Adopt intelligent adjustable speed fan to dissipate heat efficiently and prolong the service life of the system.
17. Complete short circuit protection, over-voltage and under-voltage protection, overload protection and backfeed protection available.

## 1.2 Introduction to the Basic System

The following figure shows the system application scenario of this Product. A complete system shall include the following parts:

1. PV Module: convert light energy into direct current energy, charge the battery through inverter, or directly invert into AC to supply power to the load.
2. Mains Power or Generator: connected at AC input, can supply power to the load and charge the battery at the same time. If no mains or generator is connected, the system can operate normally and the load power is supplied by batteries and PV module.
3. Battery: the function of battery is to ensure the normal power consumption of the system load when the solar energy is insufficient and there is no Mains Power.
4. Load of Household Appliances: can access to various loads of household and office appliances, including AC loads such as refrigerators, lamps, televisions, fans and air conditioners.
5. Reversing Control Inverter: energy conversion device of the whole system.

The specific system wiring mode is determined by the actual application scenario.

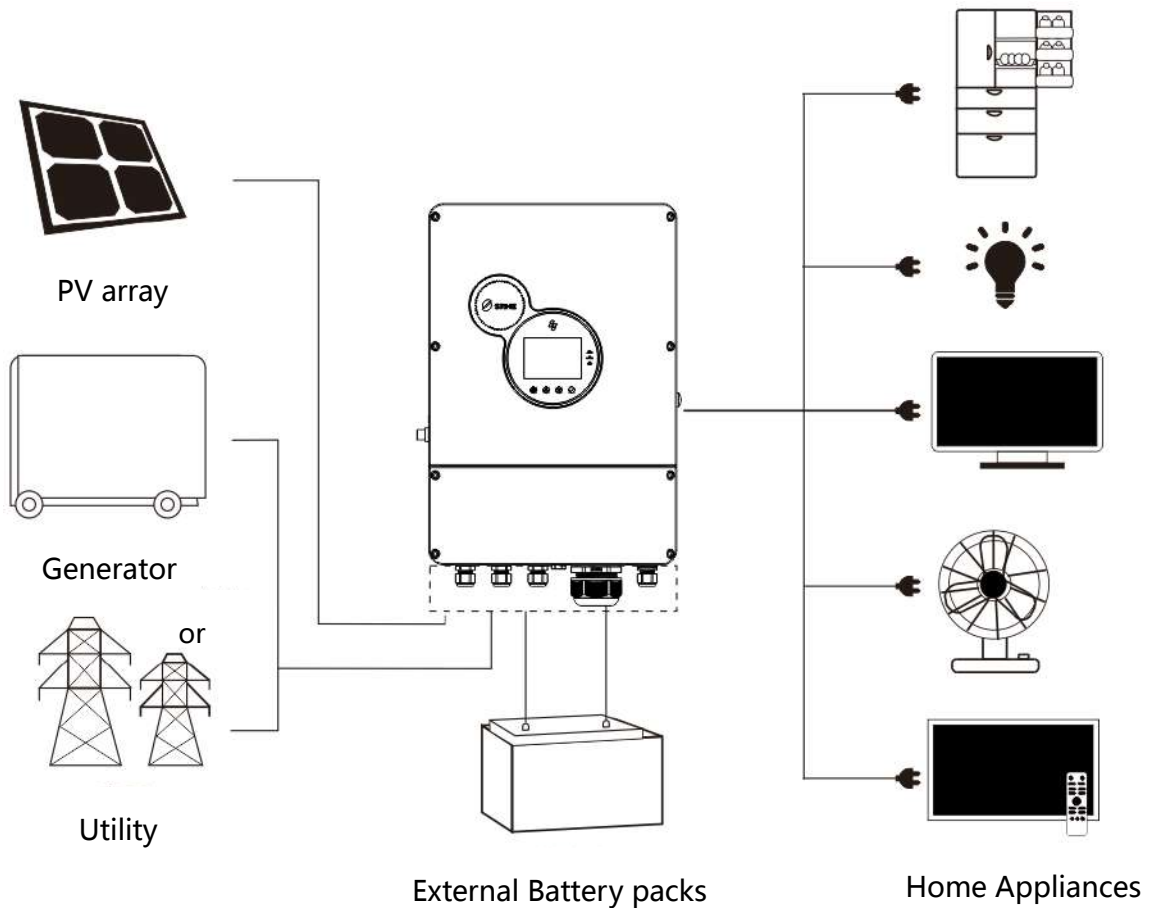

### 1.3 Product Features

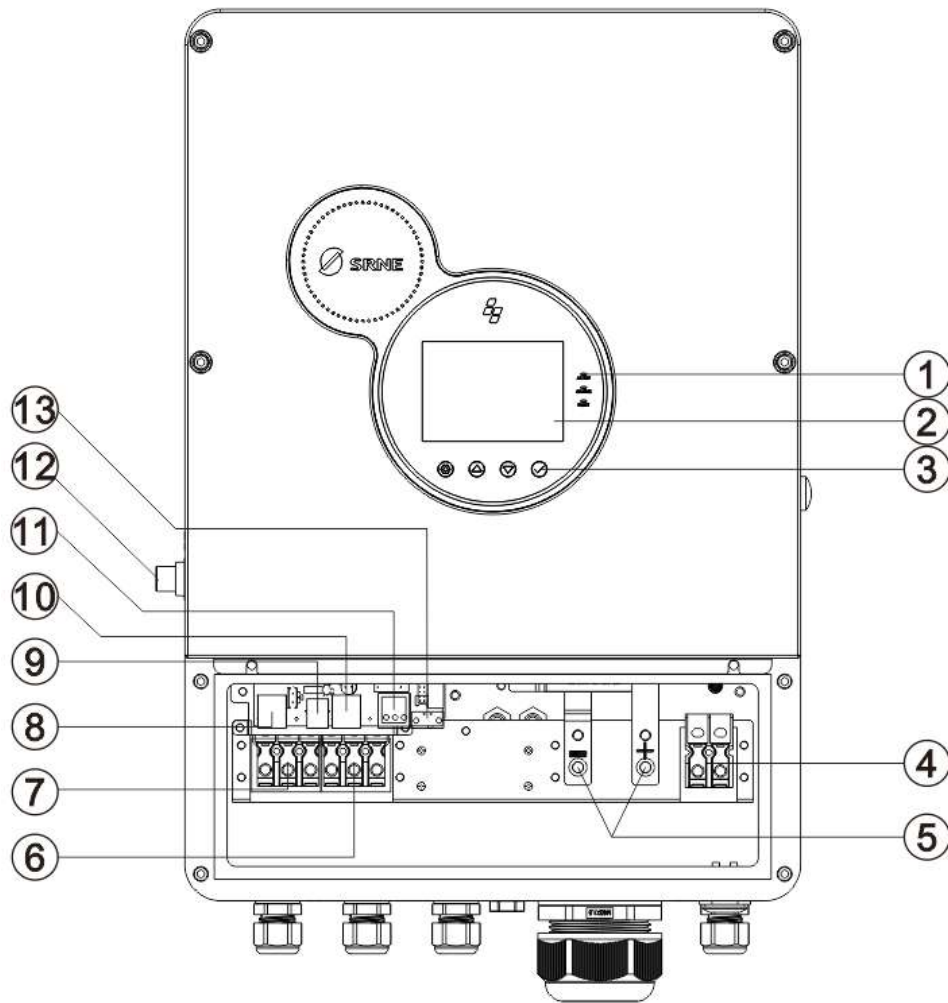

①	Indicator light	⑧	RS485-2 Communication Port
②	LCD screen	⑨	USB communication port
③	Touch button	⑩	RS485-1 Communication Port
④	PV terminal	⑪	Dry-contact port
⑤	Battery terminal	⑫	Overload protector
⑥	AC output	⑬	CAN communication port
⑦	AC input		

### 1.4 Dimensional Diagram

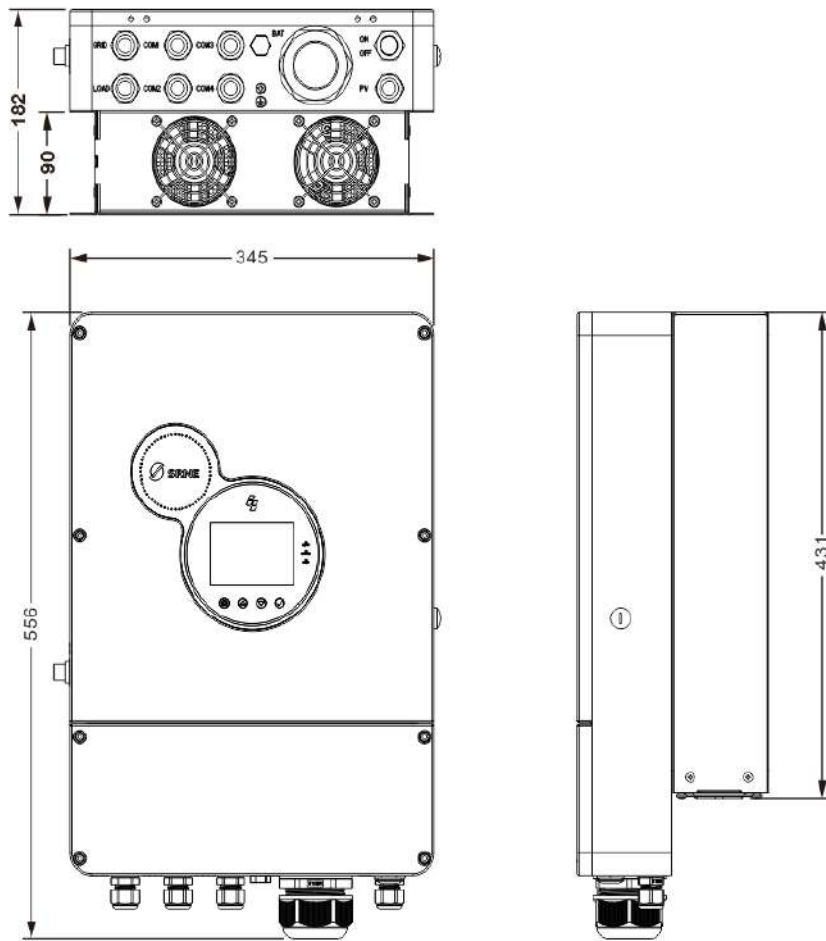

### Location of Mounting Holes

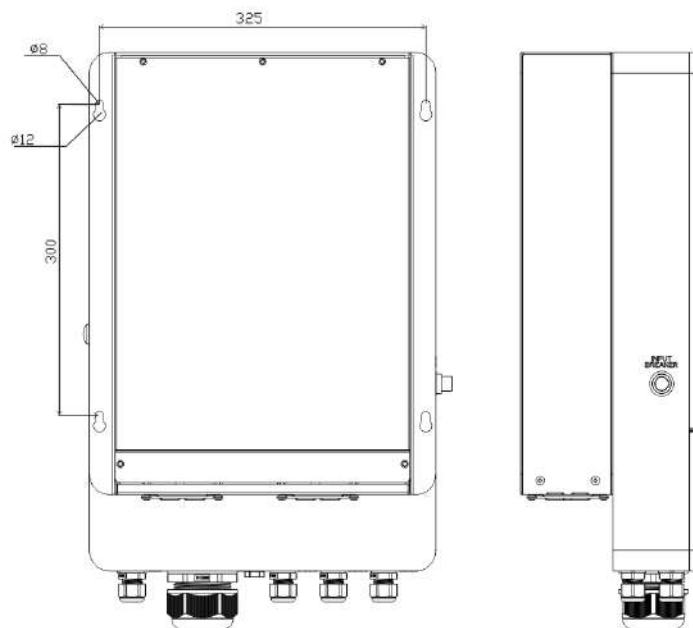

## 2. Installation Instructions

### 2.1 Precautions for Installation

Please read this Manual carefully to familiarize yourself with the installation steps before installing.

- Take great care when installing the battery. Wear protective goggles when installing the lead-acid liquid battery. Once contacting the acid solution of battery, please rinse with clear water in time.
- Avoid placing any metal object near the battery against short-circuiting.
- Acid gas may be generated when the battery is charged so as to ensure good ventilation of surroundings.
- When the cabinet is installed, it is necessary to leave enough space around the inverter for heat dissipation; Do Not install the inverter and the lead-acid liquid battery in the same cabinet, so as to prevent the acid gas generated when the battery works from corroding the inverter.
- Only the type of battery conforming to this inverter can be charged.
- Virtual junctions and corroded wires may cause great heat, melt the insulation of wire, burn the surrounding material, and even cause fire. Therefore, it is necessary to ensure that all connectors are tightened, and wires are preferably fixed with ties to avoid loose connectors caused by shaking of wires during mobile applications.
- The connection wire of the System shall be selected according to the current density no more than  $5A/mm^2$ .
- After the power is turned off, there is still high voltage inside the inverter. Please Do Not open or touch the internal devices, and Do Not carry out relevant operations until the capacitor is discharged.
- Please Do Not install the inverter in any flammable and explosive environment.
- No reverse polarity is allowed for the battery input of this product, otherwise, it is easy to damage the equipment or cause any unpredictable danger.
- The mains input and AC output are high voltage, so please Do Not touch the wire connector.
- When the fan is working, Do Not touch it to prevent injury.
- For the input power of load equipment, it is required to confirm that this Inverter is the only input equipment and it is forbidden to use it in parallel with any other input AC power source so as to avoid damage.

### 2.2 Wiring Specification and Circuit Breaker Selection

The wiring and installation methods must comply with national and local electrical specifications.

Recommended PV Array Wiring Specification and Circuit Breaker Selection: since the output current of PV array is affected by the type of PV module, connection mode and illumination angle, the minimum wire diameter of PV array is calculated according to the short-circuit current of PV array; please refer to the short-circuit current value in the specification of PV modules (the short-circuit current of PV modules is unchanged when they are connected in series; if in parallel, the short-circuit current will be the sum of the short-circuit current of all parallel modules); the short-circuit current of the array cannot exceed the maximum PV input current.



➤ **Refer to the following table for PV input wire diameter and switch:**

Models	Recommended PV wiring diameter	Maximum PV input current	Recommended circuit breaker model
HES4855S100-H	6mm <sup>2</sup> /10AWG	22A	2P—25A

Note: The input voltage of PV panels in series shall not exceed the maximum open-circuit voltage corresponding to the Model.

➤ **Refer to the following table for recommended AC input wire diameter and switch**

Models	Recommended AC input wiring diameter	Maximum bypass input current	Recommended circuit breaker model
HES4855S100-H	10mm <sup>2</sup> /7AWG	40A	2P—40A

Note: There is a corresponding circuit breaker at the input wiring of Mains Power, so no circuit breaker can be added.

➤ **Recommended Battery Access Wire Diameter and Switch Selection**

Models	Recommended battery wiring diameter	Rated battery discharge current	Maximum charging current	Recommended circuit breaker model
HES4855S100-H	30mm <sup>2</sup> /2AWG	125A	100A	2P—200A

➤ **Recommended AC Output Wiring Specification and Circuit Breaker Selection**

Models	Recommended AC output wiring	Rated output current	Maximum bypass output current	Recommended circuit breaker model
HES4855S100-H	10mm <sup>2</sup> /7AWG	24A	40A	2P—40A

**Note:** The wiring diameter is for reference only. If the distance between the PV array and the inverter or between the inverter and the battery is long, using thicker wire can reduce the voltage drop and improve the system performance.

**Note:** The above wiring diameters and circuit breakers are recommended only. Please select the appropriate wiring diameters and circuit breakers, as the case may be.

## 2.3 Installation and Wiring

### Installation Steps:

**Step 1:** Determine the installation position of the Inverter. If installing the inverter on wall, please make sure that there is enough air flowing through the heat sink of the Inverter, leaving 200mm operating space on the left and right of the Inverter and 500mm air inlet and outlet heat dissipation space on the top and bottom. Refer to the following complete machine installation diagram.



**Warning:** Danger of Explosion! NEVER install the Inverter and the lead-acid liquid battery in the same confined space! Do Not install in a confined space where the battery gas may accumulate.

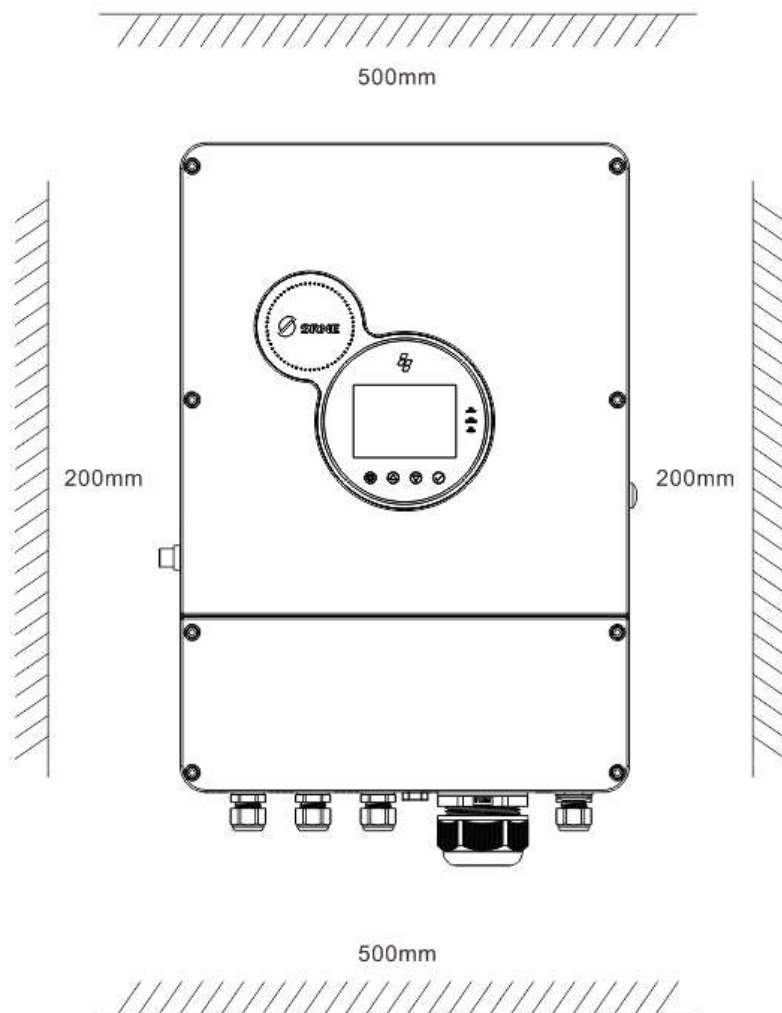

**Step 2:** Open 4 holes in the wall according to the following dimensions, and knock in expansion screws, as shown in the following figure:

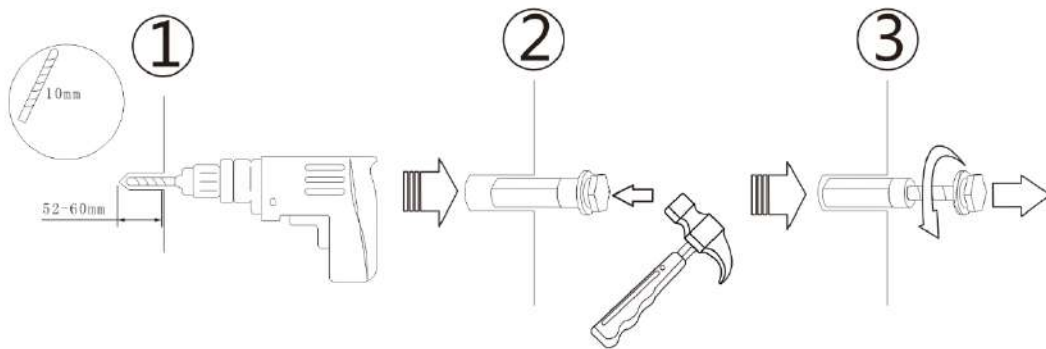
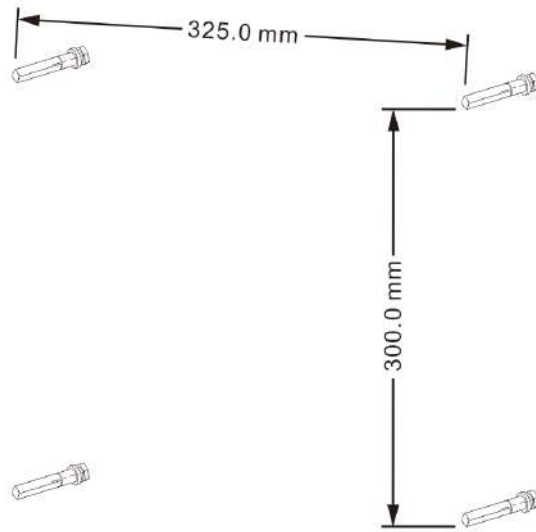

**Step 3:** Hang up the machine and tighten the screws.

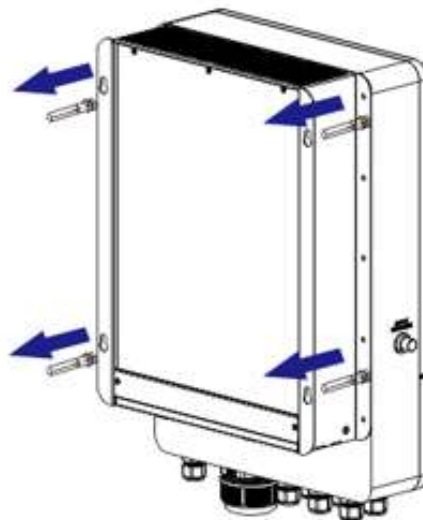

**Step 4:** Remove the terminal protection cover.

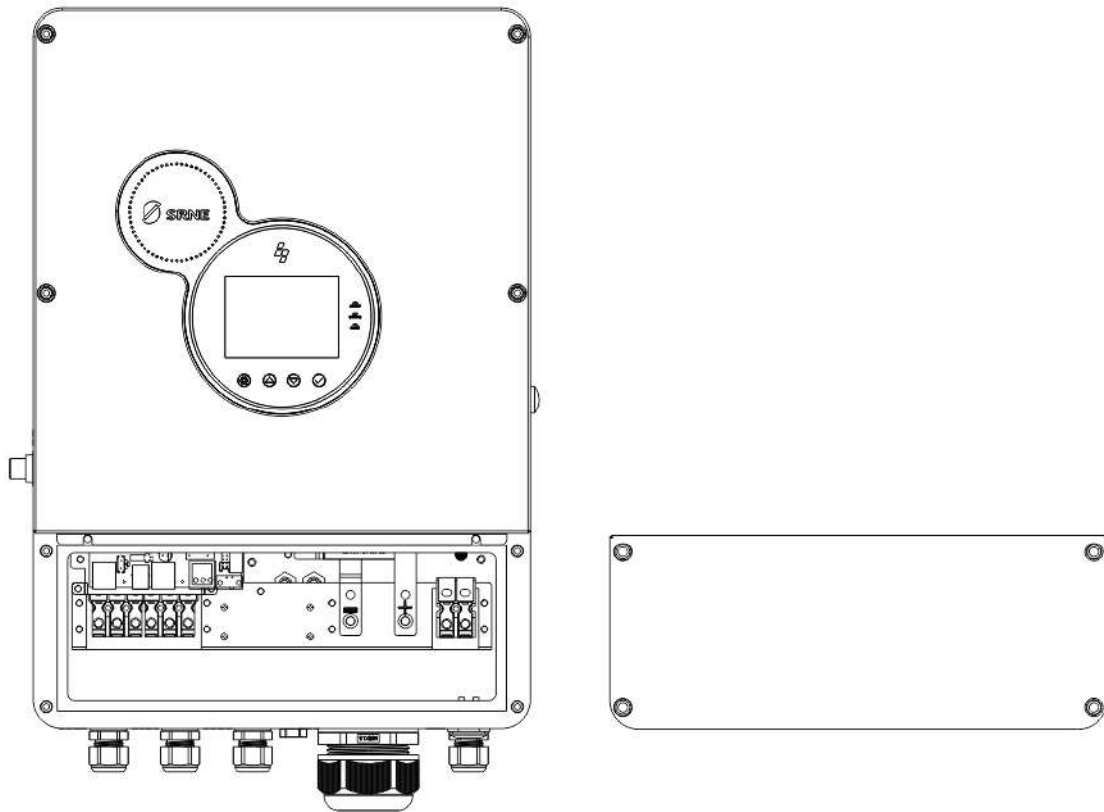

**Step 5:** Connect the Wire. (Note: The wire shall penetrate into the corresponding joint before crimping the terminal.)

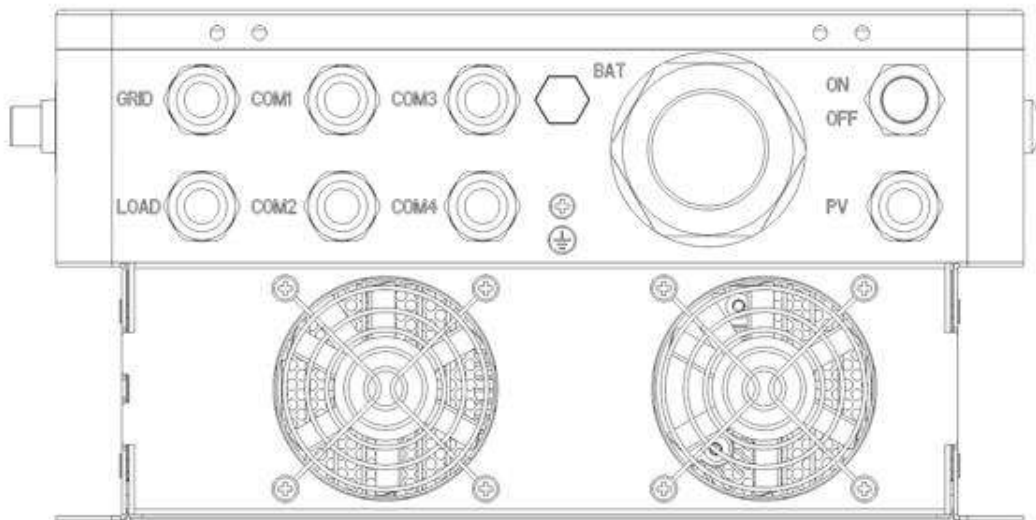

**Connection method of AC I/O:**

- ① Prior to AC I/O wiring, disconnect the external circuit breaker and confirm whether the cable used is thick enough. Please refer to Chapter "2.2 Wiring Specification and Circuit Breaker Selection";
- ② According to the cable sequence and terminal position shown in the following figure, connect the AC input line properly, please connect the grounding wire first, then connect the live wire and the neutral wire;

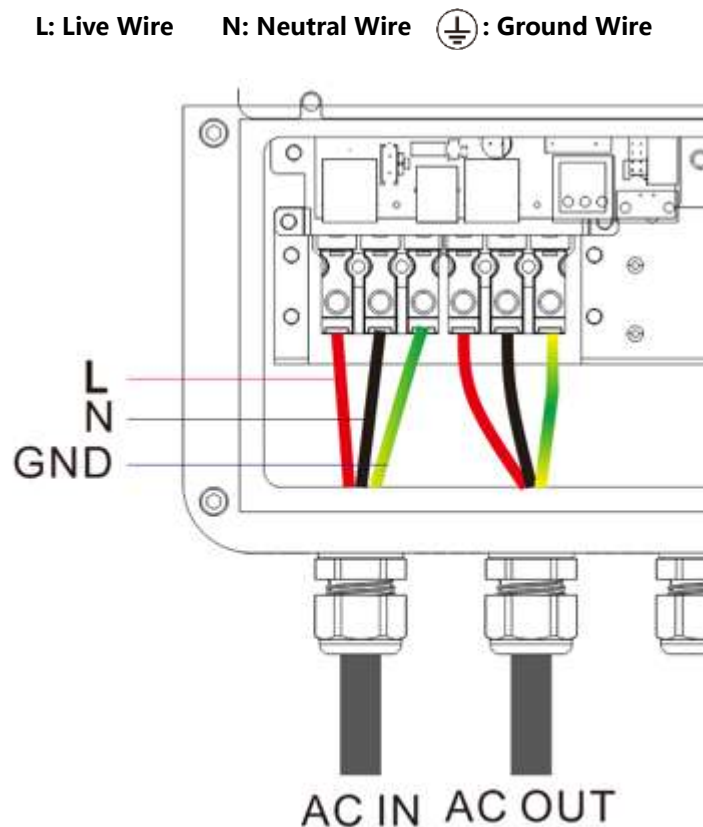

- ③ Connect the AC output line properly according to the cable sequence and terminal position shown in the above figure. Please connect the ground wire first, then the live wire and the neutral wire.

**Wiring Method of PV Input:**

- ① Prior to wiring, disconnect the external circuit breaker and confirm whether the cable used is thick enough. Please refer to Chapter "2.2 Wiring Specification and Circuit Breaker Selection";
- ② According to the cable sequence and terminal position shown in the following figure, connect the PV input line properly.

**BAT Wiring Method:**

- ① Prior to wiring, disconnect the external circuit breaker and confirm whether the cable used is thick enough. Please refer to Chapter "2.2 Wiring Specification and Circuit Breaker Selection". BAT wire shall be connected with the machine through O-terminal. It is recommended to use O-terminal with inner diameter of 7MM. The O-terminal must firmly compress BAT wire to prevent excessive heating caused by excessive contact impedance;
- ② According to the cable sequence and terminal position shown in the following figure, connect the BAT wire properly.

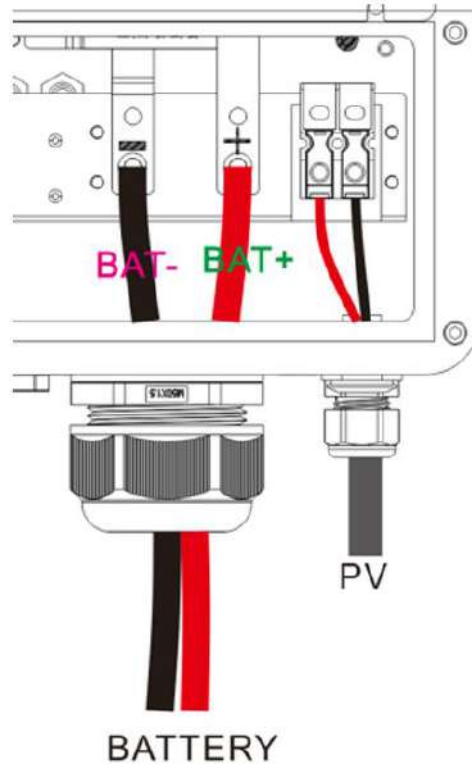

**Ground Wire of the Entire Machine:**

As shown in the following figure, it is located on the bottom of the chassis and shall be connected by O-terminal. It is recommended to use O-terminal with inner diameter of 6MM.

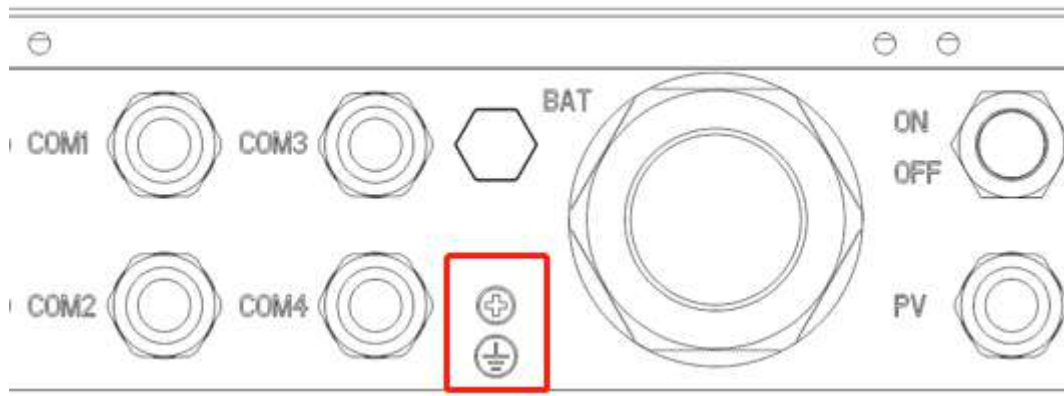

**Note:** As far as possible, the ground cable should be much thicker as possible (the sectional area of wire should not be less than 4mm<sup>2</sup>), and the grounding point should be kept close to the Inverter as possible. The ground wire shall be shorter as possible.

**Warning:**

- ① Please be sure to disconnect the circuit breaker or fuse prior to wiring, since the mains input, AC output and PV array will generate high voltage;
- ② Pay attention to safety in the process of wiring; Do Not close the circuit breaker or fuse, and ensure the "+" and "-" pole leads of each component be connected properly in the process of wiring; the circuit breaker must be

installed at the battery end. Please refer to Chapter 2.2 "Wiring Specification and Circuit Breaker Selection" for their selection;

prior to wiring, please be sure to disconnect the circuit breaker to prevent strong electric spark in the process of wiring and avoid short-circuiting the battery in the process of wiring; if the inverter is applied in any area with frequent lightning, it is recommended to install an external surge protection device at PV input.

**Step 6:** Check whether wires are connected properly and firmly, especially check whether the positive and negative of the battery input are reversely connected, whether the positive and negative of PV input are reversely connected and whether the AC input is improperly connected to the AC output.

**Step 7:** Tighten the waterproof joint cover and close the machine cover back.

**Step 8: Start the inverter**

First close the circuit breaker at the battery end, then press the circular ON/OFF switch on the right of the machine.

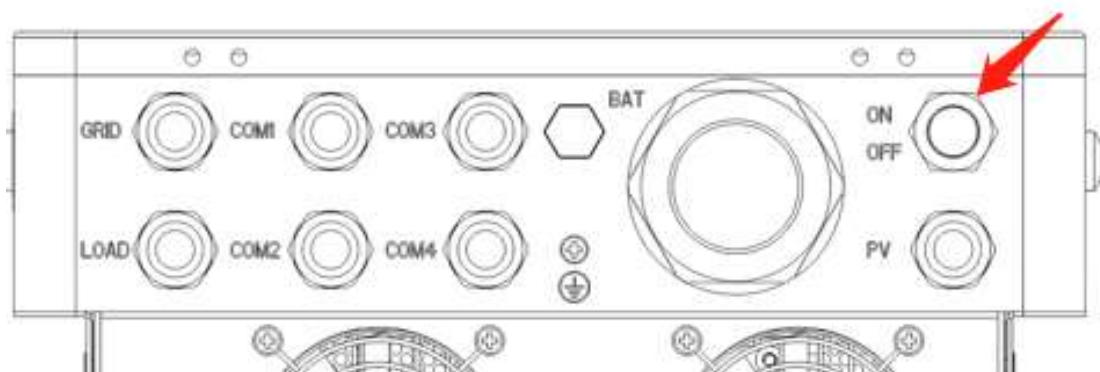

The flashing of "AC/INV" indicator lamp indicates that the inverter works normally. Close the circuit breaker of PV array and Mains Power again. Finally, open the AC load one by one after the AC output is normal so as to avoid protection action caused by major instantaneous impact caused by opening the load at the same time and ensure that the inverter work normally in the preset mode.

**Note:** If power is supplied to different AC loads, it is recommended to turn on the load with high impulse current first, and then turn on the load with small impulse current till the load can work stably.

**Note:** If the inverter is not working properly or the LCD or indicator light displays abnormally, please refer to Chapter 6 for troubleshooting.

### 3. Working mode

#### 3.1 Charging Mode

1. **Solar First:** priority shall be given to charging by PV, and mains charging will be started only when the PV has failed. It can fully utilize solar energy to generate power in the daytime and then switch to mains charging to keep the battery level, and can be used in regions where the grid is relatively stable and the feed-in tariff is relatively expensive.

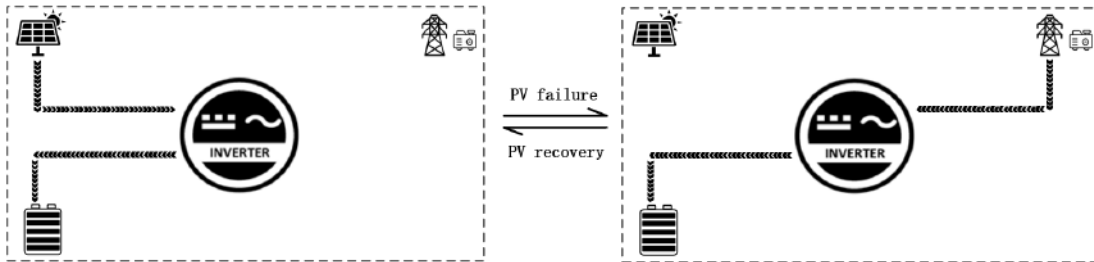

2. **Mains First:** priority shall be given to charging by Mains Power, and charging with PV power will be started only when the Mains has failed.

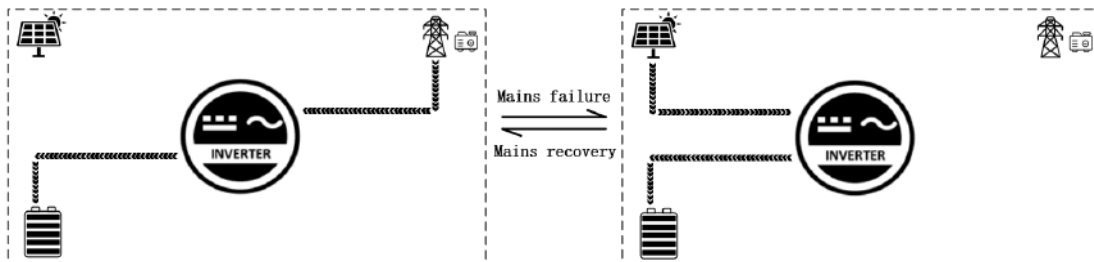

3. **Hybrid Charging:** hybrid charging of PV and Mains Power, give priority to PV MPPT charging, and supplement Mains Power when PV energy is insufficient. When the PV energy is sufficient, the Mains Power will stop charging. This is the mode of fast charging and suitable for unstable areas of power grid, and can provide sufficient backup power at any time.

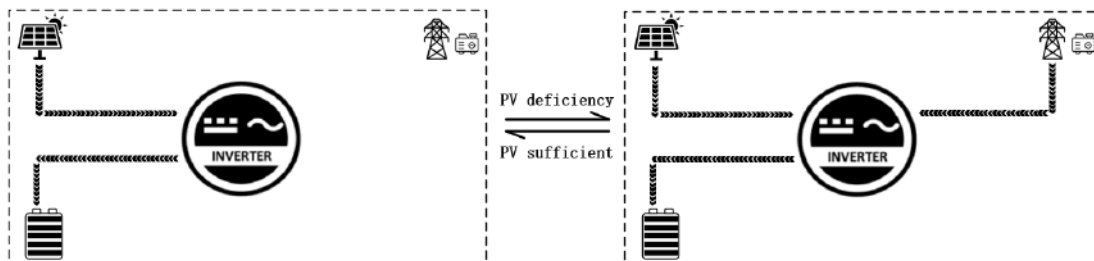

4. **Only Solar:** Only PV charging, no mains charging is initiated. This is the most energy-efficient mode and the battery power comes from solar energy, which is usually used in regions with good daylighting conditions.

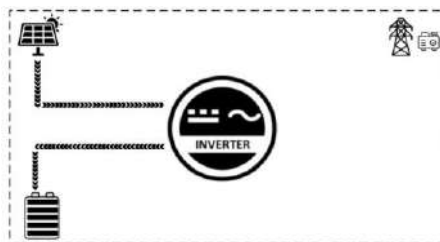



### 3.2 Output Mode

1. **Solar First:** PV and battery will power the load, with diversified charging modes available and output mode optional, when the Solar First Mode is selected, the use of green solar energy can be maximized for energy efficiency and emission reduction. Switch to Mains Power when PV has failed. This mode can maximize the use of solar energy while maintaining the battery power, which is suitable for regions with relatively stable power grid.

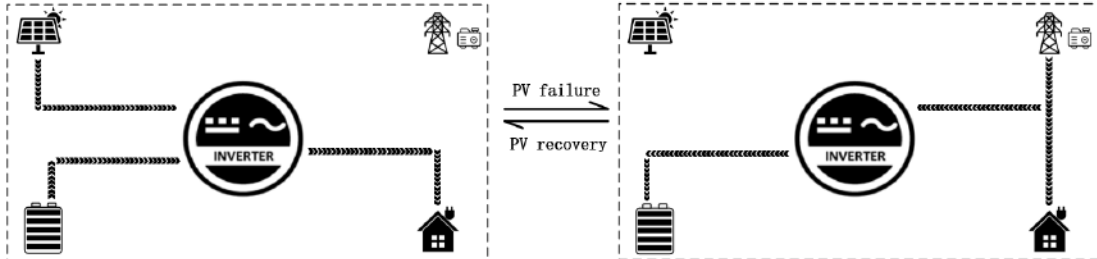

2. **Mains First:** switch to inverter power supply only when Mains Power has failed, which is equivalent to backup UPS and is used in regions with unstable power grid.

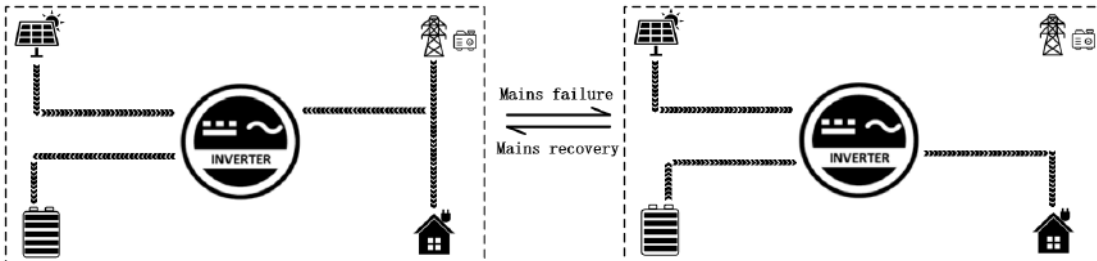

3. **Inverter First:** switch to Mains Power supply only when the battery is under-voltage. This mode uses DC energy to the maximum extent and is used in regions with stable power grid.

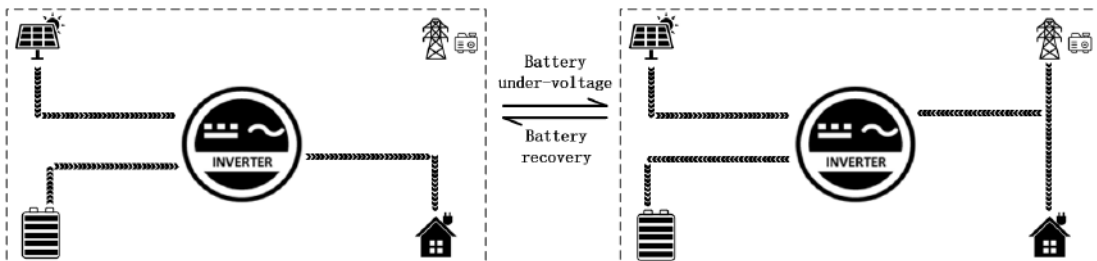

4. **Hybrid Function:** when the battery is not connected or fully charged, the load is powered with the hybrid of PV and Mains Power, with the maximum output power of PV output.

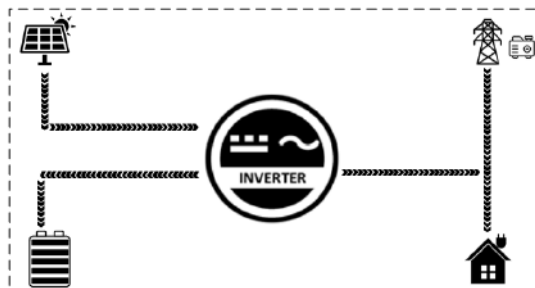

## 4. LCD Screen Operating Instructions

### 4.1 Operation and Display Panel

The operation and display panel is shown below, including one LCD screen, 3 indicator lights and 4 operation buttons.

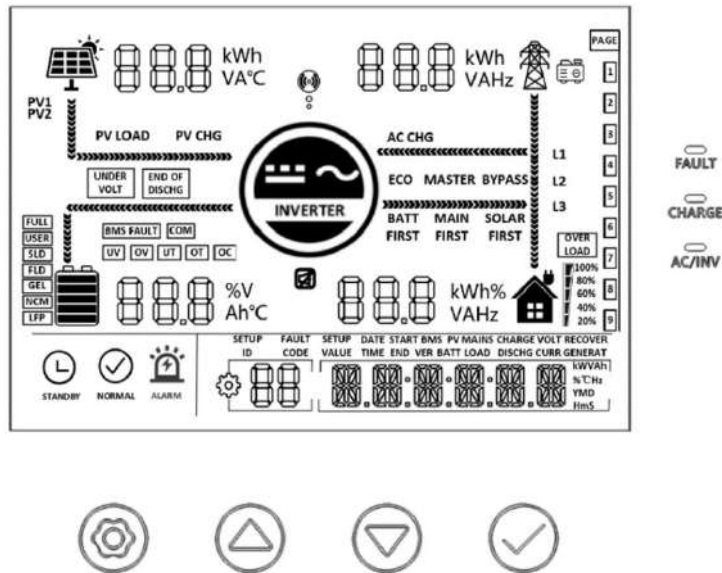

### 4.2 Introduction to Operation Keys

Function Key	Description
	Menu of Enter/Exit Settings
	Page Number/Option Increase
	Page Number/Option Decrease
	Under the menu of Settings, OK/Enter Options







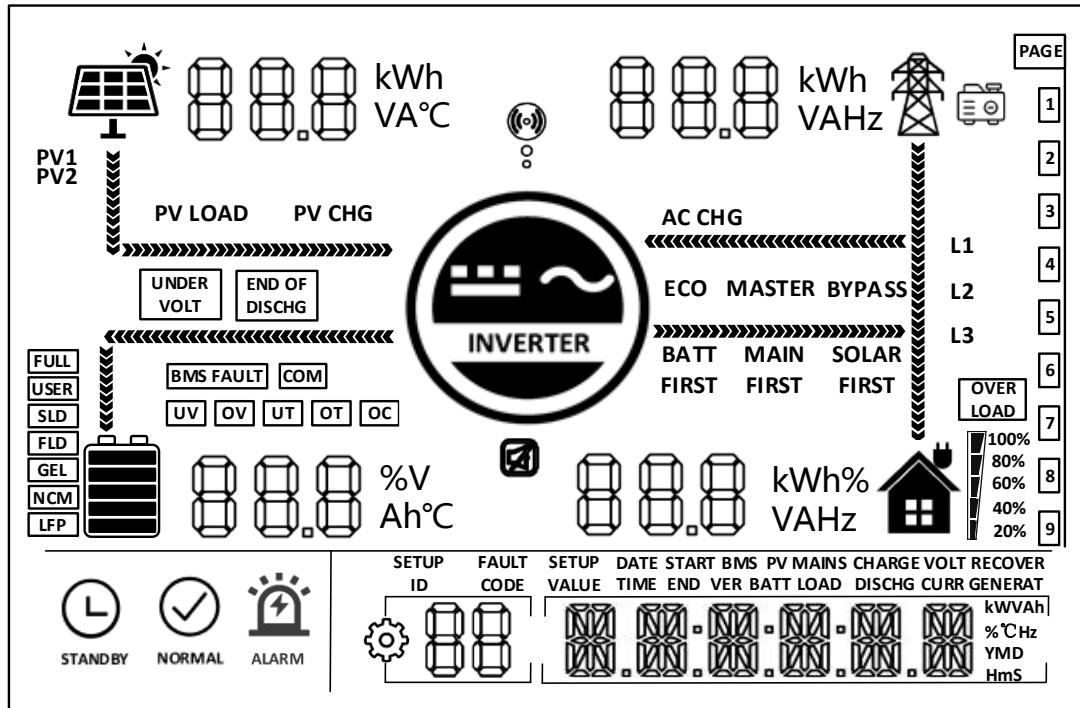















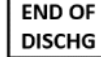

### 4.3 Introduction to Indicator Light

Indicator light	Color	Description
AC/INV	Yellow	Normally On: Mains Power output
		Flicker: Inverter output
CHARGE	Green	Flicker: The battery is being charged.
		Normally On: The charging is completed.
FAULT	Red	Normally On: Fault status



#### 4.4 Introduction to LCD Screen

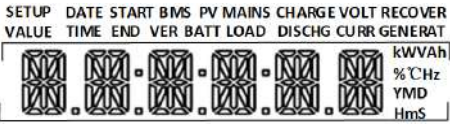

Icon	function	Icon	function
	Indicates mains power		Indicates the inverter is working
	Indicates generator		Indicates home appliances
	Indicates solar power		Indicates AC output is overload
	<ul style="list-style-type: none"> <li> Battery remaining capacity is below 5%</li> <li> Battery remaining capacity is 5%~19%</li> <li> Battery remaining capacity is 20%~39%</li> <li> Battery remaining capacity is 40%~59%</li> <li> Battery remaining capacity is 60%~79%</li> <li> Battery remaining capacity is 80%~100%</li> </ul>		<ul style="list-style-type: none"> <li> Load percentage is below 5%</li> <li> Load percentage is 5%~19%</li> <li> Load percentage is 20%~39%</li> <li> Load percentage is 40%~59%</li> <li> Load percentage is 60%~79%</li> <li> Load percentage is 80%~100%</li> </ul>
	Indicates that the machine is communicating with the Surveillance Equipment		Indicates that the buzzer is not enabled







	Indicates that the battery is fully charged		Indicates that the current battery type of the machine is user-defined
	Indicates that the current battery type of the machine is sealed lead-acid battery		Indicates that the current battery type of the machine is flooded lead-acid battery
	Indicates that the current battery type of the machine is gel battery		Indicates that the current battery type of the machine is NCM battery
	Indicates that the current battery type of the machine is LFP battery		Display the page number prompt of the main interface
			Indicates the data page of the main display interface
	Indicates that the machine is currently idle		Indicates that the machine is currently in normal operation
	Indicates that the machine is currently in an alarm or fault state		Indicates that the machine is currently in the parameter setting state
<b>PV LOAD</b>	Indicates that the PV is in a direct load state	<b>PV CHG</b>	Indicates that the PV is in a state of charge
<b>AC CHG</b>	Indicates that the AC is in a state of charge	<b>BYPASS</b>	Indicate that the Mains Power is in the bypass state
<b>ECO</b>	Indicates that the system is enabled in the ECO mode	<b>BATT FIRST</b>	Indicates that the output mode is Battery First
<b>MAIN FIRST</b>	Indicates that the output mode is Mains Power first	<b>SOLAR FIRST</b>	The indicated output mode is Solar First.
	Indicates battery under voltage		Indicates battery overvoltage
	Indicates internal communication failure		Indicates system under voltage
	Indicates system over voltage		Indicates system low temperature
	Indicates system over temperature		Indicates system over current
	Indicates BMS communication failure		Indicates the direction of energy flow
	When the system is in alarm or fault state, the main interface displays fault code; display setting options when setting		Display parameters of PV, battery, mains power and load
		Main Interface: display real-time time, date, total PV power generation, total load power consumption, RS485 address, version number Setting Interface: display setting contents	

## Real-time data viewing method

On the LCD main screen, press   the button for page turning to view the real-time data of the machine.

Page	PV side parameters	Battery side parameters	Mains side parameters	Load side parameters	Comprehensive parameters
1	PV Voltage	Battery Voltage	AC Voltage	Load Voltage	Current Time
2	PV Current	Battery Current	AC Current	Load Current	Current Date
3	PV Power	Reserved	AC Power	Load Power	PV Total kWh
4	PV Today kWh	Reserved	Reserved	Load Today kWh	Load Total kWh
5	PV Temperature	INV Temperature	AC Frequency	Load Frequency	RS485 Address
6	Maintenance Parm	Battery Rated Voltage	Reserved	Load kVA	Soft Version
7	PV Rated Voltage	Battery Rated Current	Reserved	Load Rated Power	Reserved

## 4.5 Description of Setting Parameters

Key Operation Instructions: Enter the setting menu and exit the setting menu, please press . After entering the setting menu, the parameter number [00] will flash. At this time, you can press the  and  key to select the parameter code to be set. Then press  to enter the parameter editing state, at this time, the value of the parameter flashes, adjust the value of the parameter through the  and , and finally press  to complete the editing of the parameter and return to the parameter selection state.

Parameter Number	Parameter Name	Setting options	Description
00	Exit	[00]ESC	Menu of Exit Settings
01	Supply Priority Mode	[01] AC1ST <b>Default</b>	Mains Power First Mode, switch to the Inverter only when the Mains Power has failed
		[01] BT1ST	Inverter First Mode: switch to Mains Power only when the battery is under-voltage or lower than Parameter [04] Set Value.
		[01] PV1ST	Solar First Mode: switch to Mains Power when PV has failed or battery is lower than Parameter [04] Set Value.
02	Output Frequency	[02] 50.0 <b>Default</b>	Bypass Adaptation: when there is Mains Power, automatically adapt to the frequency of Mains Power; when there is no Mains Power, set the output frequency of 230V machine by this Menu to 50Hz by fault.
		[02] 60.0	
03	AC Input Voltage	[03] UPS <b>Default</b>	The input mains voltage range of 230V machine is 170~280V
		[03] APL	The input mains voltage range of 230V machine is 90~280V
04	Battery to Mains	[04] 43.6V <b>Default</b>	When the Parameter [01] = BT1ST/PV1ST, the battery voltage is lower than the set value, and the output is switched from inverter to Mains Power, and the set range is 40V~52V.
05	Mains to Battery	[05] 56.8V <b>Default</b>	When the Parameter [01] = BT1ST/PV1ST, the battery voltage is higher than the set value, and the output is switched from mains to inverter, and the set range is 48V~60V.
06	Charging mode	[06] Hybrid <b>Default</b>	Hybrid charging by PV and under utility grid give priority to PV, and use utility grid for supplementary if PV energy is insufficient. When the PV energy is sufficient, the utility grid will stop charging. Note: PV and utility grid are available for charging at the same time only when the bypass output is loaded, and only PV charging can be

			activated when the inverter is working.
		[06] AC1ST	The Mains Power is charged first, and PV charging is started only when the Mains Power has failed
		[06] PV1ST	Priority shall be given to charging by PV and mains charging will be initiated only when the PV has failed.
		[06] ONLYPV	Only PV charging, no mains charging is enabled.
<b>07</b>	Maximum Charging Current	[07] 60A <b>Default</b>	Set Range of 0~100A
<b>08</b>	Battery type	[08] USER	User-defined, all battery parameters can be set.
		[08] SLd	Sealed lead-acid battery with constant charge voltage of 57.6V and floating charge voltage of 55.2V
		[08] FLd	Flooded lead-acid battery with constant charge voltage of 57.6V and floating charge voltage of 55.2V
		[08] GEL <b>Default</b>	GEL lead-acid battery with constant charge voltage of 56.8V and floating charge voltage of 55.2V
		[08 ]LFP14/LFP15/LFP16	LFP14/LFP15/LFP16 are corresponding to Battery Series of 14, 15 and 16, and their default constant charge voltages are 49.6V, 53.2V and 56.8V respectively, which can be adjusted.
		[08] NCM13/NCM14	NCM lithium battery, adjustable
<b>09</b>	Boost Voltage	[09] 57.6V <b>Default</b>	Setting of Boost Voltage: Set Range of 48V~58.4V, Step 0.4V, available when the battery type is user-defined and lithium battery.
<b>10</b>	Maximum Boost Duration	[10] 120 <b>Default</b>	Setting of Maximum Boost Duration, which is the maximum charging time when the voltage reaches the Parameter [09] when charging at constant voltage, with the Set Range of 5min~900min, and Step of 5min. It is available when the battery type is user-defined and lithium battery.
<b>11</b>	Float charge voltage	[11] 55.2V <b>Default</b>	Floating Charge Voltage, with the Set Range of 48V~58.4V, Step of 0.4V, and available when battery type is user-defined.
<b>12</b>	Over-discharge voltage	[12] 42V <b>Default</b>	Over-discharge Voltage: the battery voltage is lower than such criterion, and the Inverter output is turned off after the time delay parameter is set to [13], with the Set Range of 40V~48V and Step of 0.4V. available when the battery type is user-defined and lithium battery.
<b>13</b>	Over discharge Delay Time	[13] 5S <b>Default</b>	Over-discharge Delay Time: when the battery voltage is lower than the Parameter [12], the inverter output is turned off upon delay of time set by this Parameter, with the Set Range of 5S~50S, Step of 5S, available when the battery type is custom and lithium battery.
<b>14</b>	Battery under voltage	[14] 44V <b>Default</b>	Battery under-voltage alarm point: when the battery

	alarm point		voltage is lower than such criterion, under-voltage alarm will be given, the output will not be shut down, with the Set Range of 40V~52V, Step of 0.4V, available when battery type is user-defined and lithium battery.
15	Battery Discharge Limit Voltage	[15] 40V <b>Default</b>	Battery Discharge Limit Voltage: the battery voltage is lower than such criterion, output and shut down immediately. Set Range of 40V~52V, Step of 0.4V, available when the battery type is user-defined and lithium battery.
16	Equalization charge	[16] DIS	No equalization charging
		[16] ENA <b>Default</b>	Enable equalization charging, only Flooded lead-acid batteries, sealed lead-acid batteries and user-defined are effective
17	Equalization Voltage	[17] 58V <b>Default</b>	Equalization Charging Voltage, with the Set Range of 48V~58V, Step of 0.4V, available for Flooded lead-acid battery, sealed lead-acid battery and user-defined
18	Equalization Charging Time	[18] 120 <b>Default</b>	Equalization Charging Time, with the Set Range of min~900min, Step of 5min, available for Flooded lead-acid battery, sealed lead-acid battery and user-defined
19	Equalized Charging Delay	[19] 120 <b>Default</b>	Equalization Charging Delay, with the Set Range of min~900min, Step of 5min, available for Flooded lead-acid battery, sealed lead-acid battery and user-defined
20	Equalization Charge Interval Time	[20] 30 <b>Default</b>	Equalization Charge Interval Time, 0~30d, Step of 1d, available for Flooded lead-acid battery, sealed lead-acid battery and user-defined
21	Equalization Charging Start-Stop	[21] ENA	Start equalization charging immediately
		[21] DIS <b>Default</b>	Stop equalization charging immediately
22	ECO mode	[22] DIS <b>Default</b>	NO ECO mode
		[22] ENA	When the ECO mode is enabled, if the load is below 50W, the inverter output is delayed for 5 minutes and then the output is turned off. When the hull switch is pressed to the "OFF" State, and then pressed to the "ON" State, the inverter will resume the output
23	Overload Automatic Restart	[23] DIS	Overload automatic restart is disabled. If overload occurs, the output will be shut down, and the machine will not be restarted.
		[23] ENA <b>Default</b>	Enable overload auto restart. If overload occurs, shut down output, delay the machine for 3 min and then restart the output. After 5 times in total, no startup will be resumed.



24	Auto restart upon over-temperature	[24] DIS	Over-temperature automatic restart is disabled. If over-temperature occurs, the output will be shut down, and the machine will not be restarted for output.
		[24] ENA <b>Default</b>	Enable automatic restart upon over-temperature. If over-temperature occurs, shut down output, and restart output after the temperature has dropped.
25	Buzzer Alarm	[25] DIS	No Alarm
		[25] ENA <b>Default</b>	Enable alarm
26	Mode Change Reminder	[26] DIS	Alarm is disabled when the status of the main input source has change.
		[26] ENA <b>Default</b>	Alarm is disabled when the status of the main input source has change.
27	Inverter Overload to Bypass	[27] DIS	Automatic switch to Mains Power is disabled when the Inverter is overloaded.
		[27] ENA <b>Default</b>	Automatic switch to Mains Power when the inverter is overloaded.
28	Current of charging under grid electricity	[28] 60A <b>Default</b>	AC output 230Vac, with the Set Range of 0~60A
30	RS485 Address Setting	[30] 1 <b>Default</b>	RS485 communication address can be set within the range of 1~254
34	PV grid-connected power generation function	[34] DIS <b>Default</b>	Disable this Function
		[34] ENA	When the system supply mode is AC1ST and the battery is full or not-connected , the system with sufficient solar energy will work in grid-connected power generation mode
35	Battery Under-voltage Recovery Point	[35] 52V <b>Default</b>	When the battery is under-voltage, the battery voltage should be greater than this set value to restore the inverter AC output of the battery, and the set range is 44V~54.4V.
37	Battery Recharge Recovery Point	[37] 52V <b>Default</b>	After the battery is fully charged, the inverter will stop charging, and when the battery voltage is lower than this Value, the Inverter will resume charging again. And the set range is 44V~54V.
38	AC Output Rated Voltage	[38] 230Vac <b>Default</b>	You can set: 200/208/220/240Vac
40	1-section start charging time	[40] 00:00:00 <b>Default</b>	Set Range: 00: 00-23: 59: 00
41	1-section end charging time	[41] 00:00:00 <b>Default</b>	Set Range: 00: 00-23: 59: 00
42	2-section start charging time	[42] 00:00:00 <b>Default</b>	Set Range: 00: 00-23: 59: 00
43	2-section end	[43] 00:00:00 <b>Default</b>	Set Range: 00: 00-23: 59: 00

	charging time		
<b>44</b>	3-section start charging time	[44] 00:00:00 <b>Default</b>	Set Range: 00: 00-23: 59: 00
<b>45</b>	3-section end charging time	[45] 00:00:00 <b>Default</b>	Set Range: 00: 00-23: 59: 00
<b>46</b>	Sectional charging function	[46] DIS <b>Default</b>	Disable this Function
		[46] ENA	After the sectioned charging function is enabled, the power supply mode will change to BT1ST, and system will enable the mains power charging only in the set charging period or battery over discharge; If the sectioned discharge function is enabled at the same time, the power supply mode of the system will change to AC1ST, which only enable the mains charging in the set charging period, and switch to the battery inverter power supply mode in the set discharge period or when the mains power is off
<b>47</b>	1-section start discharging time	[47] 00:00:00 <b>Default</b>	Set Range: 00: 00-23: 59: 00
<b>48</b>	1-section end discharging time	[48] 00:00:00 <b>Default</b>	Set Range: 00: 00-23: 59: 00
<b>49</b>	2-section start discharging time	[49] 00:00:00 <b>Default</b>	Set Range: 00: 00-23: 59: 00
<b>50</b>	2-section end discharging time	[50] 00:00:00 <b>Default</b>	Set Range: 00: 00-23: 59: 00
<b>51</b>	3-section start discharging time	[51] 00:00:00 <b>Default</b>	Set Range: 00: 00-23: 59: 00
<b>52</b>	3-section end discharging time	[52] 00:00:00 <b>Default</b>	Set Range: 00: 00-23: 59: 00
<b>53</b>	Sectional discharge function	[53] DIS <b>Default</b>	Disable this Function
		[53] ENA	After the sectioned discharge function is enabled, the power supply mode will change to AC1ST and the system will switch to battery inverter power supply only during the set discharge period or when the mains power is off
<b>54</b>	Current date setting	[54] 00:00:00 <b>Default</b>	Set Range: 00:01: 01-99:12:31
<b>55</b>	Current time setting	[55] 00:00:00 <b>Default</b>	Set Range: 00:00: 00-23:59: 59
<b>56</b>	Leakage protection function	[56] DIS <b>Default</b>	Disable this Function
		[56]ENA	Enable leakage protection function

## 4.6 Battery Type Parameter List

### Lead acid battery:

<b>Battery type</b> <b>Parameter</b>	<b>Sealed lead acid (SLD)</b>	<b>Gel lead acid (GEL)</b>	<b>Flooded lead acid (FLD)</b>	<b>User-defined (User)</b>
Overvoltage break voltage	60V	60V	60V	60V
Equalization Voltage	58V	56.8V	58V	40~60V (adjustable)
Boost Voltage	57.6V	56.8V	57.6V	40~60V (adjustable)
Float charge voltage	55.2V	55.2V	55.2V	40~60V (adjustable)
Under-voltage alarm voltage	44V	44V	44V	40~60V (adjustable)
LV disconnection voltage	42V	42V	42V	40~60V (adjustable)
Discharge limit voltage	40V	40V	40V	40~60V (adjustable)
Over-discharge Delay Time	5s	5s	5s	1~30s (adjustable)
Equilibrium duration	120 min.	-	120 min.	0~600min (adjustable)
Equalization charging interval	30d	-	30d	0~250d (adjustable)
Boost duration	120 min.	120 min.	120 min.	10~600min (adjustable)

**Lithium battery:**

<b>Battery Type Parameters</b>	<b>NCM (NCM13)</b>	<b>NCM (NCM14)</b>	<b>LFP (LFP16)</b>	<b>LFP (LFP15)</b>	<b>LFP (LFP14)</b>	<b>User-defined (User)</b>
Overvoltage break voltage	60V	60V	60V	60V	60V	60V
Equalization Voltage	-	-	-	-	-	40~60V (adjustable)
Boost Voltage	53.2V adjustable	57.6V adjustable	56.8V adjustable	53.2V adjustable	49.2V adjustable	40~60V (adjustable)
Float charge voltage	53.2V adjustable	57.6V adjustable	56.8V adjustable	53.2V adjustable	49.2V adjustable	40~60V (adjustable)
Under-voltage alarm voltage	43.6V adjustable	46.8V adjustable	49.6V adjustable	46.4V adjustable	43.2V adjustable	40~60V (adjustable)
LV disconnection voltage	38.8V adjustable	42V adjustable	48.8V adjustable	45.6V adjustable	42V adjustable	40~60V (adjustable)
Discharge limit voltage	36.4V	39.2V	46.4V	43.6V	40.8V	40~60V (adjustable)
Over-discharge Delay Time	30s adjustable	30s adjustable	30s adjustable	30s adjustable	30s adjustable	1~30s (adjustable)
Equilibrium duration	-	-	-	-	-	Adjustable for 0~600min)
Equalization charging interval	-	-	-	-	-	0~250d (adjustable)
Boost duration	Adjustable for 120 min	Adjustable for 120 min	Adjustable for 120 min	Adjustable for 120 min	Adjustable for 120 min	10~600min (adjustable)

## 5. Other Functions

### 5.1 Dry contact Function

Working Principle: This dry contact can control the switch of diesel generator to charge the battery. (1) Under normal circumstances, this terminal is closed at NC-N point and opened at NO-N point; (2) when the battery voltage reaches the low-voltage breaking point, the coil of the relay is electrified, and the NO-N point is closed and the NC-N point is opened, at this time, the NO-N point can drive resistive load 125VAC/1A, 230VAC/1A and 30VDC/1A.

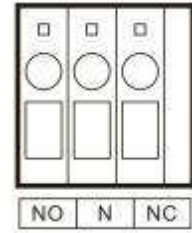

### 5.2 RS485 Communication Function

There are 2 communication ports: RS485-1 and RS485-2, which have two functions:

- ① RS485-2 communication port can communicate with lithium battery BMS in RS485 (need to be customized);
- ② RS485-1 communication port can be connected with the selected RS485 to WIFI/GPRS communication module independently developed by use. The Module, if selected, can be connected with our inverter, and the operating parameters and status of the inverter can be viewed through the mobile APP.
- ③ As illustrated in the figure:

Pin 1 is 5V power, Pin 2 is GND, Pin 7 is RS485-A and Pin 8 is RS485-B.

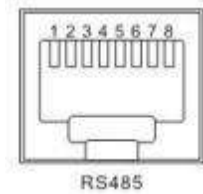

### 5.3 USB Communication Function

This is USB communication port, which can be used with our optional host computer (you need to apply)

Software for USB communication, using this Port needs to install the corresponding "USB to serial port chip CH340T Driver" in the computer.

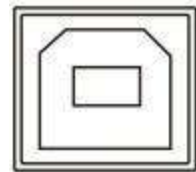

### 5.4 CAN Communication Interface

Communication port can communicate with lithium battery BMS (need to be customized), terminal left interface CANL, terminal right interface CANH.

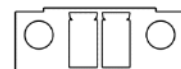

## 6. Protection

### 6.1 Protection Functions Available

SN	Protection function	Description
1	Current limiting protection	When the charging current of the configured PV array exceeds the PV rated current, charging will be at the rated current.
2	Protection against reverse charging in the nighttime	In the nighttime, since the voltage of battery is greater than that of the PV module, the battery is prevented from discharging through the PV module.
3	Input over-voltage protection	When the mains voltage exceeds 280V, charging under grid electricity will stop and turn to inverter output.
4	Under-voltage protection of Mains Power input	When the mains voltage is lower than 170V, charging under grid electricity will stop and turn to inverter output.
5	Battery over-voltage protection	When the battery voltage reaches the over-voltage breaking point, it will automatically stop PV and mains charging to prevent the battery from being damaged due to overcharging.
6	Battery low-voltage protection	When the battery voltage reaches the low-voltage breaking point, it will automatically stop discharging to prevent the battery from being damaged due to excessive discharge.
7	Load output short-circuiting protection	When a short-circuiting fault occurred at the load output terminal, the output AC voltage will be turned off immediately and output again after 1 min. If the output load terminal is still in a short circuit state after trying for 3 times, the short circuit fault of the load must be eliminated first, and then the power-on can be resumed manually.
8	Over-temperature protection of radiator	When the internal temperature of the inverter is too high, the inverter will stop charging and discharging; when the temperature returns to normal, the inverter will resume charging and discharging.
9	Overload protection	Output again 3 min after overload protection, shut down the output continuously for 5 times till the machine is powered on again. Refer to the technical parameter list attached to this Manual for specific overload level and duration.
10	AC back-feed protection	Prevent battery inverter AC from back-feed to bypass AC input.
11	Bypass over-current protection	Built-in AC input overcurrent protection circuit breaker.

## 6.2 Meaning of Fault Code

Fault Code	Fault	Whether the output is affected	Description
<b>[01]</b>	BatVoltLow	Yes	Battery under-voltage alarm
<b>[02]</b>	BatOverCurrSw	Yes	Software protection of battery discharge average overcurrent
<b>[03]</b>	BatOpen	Yes	Battery Disconnected Alarm
<b>[04]</b>	BatLowEod	Yes	Battery undervoltage stop discharge alarm
<b>[05]</b>	BatOverCurrHw	Yes	Hardware protection of battery overcurrent
<b>[06]</b>	BatOverVolt	Yes	Charging over-voltage protection
<b>[07]</b>	BusOverVoltHw	Yes	Hardware protection of bus over-voltage
<b>[08]</b>	BusOverVoltSw	Yes	Software protection of bus over-voltage
<b>[09]</b>	PvVoltHigh	No	PV over-voltage protection
<b>[10]</b>	PvBoostOCSw	No	Boost overcurrent software protection
<b>[11]</b>	PvBoostOCHw	No	Boost overcurrent hardware protection
<b>[12]</b>	bLineLoss	No	Mains Power failure
<b>[13]</b>	OverloadBypass	Yes	Bypass overload protection
<b>[14]</b>	OverloadInverter	Yes	Inverter overload protection
<b>[15]</b>	AcOverCurrHw	Yes	Hardware protection of inverter overcurrent
<b>[16]</b>	-	-	-
<b>[17]</b>	InvShort	Yes	Inverter short-circuiting protection
<b>[18]</b>	-	-	-
<b>[19]</b>	OverTemperMppt	No	Over-temperature protection of PV heat sink
<b>[20]</b>	OverTemperInv	Yes	Over-temperature protection of inverter heat sink
<b>[21]</b>	FanFail	Yes	Fan failure
<b>[22]</b>	EEPROM	Yes	Memory failure
<b>[23]</b>	ModelNumErr	Yes	Model setting error
<b>[26]</b>	Rlyshort	Yes	Inverter AC output back-feed to bypass AC output
<b>[29]</b>	BusVoltLow	Yes	Low bus voltage protection
<b>[57]</b>	LeakageCurrOver	Yes	Leak current OOS protection

### 6.3 Partial Troubleshooting Measures

Fault code	Faults	Handling measures
Display	No display on the screen	Check if the battery circuit breaker or the PV circuit breaker has been closed; if the switch is in the "ON" state; press any button on the screen to exit the screen sleep mode.
【06】	Battery overvoltage protection	Measure if the battery voltage exceeds rated, and turn off the PV array circuit breaker and Mains circuit breaker.
【01】 【04】	Battery under-voltage protection	Charge the battery until it returns to the low voltage disconnection recovery voltage.
【21】	Fan failure	Check if the fan is not turning or blocked by foreign object.
【19】 【20】	Heat sink over temperature protection	When the temperature of the device is cooled below the recovery temperature, normal charge and discharge control is resumed.
【13】 【14】	Bypass overload protection, inverter overload protection	① Reduce the use of power equipment; ② Restart the unit to resume load output.
【17】	Inverter short circuit protection	① Check the load connection carefully and clear the short-circuit fault points; ② Re-power up to resume load output.
【09】	PV over-voltage	Use a multimeter to check if the PV input voltage exceeds the maximum allowable input voltage rated.
【03】	Battery missed alarm	Check if the battery is not connected or if the battery circuit breaker is not closed.
【26】	Inverted AC Output Backfills to Bypass AC Input	Disconnect the AC input, PV input and battery input. After the screen is off, only connect the battery and start up. If fault 26 is reported, it indicates that the AC input relay switch is short-circuited, and you need to contact the manufacturer to replace it.



## 7. System Maintenance

➤ **In order to maintain the best long-term working performance, it is recommended to check the followings twice a year.**

1. Make sure that the airflow around the inverter is not blocked, and remove any dirt or debris from the heat sink.
2. Check whether the insulation of all exposed wires is damaged due to sun exposure, friction with any other surrounding object, dry rot, damage by insects or rats, etc. If necessary, repair or replace them.
3. Verify that the indications and displays are identical with the equipment operation. Please pay attention to any fault or error display and take corrective measures if necessary.
4. Check all terminals for signs of corrosion, insulation damage, high temperature or burning/discoloration, and tighten the terminal screws.
5. Check whether there is dirt, nesting insects and corrosion, and clean up as required.
6. If the surge protection device has failed, replace the failed arrester in time to prevent the inverter and even other equipment of users from being damaged by lightning.

**Warning: Danger of electric shock! In the process of the above operation, make sure that all powers of the inverter have been disconnected, and all capacitor powers are discharged, and then perform corresponding inspection or operation!**

➤ **We shall not assume any responsibility for the damage caused under the following circumstances:**

- ① Damage caused by improper use or any use in an inappropriate place.
- ② The open circuit voltage of PV module has exceeded the maximum allowable value.
- ③ Damage caused by the working environment temperature exceeding the limited range.
- ④ Disassembling and repair of the inverter without permission.
- ⑤ Damage caused by force majeure: damage occurred during transportation or loading and unloading of the inverter.

## 8. Technical Parameters

Type	HES4855S100-H
<b>Mains Power mode</b>	
Rated input voltage	220/230Vac
Input voltage range	(170Vac~280Vac) $\pm$ 2% (90Vac~280Vac) $\pm$ 2%
Frequency	50Hz/60Hz (auto detection)
Frequency range	47 $\pm$ 0.3Hz~55 $\pm$ 0.3Hz(50Hz); 57 $\pm$ 0.3Hz~65 $\pm$ 0.3Hz(60Hz);
Overload/short-circuit protection	Circuit breaker
Efficiency	>95%
Conversion time	10ms (typical)
(Bypass and Inversion)	
AC backfeed protection	Available
Maximum bypass overload current	40A
<b>Inverter mode</b>	
Output voltage waveform	Pure sine wave
Rated output power (VA)	5500 ( 4780/4970/5260/5500 )
Rated output power (W)	5500 ( 4780/4970/5260/5500 )
Power factor	1
Rated Output Voltage (Vac)	230Vac(200/208/220/240VacSettable )
Output voltage error	$\pm$ 5%
Output Frequency Range (Hz)	50Hz $\pm$ 0.3Hz/60Hz $\pm$ 0.3Hz
on-grid Max. power(W)	5000W(Manual Setup)
On-grid rated current(A)	22A
Efficiency	>90%
Overload Protection	(102%<load<125%) $\pm$ 10%: Error Message and shut down the output after 5 min; (125%<load<150%) $\pm$ 10%: Error Message and shut down the output after 10s; Load > 150% $\pm$ 10%: Error Message and shut down the output after 5s;
Peak power	11000VA
Motor loading capacity	4HP
Output short-circuit protection	Circuit breaker
Bypass Circuit Breaker Specification	40A
Rated battery input voltage	48V (minimum starting voltage of 44V)

Battery voltage range	40Vdc-60Vdc $\pm$ 0.6 Vdc (under-voltage alarm/shutdown voltage/over-voltage alarm/over-voltage recovery ... LCD screen can be set)
Power saving mode	Non-ECO mode $\leq$ 100W; ECO mode $\leq$ 50W
<b>Charging under Grid Electricity</b>	
Battery type	Lead-acid or lithium battery
Maximum Charging Current	60A
Charging current error	$\pm$ 5A <sub>dc</sub>
Charging voltage range	40-58V <sub>dc</sub>
Short circuit protection	Circuit breaker and blown fuse
Circuit breaker specification	40A
Overcharge protection	Warn and turn off charging after 1 min
<b>Solar charging</b>	
Maximum PV open-circuit voltage	500V <sub>dc</sub>
PV Operating Voltage Range	120-500V <sub>dc</sub>
MPPT voltage range	120-450V <sub>dc</sub>
Maximum PV input current	22A
Maximum PV input power	6000W
Battery voltage range	40-58V <sub>dc</sub>
PV charging current range (settable)	0-100A
Charging short-circuit protection	Blow a fuse
Wiring protection	Reverse polarity protection
<b>Certification Specification</b>	
Specification Certification	CE(IEC62109-1)/FCC
EMC Certification Level	EN61000
Operating Temperature Range	-25°C~55°C (>45°C derating)
Storage temperature range	-25°C~60°C
Humidity range	0%to100%
Noise	$\leq$ 60dB
IP rate	IP65
Heat sinking	Forced air cooling, with air speed adjustable
Communication interface	USB/RS485 (WiFi/GPRS)/CAN/Dry contact Control
Dimension (L*W*D)	556mm*345mm*182mm
Weight	19.2kg



- **Google browser**, scan the QR code to download the APP
- In the Google Play Store, search for "**SmartESS**" to download and install