

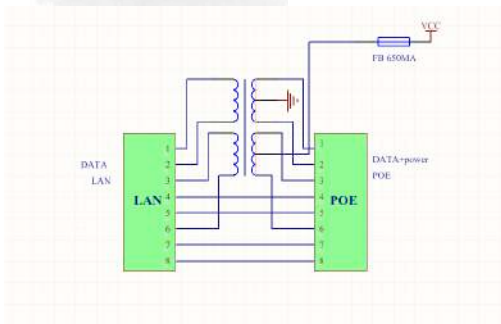

## GPOE-8 for 802.3af or passive 802.3at mode A power for 8 Gigabit devices



- PoE-World Brand Injectors
- 8 Port Gigabit Ethernet Injector
  - 8 Shielded RJ-45 LAN
  - 8 Shielded RJ-45 LAN+POE
  - 10/100/1000 data rates
- Injector: 180 mm x 45mm x 25mm including 2x 10mm tabs
- Wall mount - stackable
- 650 ma automatic resettable fuse on each port
- Same voltage to all ports - power is shared as needed by the devices
- Use with any Ethernet switch
  - PoE or non-PoE switches
- Standard power connector
  - 2.1mm x 5.5mm
- Additional Phoenix DC connector
  - 3.5mm model 1844236
  - pin 2 (minus) 3 (plus)
- LED status indicator
- Operating Temperature
  - 0 to 65 deg C
- Mode A operation
  - pins 1-2 (-)
  - pins 3-6 (+)
  - reversing cable available
- Ideal for IP Cameras, VOIP phone, WiFi Access Points
- Select the power supply you need
  - 48 or 56 volts
- Power is always on
  - no auto-negotiation
  - powers 802.3af / 802.3at devices “passively”
- Use our reversing jumper for reverse polarity if needed ( WS-Cisco )

### Power Input

Device Spec	Mode A - DC Input RJ45 pins 1,2- 3,6+	Note
Passive 802.3at	56 volts 120 watts	Please see WT-AT-8 for active PoE
802.3af or “12v, PoE”	48 volts 60 or 120 watts	IP Phones need about 5w each Other devices up to 15w each

(sometimes misspelled as GPOE-8)