



AN6000 Series

Optical Line Terminal Equipment

Product Description

Version: A

Code: MN000004287

FiberHome Telecommunication Technologies Co., Ltd.

November 2019

Thank you for choosing our products.

We appreciate your business. Your satisfaction is our goal. We will provide you with comprehensive technical support and after-sales service. Please contact your local sales representative, service representative or distributor for any help needed at the contact information shown below.

Fiberhome Telecommunication Technologies Co., Ltd.

Address: No. 67, Guanggu Chuangye Jie, Wuhan, Hubei, China

Zip code: 430073

Tel: +6 03 7960 0860/0884 (for Malaysia)

+91 98 9985 5448 (for South Asia)

+593 4 501 4529 (for South America)

Fax: +86 27 8717 8521

Website: <http://www.fiberhomegroup.com>

Legal Notice

烽火通信®

FiberHome®

GONST®

FONST®

e-Fim®

CiTRANS®

E-jet®

IBAS®

Freelink®

FonWeaver®

OTNPlanner™

SmartWeaver™

are trademarks of FiberHome Telecommunication Technologies Co., Ltd.
(Hereinafter referred to as FiberHome)

All brand names and product names used in this document are used for identification purposes only and are trademarks or registered trademarks of their respective holders.

All rights reserved

No part of this document (including the electronic version) may be reproduced or transmitted in any form or by any means without prior written permission from FiberHome.

Information in this document is subject to change without notice.

Contents

1	Documentation Guide	1
2	Product Introduction.....	3
2.1	Product Positioning.....	4
2.2	Subrack Configuration	4
2.2.1	AN6000-17	4
2.2.2	AN6000-15	6
2.2.3	AN6000-7	8
2.3	Matching PDPs.....	10
2.4	Matching Cabinet.....	11
3	Product Highlights.....	13
3.1	Smooth Evolution to the Next-Generation PON	14
3.2	Service Processing Capability.....	16
3.3	Integrated Access to Multiple PONs	16
3.4	Network Slicing Technology	17
3.5	VXLAN Technology.....	17
3.6	Environmentally-Friendly Design.....	20
3.7	HQoS	21
4	Product Specification	22
4.1	AN6000-17	23
4.2	AN6000-15	25
4.3	AN6000-7	28
4.4	Environment and Grounding Requirements for Equipment Rooms / Outdoor Cabinets.....	31
5	Product Function	33
5.1	List of Functions and Features	34
5.2	PON Access Function.....	37
5.2.1	EPON Access Function	37

	5.2.2	GPON Access Function	40
	5.2.3	10G EPON Access Function	43
	5.2.4	XG-PON Access Function.....	46
	5.2.5	XGS-PON Access Function	49
5.3		Layer 2 Function	52
	5.3.1	VLAN Function	52
	5.3.2	Layer 2 Forwarding Strategy	58
5.4		Voice Service Function	59
5.5		Multicast Service Function	62
5.6		Network Slicing Function.....	65
5.7		VXLAN Function	67
5.8		Layer 3 Function	70
	5.8.1	OSPF Function	70
	5.8.2	DHCP Relay Function.....	72
	5.8.3	ARP Proxy Function	74
5.9		Time and Clock Synchronization Function	76
5.10		QoS Function	77
5.11		Reliability Function.....	81
	5.11.1	Equipment Reliability	81
	5.11.2	ERPS Function.....	83
	5.11.3	MSTP Function.....	85
5.12		Security Function.....	87
5.13		Maintenance and Management Function.....	92
	5.13.1	Maintenance Function.....	93
	5.13.2	Network Management Function.....	95
6		Product Structure.....	100
	6.1	Logical Architecture	101
	6.2	Software Architecture.....	102
7		Standards and Protocols.....	104
	7.1	Environment Standards	105
	7.2	EMC Standards	106
	7.3	Safety Standards.....	108

7.4	Standards for PON Access	109
7.5	Standards and Protocols for Services.....	110
7.6	Standards for Network Protection.....	112
7.7	Standards for Layer 3 Functions.....	113
7.8	Other Standards	114
8	Abbreviations.....	115

1 Documentation Guide

Document Orientation

Product Description gives a general introduction to the positioning, highlights, specifications, functions, and structures of the AN6000 Series to help users get an overall knowledge about the equipment.

Intended Readers

- ◆ Marketing personnel
- ◆ Commissioning engineers
- ◆ Operation and maintenance engineers

Version Information

Version	Description
A	Initial version.

Content

Chapter	Summary
Product Introduction	<ul style="list-style-type: none">◆ Product positioning◆ Configuration of the AN6000 Series subracks◆ Matching PDPs◆ Matching cabinets
Product Highlights	<ul style="list-style-type: none">◆ Smooth evolution of the passive optical network (PON)◆ Service processing capability◆ Integrated access to multiple PONs◆ Network slicing technology◆ VXLAN technology◆ Environmentally-friendly design◆ HQoS
Product Specification	<ul style="list-style-type: none">◆ Main technical specifications of the AN6000 Series equipment◆ Equipment room / outdoor cabinet environment and grounding requirements

Chapter	Summary
Product Function	<ul style="list-style-type: none"> ◆ List of functions and features ◆ PON access functions: EPON, GPON, 10G EPON, XG-PON and XGS-PON ◆ Layer 2 functions: VLAN and Layer 2 forwarding strategy ◆ Voice service function ◆ Multicast service function ◆ Network slicing function ◆ VXLAN function ◆ Layer 3 functions: OSPF, DHCP Relay and ARP Proxy ◆ Time and clock synchronization function ◆ QoS function ◆ Reliability functions: equipment reliability, ERPS and MSTP ◆ Security function ◆ Maintenance and management functions: flexible port mirroring, remote mirroring, emulation test and network management system
Product Structure	Logical architecture and software architecture
Standards and Protocols	International standards, operators' standards and communications protocols

Related Documentation

Document	Applied To
<i>AN6000 Series Optical Line Terminal Equipment Hardware Description</i>	Network planning phase
<i>AN6000-17 Optical Line Terminal Equipment Quick Installation Guide</i>	Network deployment phase / network maintenance phase
<i>AN6000-15 Optical Line Terminal Equipment Quick Installation Guide</i>	Network deployment phase / network maintenance phase
<i>AN6000-7 Optical Line Terminal Equipment Quick Installation Guide</i>	Network deployment phase / network maintenance phase
<i>AN6000 Series Optical Line Terminal Equipment UNM2000 Configuration Guide</i>	Network deployment phase / network maintenance phase
<i>AN6000 Series Optical Line Terminal Equipment CLI Configuration Guide</i>	Network deployment phase / network maintenance phase

2 Product Introduction

This chapter introduces the positioning, subrack configurations and matching PDPs and cabinets of the AN6000 Series.

- Product Positioning
- Subrack Configuration
- Matching PDPs
- Matching Cabinet

2.1 Product Positioning

The AN6000 Series are brand-new next-generation intelligent optical line terminal devices that provide users with integrated service access solutions featuring large capacity, high bandwidth and low cost, so as to meet the demand of rapidly growing broadband services.

The AN6000 Series provide access solutions for multiple services such as GPON, 10G EPON, XG-PON and XGS-PON services, supporting various access scenarios such as FTTH, FTTB, FTTO, FTTC, FTTA, FTTDP and FTTM, catering to service scenarios such as smart home access, government / enterprise group customer access , and 5G fronthaul, with all the services carried by an optical fiber network.

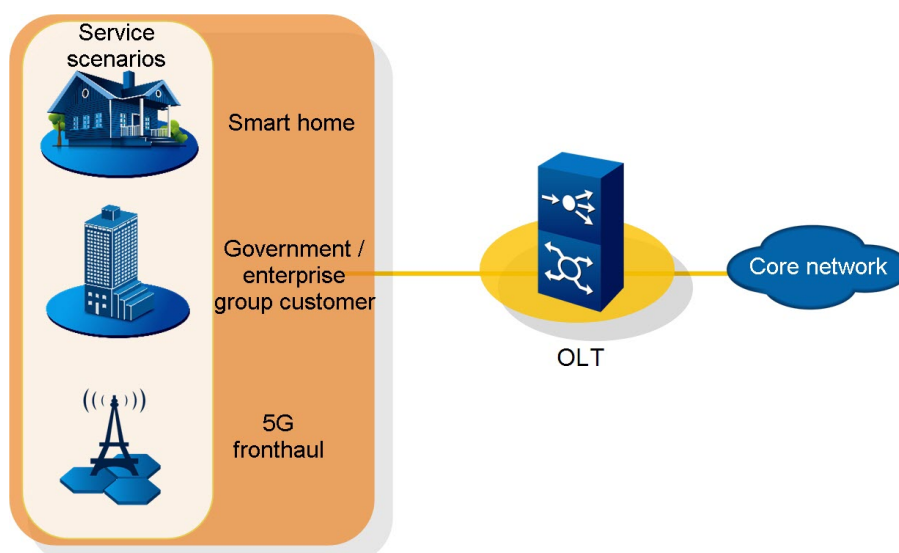

2.2 Subrack Configuration

This section introduces the appearance, structure, slot distribution and supported cards of the AN6000 Series subracks.

2.2.1 AN6000-17

The AN6000-17 is a large-sized optical line terminal device deployed in a central office. Providing 17 service slots and featuring large capacity and high bandwidth, the device can cater to the access demand in a densely-populated area.

Appearance and Structure

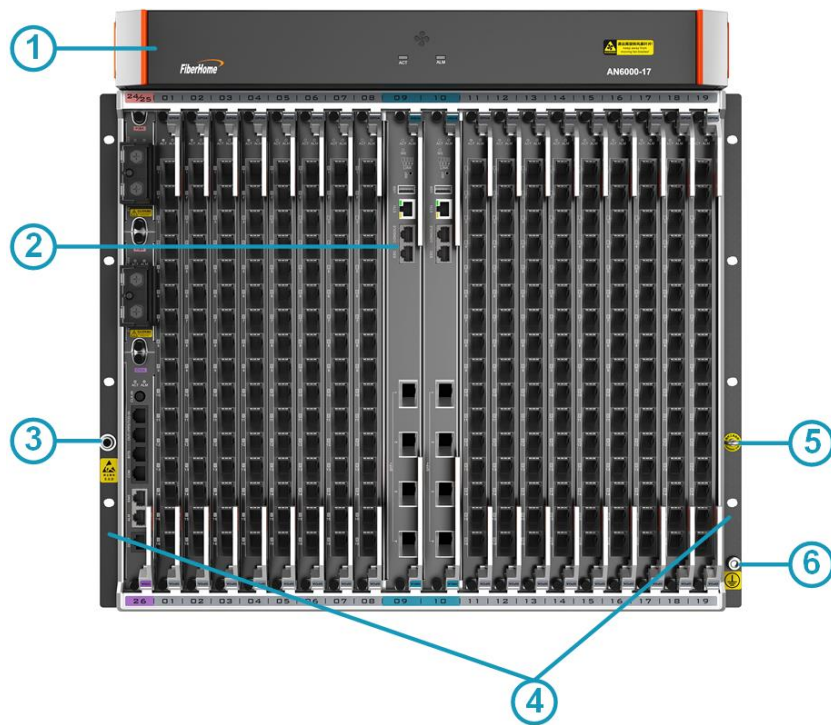

No.	Name	Function
①	Horizontal card slot	Houses the fan unit.
②	Vertical card slot	Accommodates cards to implement various functions of the equipment.
③	ESD protection earth ground fastener	Connects to the ESD protection device.
④	Mounting ear	Secures the subrack in the cabinet.
⑤	Fiber puller hanger	Holds the fiber puller.
⑥	Subrack earth ground point	Connects to the subrack protection earth ground cable.

Slot Distribution

The AN6000-17 subrack has 22 vertical slots and one horizontal slot.

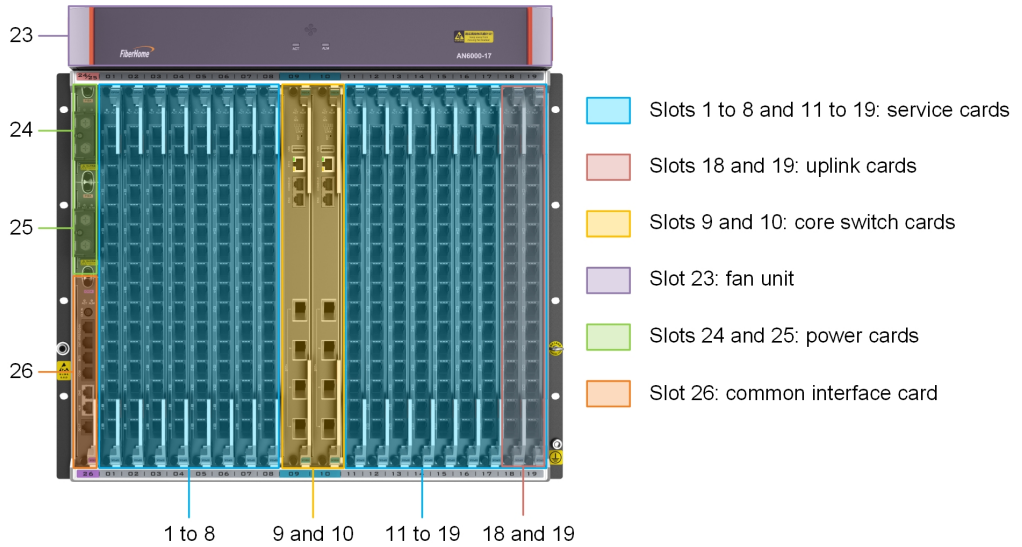

Card Supported

The slots can be classified as follows according to the cards they house:

Type	Slot	Card Supported
Service card slot	1 to 8, 11 to 19	GPOA, EX8A, EXOA, GX8A, GM8A, GMOA and GNOA
Uplink card slot	18 and 19	HU8A
Core switch card slot	9 and 10	HSCA
Fan unit slot	23	FAN
Power card slot	24 and 25	PIBA
Common interface card slot	26	CIOA

2.2.2 AN6000-15

The AN6000-15 is a large-sized optical line terminal device deployed in a central office. Providing 15 service slots and featuring large capacity and high bandwidth, the device can cater to the access demand in a densely-populated area.

Appearance and Structure

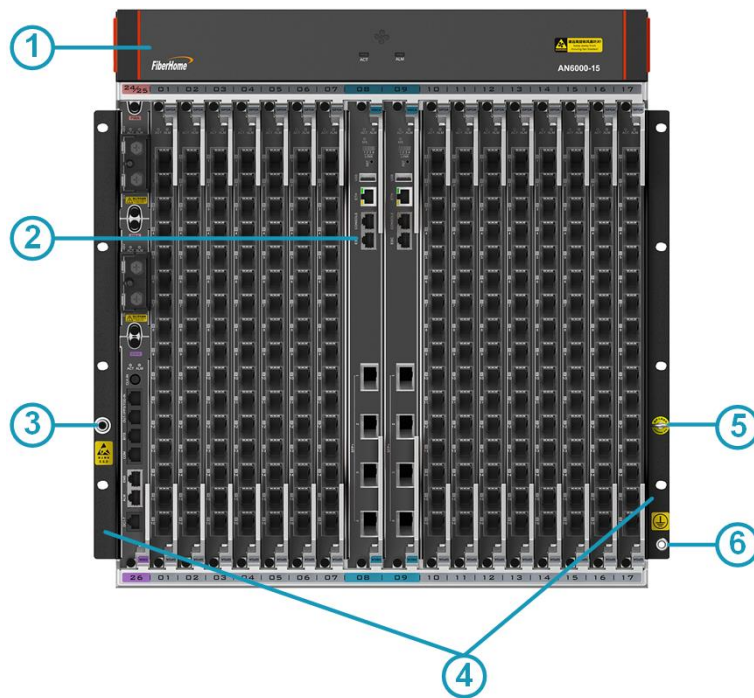

No.	Name	Function
①	Horizontal card slot	Houses the fan unit.
②	Vertical card slot	Accommodates cards to implement various functions of the equipment.
③	ESD protection earth ground fastener	Connects to the ESD protection device.
④	Mounting ear	Secures the subrack in the cabinet.
⑤	Fiber puller hanger	Holds the fiber puller.
⑥	Subrack earth ground point	Connects to the subrack protection earth ground cable.

Slot Distribution

The AN6000-15 subrack provides 20 vertical slots and one horizontal slot.

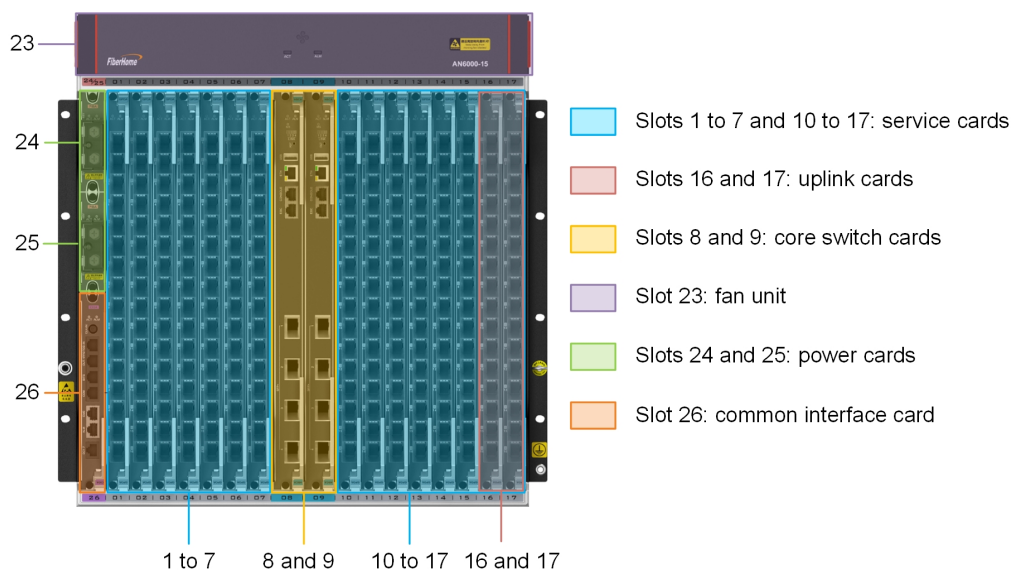

Card Supported

The slots can be classified as follows according to the cards they house:

Type	Slot	Card Supported
Service card slot	1 to 7, 10 to 17	GPOA, EX8A, EXOA, GX8A, GM8A, GMOA and GNOA
Uplink card slot	16 and 17	HU8A
Core switch card slot	8 and 9	HSCA
Fan unit slot	23	FAN
Power card slot	24 and 25	PIBA
Common interface card slot	26	CIOA

2.2.3 AN6000-7

Providing seven service slots, the AN6000-7 is a medium-sized optical line terminal device deployed in a central office. It can be applied to access scenarios with moderate density to help save the deployment cost of users.

Appearance and Structure

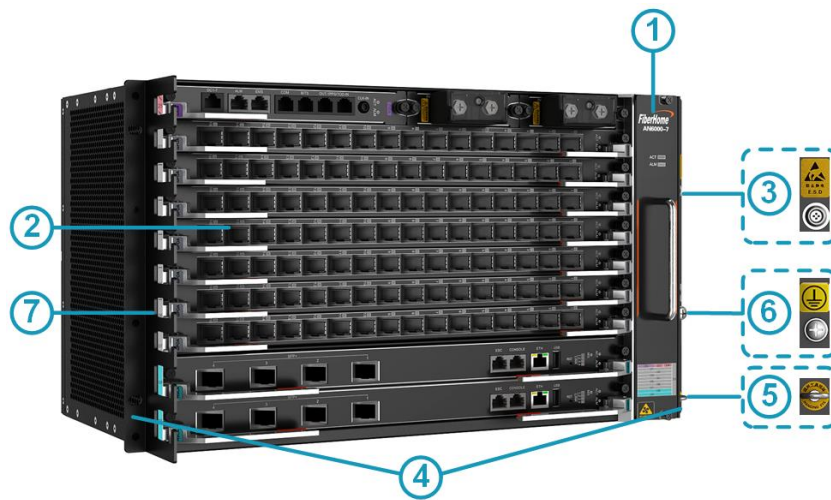

No.	Name	Function
①	Vertical card slot	Houses the fan unit.
②	Horizontal card slot	Accommodates cards to implement various functions of the equipment.
③	ESD protection earth ground fastener	Connects to the ESD protection device.
④	Mounting ear	Secures the subrack in the cabinet.
⑤	Fiber puller hanger	Holds the fiber puller.
⑥	Subrack earth ground point	Connects to the subrack protection earth ground cable.
⑦	Fiber passage unit	Facilitates routing and arranging of fibers and cables.

Slot Distribution

The AN6000-7 subrack provides 12 horizontal slots and one vertical slot.

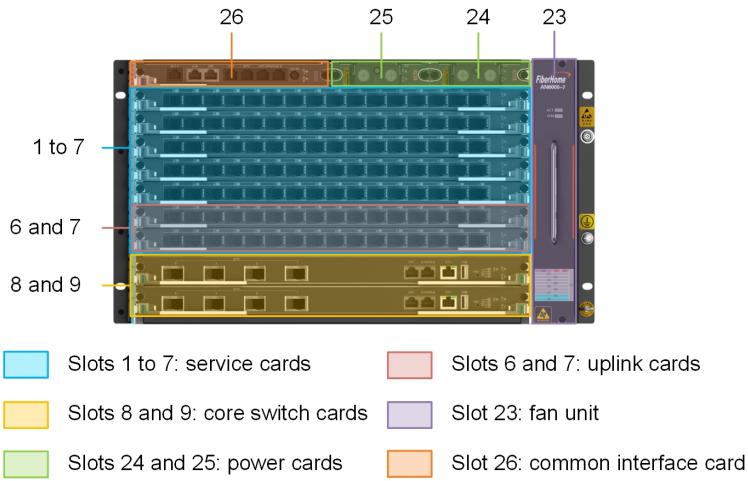

Card Supported

The slots can be classified as follows according to the cards they house:

Type	Slot	Card Supported
Service card slot	1 to 7	GPOA, EX8A, EXOA, GX8A, GM8A, GMOA and GNOA
Uplink card slot	6 and 7	HU8A
Core switch card slot	8 and 9	HSCA
Fan unit slot	23	FAN
Power card slot	24 and 25	PIBA
Common interface card slot	26	CIOA

2.3 Matching PDPs

The AN6000 Series support multiple PDPs. Users can choose an appropriate one according to their demand for power supplies. The table below describes the models, appearance, and input / output specifications of the PDPs.

Item	PDP850A		PDP463A	
	3000064-1FH	3000064-2FH	3000064-1FN	3000064-2FN
Appearance				

Item	PDP850A		PDP463A	
	AN6000-15 AN6000-7	AN6000-17 AN6000-15 AN6000-7	AN6000-15 AN6000-7	AN6000-17 AN6000-15 AN6000-7
Subracks supported	AN6000-15 AN6000-7	AN6000-17 AN6000-15 AN6000-7	AN6000-15 AN6000-7	AN6000-17 AN6000-15 AN6000-7
Range of input voltage	-38 V to -60 V	-38 V to -60 V	-38 V to -60 V	-38 V to -60 V
Number of input channels	Eight (four active and four standby)	Eight (four active and four standby)	Four (two active and two standby)	Four (two active and two standby)
Input current	The maximum current of a single channel is 63 A.	The maximum current of a single channel is 63 A.	The maximum current of a single channel is 63 A.	The maximum current of a single channel is 63 A.
Output voltage range	-38 V to -60 V	-38 V to -60 V	-38 V to -60 V	-38 V to -60 V
Number of output channels	Eight	Eight	Four	Four
Output current	The maximum current of a single channel is 63 A.	The maximum current of a single channel is 63 A.	The maximum current of a single channel is 63 A.	The maximum current of a single channel is 63 A.

2.4 Matching Cabinet

Table 2-1 shows the model numbers and appearances of the cabinets supported by the AN6000 Series, and Table 2-2 describes the dimensions and weight of the cabinets.

Table 2-1 Models and Appearances of the Cabinets

Cabinet Model	4102596 to 4102599	404000068 to 404000071	404000596 to 404000599	4102581 to 4102584
Description	19-inch 600 mm-deep cabinet with anti-dust screen	21-inch 300 mm-deep cabinet with anti-dust screen	21-inch 340 mm-deep cabinet with anti-dust screen	21-inch 600 mm-deep cabinet with anti-dust screen

Table 2-1 Models and Appearances of the Cabinets (Continued)

Subracks Supported	AN6000-15 AN6000-7	AN6000-17 AN6000-15 AN6000-7	AN6000-17 AN6000-15 AN6000-7	AN6000-17 AN6000-15 AN6000-7
Appearance				

Table 2-2 Dimensions and Weight of the Cabinets

Cabinet Type	Cabinet Model	Dimensions (H × W × D) (mm)	Weight (kg)
19-inch 600 mm-deep cabinet with anti-dust screen	4102596	1600 × 600 × 600	94
	4102597	2000 × 600 × 600	109
	4102598	2200 × 600 × 600	117
	4102599	2600 × 600 × 600	134
21-inch 300 mm-deep cabinet with anti-dust screen	404000068	1600 × 600 × 300	58
	404000069	2000 × 600 × 300	69
	404000070 ^{Note 1}	2200 × 600 × 300	74
	404000071	2600 × 600 × 300	85
21-inch 340 mm-deep cabinet with anti-dust screen	404000599	1600 × 600 × 340	51
	404000598	2000 × 600 × 340	63
	404000597	2200 × 600 × 340	70
	404000596	2600 × 600 × 340	81
21-inch 600 mm-deep cabinet with anti-dust screen	4102584	1600 × 600 × 600	79
	4102583	2000 × 600 × 600	89
	4102582	2200 × 600 × 600	99
	4102581	2600 × 600 × 600	109
Note 1: The AN6000-17 uses the 404000070 cabinet by default. In some special cases, cabinets of other heights can be used.			

3 Product Highlights

This chapter introduces the highlights of the AN6000 Series.

- Smooth Evolution to the Next-Generation PON
- Service Processing Capability
- Integrated Access to Multiple PONs
- Network Slicing Technology
- VXLAN Technology
- Environmentally-Friendly Design
- HQoS

3.1 Smooth Evolution to the Next-Generation PON

Evolution Benefits

EPON and GPON are mature PON technologies used in the current network. As the next-generation PON access technologies, 10G EPON, XG-PON and XGS-PON bring about higher bandwidth and enhanced capacity at the central office end. This helps lower the average cost of operators in line deployment and brings them more profit.

Table 3-1 Comparison Between PON Technologies in Bandwidth and Capacity

PON Technology	Uplink / Downlink Bandwidth (bit/s)	Maximum Split Ratio
EPON	1.25G / 1.25G	1:64
10G EPON	10G / 10G (symmetric) 1.25G / 10G (asymmetric)	1:128
GPON	1.25G / 2.5G	1:128
XG-PON	2.5G / 10G	1:256
XGS-PON	10G / 10G	1:256

Evolution Scheme

The AN6000 Series support various access standards, and can be evolved smoothly from the current PON networks to the next-generation ones. Multiple services including EPON, GPON, 10G EPON, XG-PON and XGS-PON services can be accessed via the same subrack. Currently, there are three major evolution schemes.

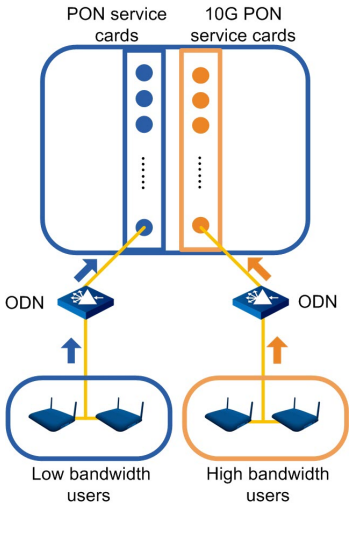
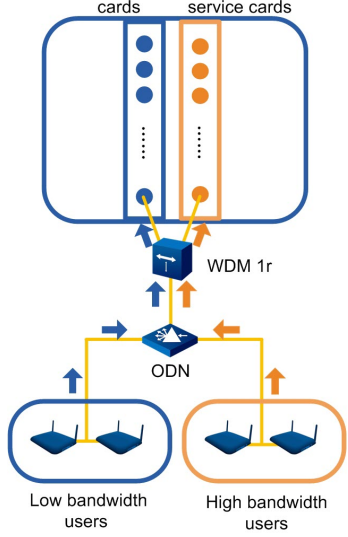
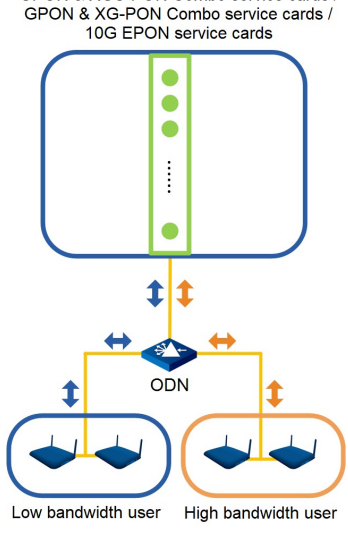
Item	Independent Deployment Scheme	Hybrid Deployment Scheme (WDM)	Hybrid Deployment Scheme (Combo PON)
Network diagram	 <p>PON service cards 10G PON service cards</p> <p>ODN ODN</p> <p>Low bandwidth users High bandwidth users</p>	 <p>PON service cards 10G PON service cards</p> <p>WDM 1r</p> <p>ODN</p> <p>Low bandwidth users High bandwidth users</p>	 <p>GPON & XGS-PON Combo service cards / GPON & XG-PON Combo service cards / 10G EPON service cards</p> <p>ODN</p> <p>Low bandwidth user High bandwidth user</p>
Scheme description	<p>The 1G PON and 10G PON subscribers are accessed via different service cards. The two subscriber groups share the same subrack, but do not share the backbone fiber. In this scheme, an independent service slot and an independent backbone fiber are required for the 10G PON subscribers. The operation is easy, and will not affect the services of existing subscribers.</p>	<p>The 1G PON and 10G PON subscribers are accessed via different service cards. The two subscriber groups share the same subrack. By virtue of the WDM technology, optical signals with different wavelengths are modulated and transmitted over the same backbone fiber. In this scheme, a WDM 1r device is required, which will cause an extra optical power loss (about 1.5 dB) on the link. Besides that, migration of existing subscriber services may also introduce a risk of service interruption.</p>	<p>The 1G PON and 10G PON subscribers can be accessed via the GPON & XGS-PON Combo service card, GPON & XG-PON Combo service card or 10G EPON service card. The operators can manage the two subscriber groups at the same time and use fewer service slots and backbone fibers to enable smooth evolution.</p>

3.2 Service Processing Capability

The AN6000 Series are designed with a high-performance backplane, and provide slots with high bandwidth. A high-rate backplane with good service processing capability is a key supporting technology to meet the access demand of the next-generation PON.

- ◆ The backplane capacity is up to 13.6 Tbit/s.
- ◆ The maximum slot bandwidth is 200 Gbit/s.
- ◆ Multiple access service cards such as EPON, GPON, 10G EPON, XG-PON, XGS-PON and P2P service cards can be applied to the same subrack.
- ◆ Scalable service processing capability is provided based on the programmable network processor (NP).

3.3 Integrated Access to Multiple PONs

The AN6000 Series support integrated connection to various PON services, including EPON, GPON, 10G EPON, XG-PON, XGS-PON, GPON & XG-PON Combo and GPON & XGS-PON Combo services, so as to cater for various service scenarios such as home access, enterprise access, and mobile fronthaul.

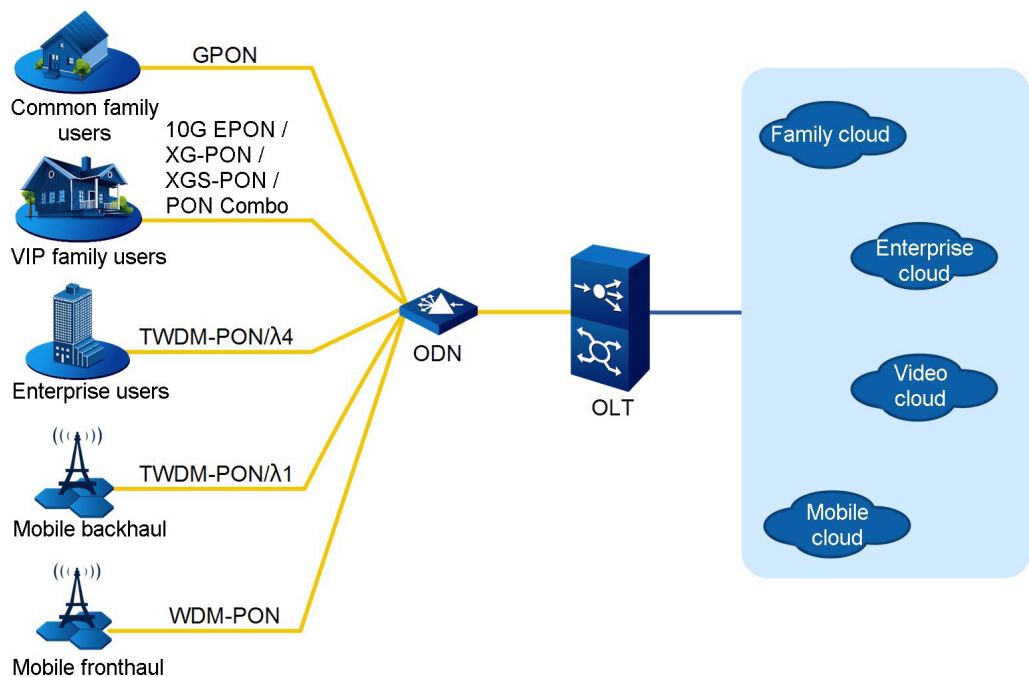

3.4 Network Slicing Technology

The network slicing technology is used to divide a physical OLT into multiple logical slices to achieve virtualization of the access network.

- ◆ The slicing technology helps achieve unified bearing and demand-based classification of services. That is, a physical network is divided into several virtual access networks to carry different services.
- ◆ The forwarding and control resources are virtualized, and each slice has unique access to these resources to ensure forwarding security and enhance reliability of private line services.
- ◆ The virtual access networks are managed based on authorization and domain division. Each slice is independently planned, operated and managed, with easier maintenance.
- ◆ The slice resources can be flexibly configured. Slicing based on cards, PON ports, ONUs or combination of them is supported.

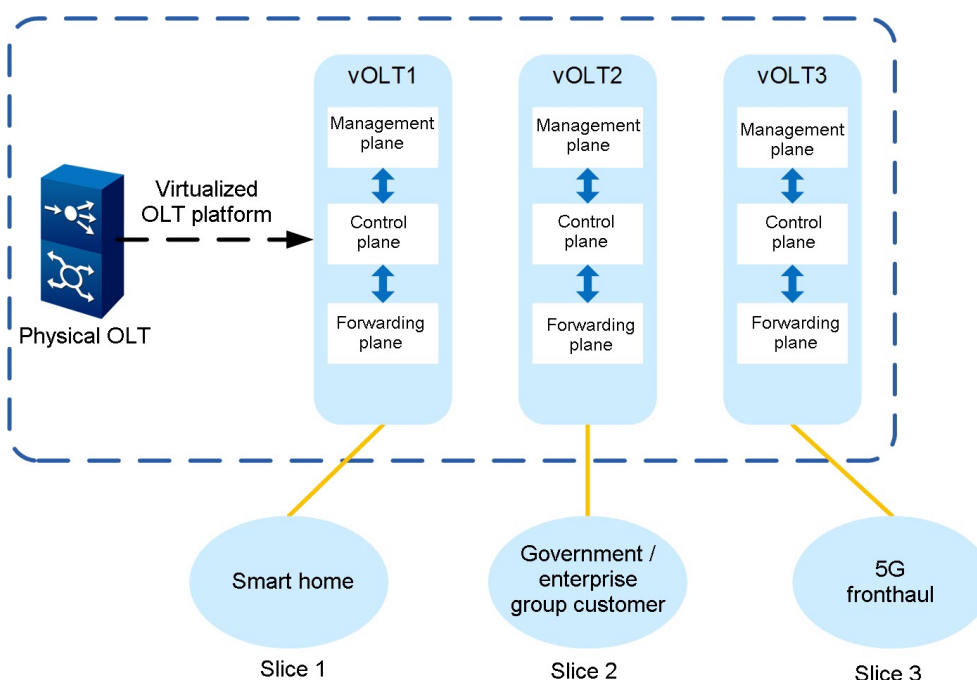

3.5 VXLAN Technology

VXLAN is a tunnel technology using MAC-in-UDP encapsulation.

- ◆ Supports up to 16384 VXLAN segments for network isolation, which are far more than the 4096 virtual network identifiers supported by VLAN. The bottleneck on user isolation and identifiers is removed, and a large number of tenants can be supported.
- ◆ When VXLAN encapsulation is used, only edge devices in the VXLAN need to identify MAC addresses on the user side. This relieves the MAC address learning pressure on other devices and improves their performance.
- ◆ Extends Layer 2 networks by using MAC-in-UDP encapsulation, and decouples physical and virtual networks. This facilitates configuration and migration of virtual machines on the user side.
- ◆ Supports static configuration or dynamic learning of the opposite-end VTEP.
- ◆ Supports flexible definition or remapping of service priorities.
- ◆ Supports flexible tunnel mappings (mappings to VNIs based on PON service cards, PON ports, ONUs and slices). The service scenarios using the aforesaid four mappings are described as follows:

▶ Mapping PON service cards to VNIs

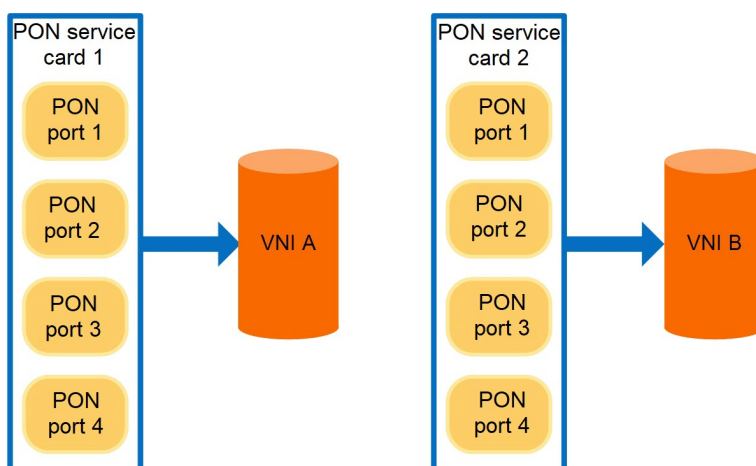

▶ Mapping PON ports to VNIs

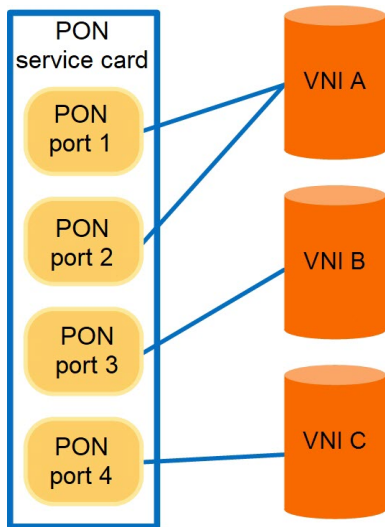

► Mapping ONUs to VNIs

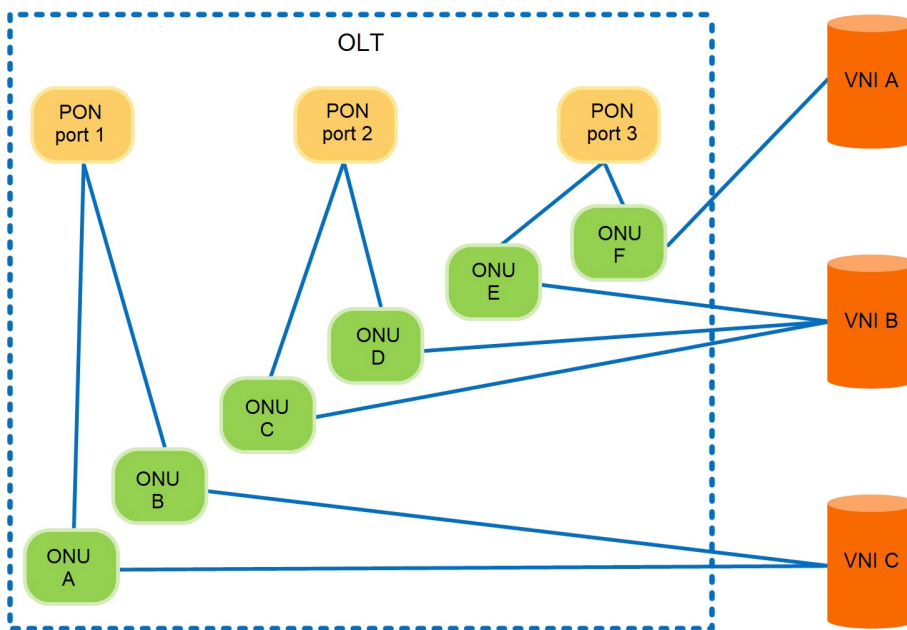

► Mapping slices to VNIs

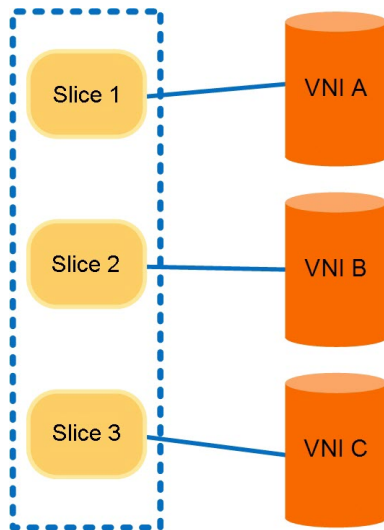

3.6 Environmentally-Friendly Design

The AN6000 Series conform to the energy efficiency standards in the industry. The concept of environment protection has been embraced in the product design to optimize the product performance in energy consumption, noise emission and heat dissipation, reduce environment pollution, and lower operation expenses.

The energy-saving design for the AN6000 Series is implemented in the following aspects:

- ◆ Passive optical network transmission technology featured by high split ratio, large capacity and high density is used to reduce consumption of power and optical fibers.
- ◆ Advanced lead-free production technology conforming to the RoHS2.0 standard is used.
- ◆ Chips with high performance and low power consumption are used. Accordingly, the overall power consumption of the equipment is lower than the average level in the industry.
- ◆ Intelligent temperature control fans are used to save energy and reduce noise.

3.7 HQoS

Hierarchical Quality of Service (HQoS) is a technology to ensure bandwidth for multiple users and services using a hierarchical scheduling mechanism.

- ◆ Supports unified management and hierarchical scheduling for multiple users and services to ensure the bandwidth for user services.
- ◆ Supports hierarchical scheduling based on services, ONUs and PON ports (while the traditional QoS services can only be scheduled based on ports) so that operators can guarantee the QoS for different user services, providing assured bandwidth and services for more users and making more benefits.

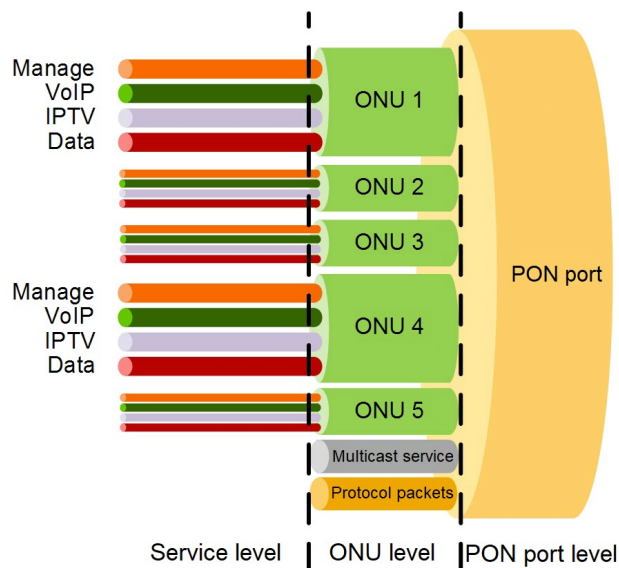

4 Product Specification

This chapter introduces the main specifications of the AN6000 Series and the grounding requirements for the equipment room / outdoor cabinet environment.

- AN6000-17
- AN6000-15
- AN6000-7
- Environment and Grounding Requirements for Equipment Rooms / Outdoor Cabinets

4.1 AN6000-17

Item	Specification
Slot configuration	Two slots for core switch cards (slots 9 and 10) 17 slots for service cards (slots 1 to 8 and 11 to 19) Two slots for uplink cards (slots 18 and 19) Two slots for power cards (slots 24 and 25) One slot for the common interface card (slot 26) One slot for the fan unit (slot 23)
Dimensions of a subrack with mounting ears for 21-inch cabinets (H × W × D) ^{Note 1}	486 mm × 530 mm × 282 mm
Weight of an empty subrack (excluding the fan unit)	14 kg
Weight of an empty subrack (including the fan unit)	19 kg
Maximum input current	63 A
Power supply mode	DC (two channels of power supplies forming redundancy protection)
Working voltage range	-38.4 V to -57.6 V
Rated voltage	-48 V
Working temperature	-40°C to 65°C
Working relative humidity	5% to 95% (non-condensing)
Storage temperature	-40°C to 70°C
Relative humidity for storage	5% to 95% (non-condensing)
Atmospheric pressure	70 kPa to 106 kPa
Slot bandwidth	200 Gbit/s
Switching capacity of the backplane bus	13.6 Tbit/s
Core switch card capacity (in the load sharing mode)	6.8 Tbit/s
System Layer 2 forwarding rate (in the load sharing mode)	2400 M/s
Maximum number of MAC addresses in the system	262144
Maximum number of IPv4 routing tables in the system	16384
Maximum number of IPv6 routing tables in the system	8192
Maximum number of ARP tables in the system	18432
Maximum number of ND tables in the system	9216
Maximum number of multicast groups in the system	4096
Full-load bit error rate	< 10 e ⁻⁷

Item	Specification
System reliability specifications	System availability with typical configuration: > 99.999% Mean time between failures (MTBF) of the system: approx. 45 years Note: The mean time to repair (MTTR) for the entire system is 2 hours.
Maximum number of GPON ports in the system	272
Maximum number of 10G EPON ports in the system	272
Maximum number of XG-PON ports in the system	272
Maximum number of GPON & XG-PON Combo ports in the system	272
Maximum number of GPON & XGS-PON Combo ports in the system	272
Maximum number of uplink ports in the system	Eight 10GE / GE uplink ports (HSCA) (Only core switch cards are used to provide uplink ports.)
	Sixteen 10GE / GE uplink ports (HU8A) + eight 10GE / GE uplink ports (HSCA) (Both core switch cards and uplink cards are used to provide uplink ports.)
Maximum number of ONUs connected to the system	17408
Maximum number of multicast users in the system	17408
Maximum transmission distance (PON port)	60 km
Maximum uplink transmission distance	80 km
Delay in system switching and forwarding	0.64 us to 1.68 us (the packet size ranging from 64 bytes to 1518 bytes)
Time for active-standby switching of core switch cards / uplink cards	≤ 50 ms
Time for optical path protection switching (Type B / Type C)	≤ 50 ms
Bandwidth allocation granularity of DBA	GPOA: 64 kbit/s
	EX8A: 640 kbit/s
	EXO: 640 kbit/s
	GX8A: 256 kbit/s
	GM8A: 256 kbit/s (XG-PON) / 64 kbit/s (GPON)
	GMOA: 256 kbit/s (XG-PON) / 64 kbit/s (GPON)
Minimum configurable bandwidth of DBA	GNOA: 1024 kbit/s (XGS-PON) / 64 kbit/s (GPON)
	GPOA: 1024 kbit/s
	EX8A: 2560 kbit/s
	EXO: 2560 kbit/s

Item	Specification
	GX8A: 1024 kbit/s
	GM8A: 1024 kbit/s
	GMOA: 1024 kbit/s
	GNOA: 1024 kbit/s
DBA accuracy	Better than $\pm 5\%$
Long-term packet loss rate	When the traffic accounts for 90% of the throughput, the 24-hour packet loss rate is 0.
Overall power consumption	<p>Typical configuration: 2 × HSCA + 17 × GPOA + 2 × PIBA + FAN + CIOA</p> <ul style="list-style-type: none"> ◆ Static power consumption: 888 W ◆ Typical power consumption: 954 W ◆ Maximum power consumption: 1208 W <p>The overall power consumption is measured under the following conditions:</p> <ul style="list-style-type: none"> ◆ Working voltage: -53.5 V DC. ◆ Room temperature: 25°C (static power consumption and typical power consumption), 55°C (maximum power consumption) ◆ Static power consumption: All the broadband ports are deactivated. ◆ Typical power consumption: 50% of the broadband ports are concurrently activated. ◆ Maximum power consumption: 100% of the broadband ports are concurrently activated.
Note 1: The AN6000-17 subrack is equipped with the mounting ears for 21-inch cabinets by default.	

4.2 AN6000-15

Item	Specification
Slot configuration	<p>Two slots for core switch cards (slots 8 and 9)</p> <p>15 slots for service cards (slots 1 to 7 and 10 to 17)</p> <p>Two slots for uplink cards (slots 16 and 17)</p> <p>Two slots for power cards (slots 24 and 25)</p> <p>One slot for the common interface card (slot 26)</p> <p>One slot for the fan unit (slot 23)</p>
Dimensions of a subrack with mounting ears for 19-inch cabinets (H × W × D) ^{Note 1}	486 mm × 480 mm × 282 mm
Dimensions of a subrack with mounting ears for 21-inch cabinets (H × W × D)	486 mm × 530 mm × 282 mm

Item	Specification
Weight of an empty subrack (excluding the fan unit)	12.15 kg
Weight of an empty subrack (including the fan unit)	16.65 kg
Maximum input current	63 A
Power supply mode	DC (two channels of power supplies forming redundancy protection)
Working voltage range	-38.4 V to -57.6 V
Rated voltage	-48 V
Working temperature	-40°C to 65°C
Working relative humidity	5% to 95% (non-condensing)
Storage temperature	-40°C to 70°C
Relative humidity for storage	5% to 95% (non-condensing)
Atmospheric pressure	70 kPa to 106 kPa
Slot bandwidth	200 Gbit/s
Switching capacity of the backplane bus	12 Tbit/s
Core switch card capacity (in the load sharing mode)	6.8 Tbit/s
System Layer 2 forwarding rate (in the load sharing mode)	2400 M/s
Maximum number of MAC addresses in the system	262144
Maximum number of IPv4 routing tables in the system	16384
Maximum number of IPv6 routing tables in the system	8192
Maximum number of ARP tables in the system	18432
Maximum number of ND tables in the system	9216
Maximum number of multicast groups in the system	4096
Full-load bit error rate	$< 10 e^{-7}$
System reliability specifications	System availability with typical configuration: > 99.999% MTBF of the system: approx. 45 years Note: The MTTR for the entire system is 2 hours.
Maximum number of GPON ports in the system	240
Maximum number of 10G EPON ports in the system	240
Maximum number of XG-PON ports in the system	240
Maximum number of GPON & XG-PON Combo ports in the system	240
Maximum number of GPON & XGS-PON Combo ports in the system	240
Maximum number of uplink ports in the system	Eight 10GE / GE uplink ports (HSCA) (Only core switch cards are used to provide uplink ports.)

Item	Specification
	Sixteen 10GE / GE uplink ports (HU8A) + eight 10GE / GE uplink ports (HSCA) (Both core switch cards and uplink cards are used to provide uplink ports.)
Maximum number of ONUs connected to the system	17408
Maximum number of multicast users in the system	17408
Maximum transmission distance (PON port)	60 km
Maximum uplink transmission distance	80 km
Delay in system switching and forwarding	0.64 us to 1.68 us (the packet size ranging from 64 bytes to 1518 bytes)
Time for active-standby switching of core switch cards / uplink cards	≤ 50 ms
Time for optical path protection switching (Type B / Type C)	≤ 50 ms
Bandwidth allocation granularity of DBA	GPOA: 64 kbit/s
	EX8A: 640 kbit/s
	EXOA: 640 kbit/s
	GX8A: 256 kbit/s
	GM8A: 256 kbit/s (XG-PON) / 64 kbit/s (GPON)
	GMOA: 256 kbit/s (XG-PON) / 64 kbit/s (GPON)
	GNOA: 1024 kbit/s (XGS-PON) / 64 kbit/s (GPON)
Minimum configurable bandwidth of DBA	GPOA: 1024 kbit/s
	EX8A: 2560 kbit/s
	EXOA: 2560 kbit/s
	GX8A: 1024 kbit/s
	GM8A: 1024 kbit/s
	GMOA: 1024 kbit/s
	GNOA: 1024 kbit/s
DBA accuracy	Better than ±5%
Long-term packet loss rate	When the traffic accounts for 90% of the throughput, the 24-hour packet loss rate is 0.

Item	Specification
Overall power consumption	<p>Typical configuration: 2 × HSCA + 15 × GPOA + 2 × PIBA + FAN + CIOA</p> <ul style="list-style-type: none"> ◆ Static power consumption: 813 W ◆ Typical power consumption: 875 W ◆ Maximum power consumption: 1340 W <p>The overall power consumption is measured under the following conditions:</p> <ul style="list-style-type: none"> ◆ Working voltage: -53.5 V DC. ◆ Room temperature: 25°C (static power consumption and typical power consumption), 55°C (maximum power consumption) ◆ Static power consumption: All the broadband ports are deactivated. ◆ Typical power consumption: 50% of the broadband ports are concurrently activated. ◆ Maximum power consumption: 100% of the broadband ports are concurrently activated.
Note 1: The AN6000-15 subrack is equipped with the mounting ears for 19-inch cabinets by default.	

4.3 AN6000-7

Item	Specification
Slot configuration	<p>Two slots for core switch cards (slots 8 and 9)</p> <p>Seven slots for service cards (slots 1 to 7)</p> <p>Two slots for uplink cards (slots 6 and 7)</p> <p>Two slots for power cards (slots 24 and 25)</p> <p>One slot for the common interface card (slot 26)</p> <p>One slot for the fan unit (slot 23)</p>
Dimensions of a subrack with mounting ears for 19-inch cabinets (H × W × D) ^{Note 1}	266 mm × 480 mm × 253.8 mm (excluding the fiber passage unit)
Dimensions of a subrack with mounting ears for 21-inch cabinets (H × W × D)	266 mm × 530 mm × 253.8 mm (excluding the fiber passage unit)
Weight of an empty subrack (excluding the fan unit)	8.5 kg
Weight of an empty subrack (including the fan unit)	10.7 kg
Maximum input current	37.5 A
Power supply mode	DC (two channels of power supplies forming redundancy protection)
Working voltage range	-38.4 V to -57.6 V
Rated voltage	-48 V

Item	Specification
Working temperature	-40°C to 65°C
Working relative humidity	5% to 95% (non-condensing)
Storage temperature	-40°C to 70°C
Relative humidity for storage	5% to 95% (non-condensing)
Atmospheric pressure	70 kPa to 106 kPa
Slot bandwidth	200 Gbit/s
Switching capacity of the backplane bus	5.6 Tbit/s
Core switch card capacity (in the load sharing mode)	6.8 Tbit/s
System Layer 2 forwarding rate (in the load sharing mode)	2400 M/s
Maximum number of MAC addresses in the system	262144
Maximum number of IPv4 routing tables in the system	16384
Maximum number of IPv6 routing tables in the system	8192
Maximum number of ARP tables in the system	18432
Maximum number of ND tables in the system	9216
Maximum number of multicast groups in the system	4096
Full-load bit error rate	$< 10 e^{-7}$
System reliability specifications	System availability with typical configuration: > 99.999% MTBF of the system: approx. 45 years Note: The MTTR for the entire system is 2 hours.
Maximum number of GPON ports in the system	112
Maximum number of 10G EPON ports in the system	112
Maximum number of XG-PON ports in the system	112
Maximum number of GPON & XG-PON Combo ports in the system	112
Maximum number of GPON & XGS-PON Combo ports in the system	112
Maximum number of uplink ports in the system	Eight 10GE / GE uplink ports (HSCA) (Only core switch cards are used to provide uplink ports.)
	Sixteen 10GE / GE uplink ports (HU8A) + eight 10GE / GE uplink ports (HSCA) (Both core switch cards and uplink cards are used to provide uplink ports.)
Maximum number of ONUs connected to the system	8192
Maximum number of multicast users in the system	8192
Maximum transmission distance (PON port)	60 km
Maximum uplink transmission distance	80 km

Item	Specification
Delay in system switching and forwarding	0.64 us to 1.68 us (the packet size ranging from 64 bytes to 1518 bytes)
Time for active-standby switching of core switch cards / uplink cards	≤ 50 ms
Time for optical path protection switching (Type B / Type C)	≤ 50 ms
Bandwidth allocation granularity of DBA	GPOA: 64 kbit/s
	EX8A: 640 kbit/s
	EXOA: 640 kbit/s
	GX8A: 256 kbit/s
	GM8A: 256 kbit/s (XG-PON) / 64 kbit/s (GPON)
	GMOA: 256 kbit/s (XG-PON) / 64 kbit/s (GPON)
	GNOA: 1024 kbit/s (XGS-PON) / 64 kbit/s (GPON)
Minimum configurable bandwidth of DBA	GPOA: 1024 kbit/s
	EX8A: 2560 kbit/s
	EXOA: 2560 kbit/s
	GX8A: 1024 kbit/s
	GM8A: 1024 kbit/s
	GMOA: 1024 kbit/s
	GNOA: 1024 kbit/s
DBA accuracy	Better than ±5%
Long-term packet loss rate	When the traffic accounts for 90% of the throughput, the 24-hour packet loss rate is 0.

Item	Specification
Overall power consumption	<p>Typical configuration: 2 × HSCA + 7 × GPOA + 2 × PIBA + FAN + CIOA</p> <ul style="list-style-type: none"> ◆ Static power consumption: 481 W ◆ Typical power consumption: 527 W ◆ Maximum power consumption: 790 W <p>The overall power consumption is measured under the following conditions:</p> <ul style="list-style-type: none"> ◆ Working voltage: -53.5 V DC. ◆ Room temperature: 25°C (static power consumption and typical power consumption), 55°C (maximum power consumption) ◆ Static power consumption: All the broadband ports are deactivated. ◆ Typical power consumption: 50% of the broadband ports are concurrently activated. ◆ Maximum power consumption: 100% of the broadband ports are concurrently activated.
MTU size	9000
Note 1: The AN6000-7 subrack is equipped with the mounting ears for 19-inch cabinets by default.	

4.4 Environment and Grounding Requirements for Equipment Rooms / Outdoor Cabinets

Requirements for Operating Environment

Item	Requirement
Bearing capacity of the floor in the equipment room	> 600 kg/m ²
Ambient air quality	No corrosive and solvent gas, and no dust; no strong electromagnetic fields nearby.
Concentration of mechanical active substances	Suspended dust: ≤ 0.4 mg/m ³
	Deposited dust: ≤ 15 mg/(m ² ·h)
	Gravel: ≤ 300 mg/m ³
Concentration of chemical substances	SO ₂ ≤ 0.30 mg/m ³
	H ₂ S ≤ 0.10 mg/m ³
	NO _x ≤ 0.50 mg/m ³
	NH ₃ ≤ 1.00 mg/m ³
	Cl ₂ ≤ 0.10 mg/m ³

Item	Requirement
	HCl ≤ 0.10 mg/m ³
	HF ≤ 0.01 mg/m ³
	O ₃ ≤ 0.05 mg/m ³

Equipment Room / Outdoor Cabinet and Grounding Requirements

Grounding Parameter		Requirement
Outdoor cabinet	Earth ground flat steel or cable for the collective earth ground bar	Hot-dip galvanized flat steel: width ≥ 40 mm, thickness ≥ 4 mm Earth ground cable: 16 mm ²
	Earth ground cable for the equipment chassis	≥ 4 mm ²
	Earth ground cable for the optical cable reinforced core	≥ 4 mm ²
	Earth ground cable for the MDF	≥ 6 mm ²
	Grounding resistance	< 10Ω
Equipment room	Earth ground flat steel or cable for the collective lightning-proofing ground bar	Hot-dip galvanized flat steel: width ≥ 40 mm, thickness ≥ 4 mm Earth ground cable: ≥ 95 mm ²
	Earth ground cable for the optical cable reinforced core	16 mm ²
	Earth ground cable for the Class B AC surge protection device	≥ 16 mm ²
	Earth ground cable for the Class C surge protection device	≥ 16 mm ²
	Earth ground cable for the MDF	> 35 mm ²
	Earth ground cable for the subrack	4 mm ²
	Grounding resistance	< 10Ω

5 Product Function

This chapter introduces the main functions supported by the AN6000 Series.

- List of Functions and Features
- PON Access Function
- Layer 2 Function
- Voice Service Function
- Multicast Service Function
- Network Slicing Function
- VXLAN Function
- Layer 3 Function
- Time and Clock Synchronization Function
- QoS Function
- Reliability Function
- Security Function
- Maintenance and Management Function

5.1 List of Functions and Features

Classification		Function
ONU authentication and authorization management		Multiple ONU authentication modes, including authentication based on physical identifier, logical identifier (without password), physical identifier / logical identifier (without password), or password, and hybrid authentication based on physical identifier + physical password
Access feature	PON access function	EPON access
		GPON access
		10G EPON access
		XG-PON access
		GPON & XG-PON Combo access
		GPON & XGS-PON Combo access
	P2P access function	Ethernet P2P access, Ethernet cascade networking
Service function	Multicast function	IGMP V1 / V2 / V3
		IGMP Proxy / Snooping
		MLD V1 / V2
		MLD Proxy / Snooping
		Multicast VLAN
		Copying and broadcasting of multicast
		Multicast information statistics
	Voice function	VoIP voice service
		POTS voice service
		H.248 and SIP protocols
		PPPoE configuration
		DHCP configuration
		Query of NGN statistics information
		Query of NGN resource status
Voice intercommunication inside the PON		
VXLAN function	VXLAN L2 Gateway	
	Static configuration or dynamic learning of the opposite-end VTEP	
	Flexible definition or remapping of service priorities	
	Flexible tunnel mappings (mappings to VNIs based on slices, PON service cards, PON ports and ONUs)	
Network slicing function	Eight OLT slices	
	Service management based on authorization and domain and independent deployment of services	

Classification		Function
		Flexible configuration of slice resources and slicing based on cards, PON ports, ONUs or combination of them
		Sharing uplink ports based on VLAN and VXLAN IDs
Time and clock synchronization function		System internal clock
		BITS clock
		E1 line clock (GPS clock)
		1588v2 clock
		Adaptive clock recovery
		Synchronous Ethernet clock
Layer 2 function	VLAN function	802.1Q VLAN
		VLAN aggregation
		QinQ VLAN
		Selective QinQ (Stacking VLAN)
		VLAN translation
	Layer 2 forwarding strategy	VLAN + MAC forwarding
		SVLAN + CVLAN forwarding
	Layer 2 switching function	Independent learning of MAC addresses
		Shared learning of MAC addresses
		Clearing a Layer 2 forwarding table globally
Configuring the MAC address aging time for the OLT and ONU		
Layer 3 function	Layer 3 interface function	Creation and use of Super VLANs
	ARP Proxy function	ARP Proxy
	DHCP function	DHCP Relay, DHCP Snooping or DHCP Server
		Relay agent Option18 / Option37 function of DHCPv6
		DHCP Option82
		Isolating illegal DHCP server
	Routing function	Static routing
		OSPF
QoS function		Traffic classification
		Priority processing
		Traffic policing based on trTCM
		WRED
		Traffic shaping
		HQoS
		PQ, WRR, and PQ + WRR queue scheduling algorithms

Classification		Function
		IPv4/IPv6 QoS
		ACL
Maintenance and management function	Maintenance function	Ingress and egress mirroring and flow mirroring
		Flexible port mirroring (port mirroring based on PON ports and ONUs, and remote mirroring)
		Save and query of the performance statistics and historical data
		Remote upgrade of software
		Automatic rollback during software upgrade
		Synchronization of equipment configuration and EMS configuration
		License
	Network management function	SNMP
		SSH
		LLDP
		Telnet
		In-band management
		Out-of-band management
		Classification of operation authorities
		Remote operation and user management
		Log management
		Version and data management
		Exception handling for the equipment
		Reliability function
ERPS		
MSTP (IEEE 802.1s), RSTP (IEEE 802.1w) and STP (IEEE 802.1D)		
LACP intra-card and inter-card aggregation (IEEE 802.3ad)		
Trunk		
Service overload control		
Redundancy backup of core switch cards		
1+1 load sharing and forwarding		
Redundancy backup of uplink cards		
Redundancy backup of power cards		

5.2 PON Access Function

This section introduces the PON access functions supported by the equipment, including EPON, GPON, 10G EPON, XG-PON, XGS-PON and XG(S)-PON Combo access.

5.2.1 EPON Access Function

Basic Concept

Ethernet Passive Optical Network (EPON) is a long-haul Ethernet access technology based on the optical transmission network. Compliant with the IEEE 802.3ah standard, EPON uses the point-to-multipoint (P2MP) architecture and single-fiber WDM technology (the downlink central wavelength being 1490 nm, and the uplink central wavelength being 1310 nm) to implement bi-directional transmission over a single fiber.

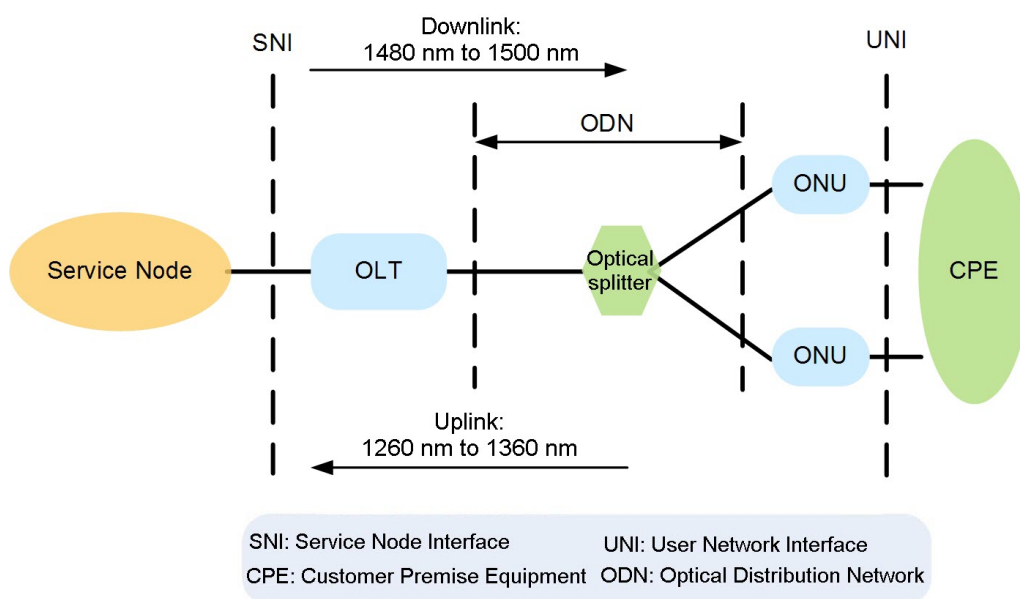

Application

As a mature PON technology, EPON features low cost, high bandwidth, good scalability, compatibility with existing Ethernet, and easy management. Accordingly, EPON is widely applied to carrier networks.

Advantages of EPON application:

- ◆ Low cost: The maintenance, extension and upgrading are easy with a low cost.
- ◆ High bandwidth: Currently, EPON can provide symmetric bandwidth up to 1.25 Gbit/s in both uplink and downlink directions. With the development of Ethernet technology, the bandwidth can be smoothly evolved to 10 Gbit/s.
- ◆ Flexible bandwidth allocation and assured service quality: A sound system is provided to guarantee bandwidth allocation. Queue scheduling mechanisms including differentiated services (DiffServ), priority queue (PQ) / weighted fair queuing (WFQ), and weighted random early detection (WRED) are applied to bandwidth allocation to ensure quality of services for each subscriber.

Network Diagram

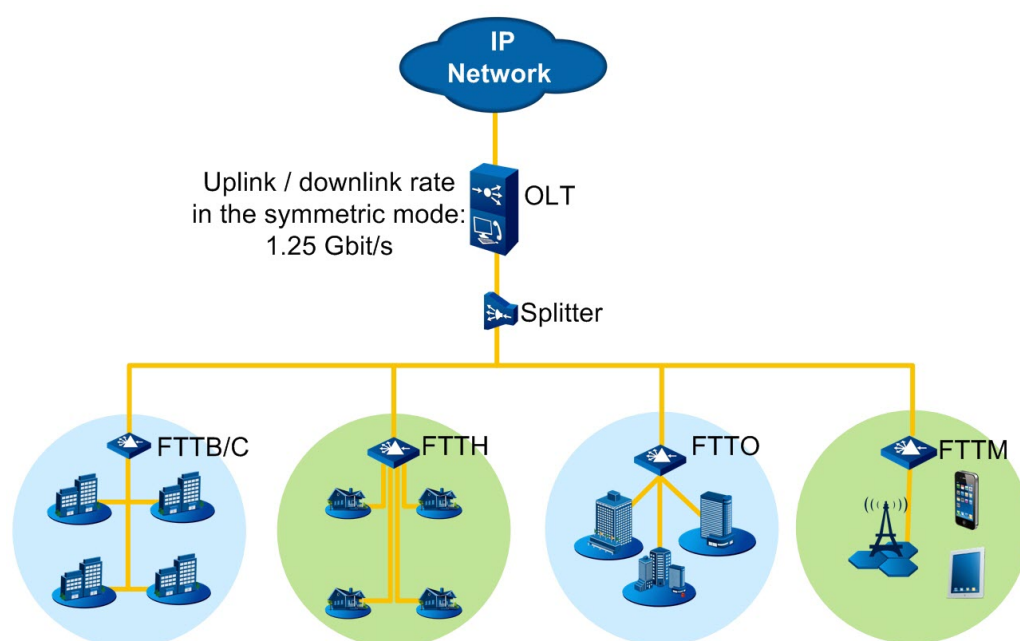

Highlight

- ◆ Abundant Layer 3 functions and features: Supports Super VLAN, ARP / ARP Proxy, and DHCP Relay; provides flexible ACL functions and abundant QoS functions.
- ◆ Provides abundant card security measures, including DHCP Option and PPPoE+.
- ◆ Supports IPv6.
- ◆ Supports redundancy protection for services, backbone fibers, and uplink ports.

- ◆ Provides clock and time synchronization with high precision. Uses the system time transfer protocol defined in IEEE 802.1as, and supports IEEE1588 V2.

Functions and Specifications

Function	Specification
Standard compliance	Supports EPON functions defined in IEEE 802.3-2008.
Transmission rate	Symmetric rates in the uplink and downlink directions: 1.25 Gbit/s
Wavelength	<ul style="list-style-type: none"> ◆ Uplink: 1260 nm to 1360 nm ◆ Downlink: 1480 nm to 1500 nm
Maximum transmission distance	60 km
Maximum differential fiber distance	40 km
Maximum split ratio	1:64
Detection of optical power	Supports the RSSI detection.
Detection of rogue ONUs	Supports automatic detection and location of ONUs that constantly emit light.
Compatibility	Supports various kinds of ONUs, such as SBU, SFU, MTU, cassette MDU, and MDU which can accommodate cards.
DBA function	Supports three bandwidth types: fixed bandwidth, assured bandwidth, and maximum bandwidth.
	Supports the dynamic bandwidth allocation (DBA) algorithm.
Reliability	Supports Type B, Type C and Type C dual-homing protections.
Throughput	Uplink throughput: ≥ 900 Mbit/s (packets with the size between 64 Bytes and 1518 Bytes are counted; the split ratio is 1:32)
	Downlink throughput: ≥ 950 Mbit/s (packets of all sizes are counted)
Transmission delay	When the split ratio is 1:32, the uplink average transmission delay (when the traffic is no more than 90% of the system throughput) is less than 1.5 ms (packets with the size between 64 Bytes and 1518 Bytes are counted).
	The downlink average transmission delay (when the traffic is no more than 90% of the system throughput) is less than 1 ms (packets of all sizes are counted).

5.2.2 GPON Access Function

Basic Concept

Gigabit Passive Optical Network (GPON) is a PON technology defined in ITU-T G.984 series of standards. The figure below shows the network structure of GPON.

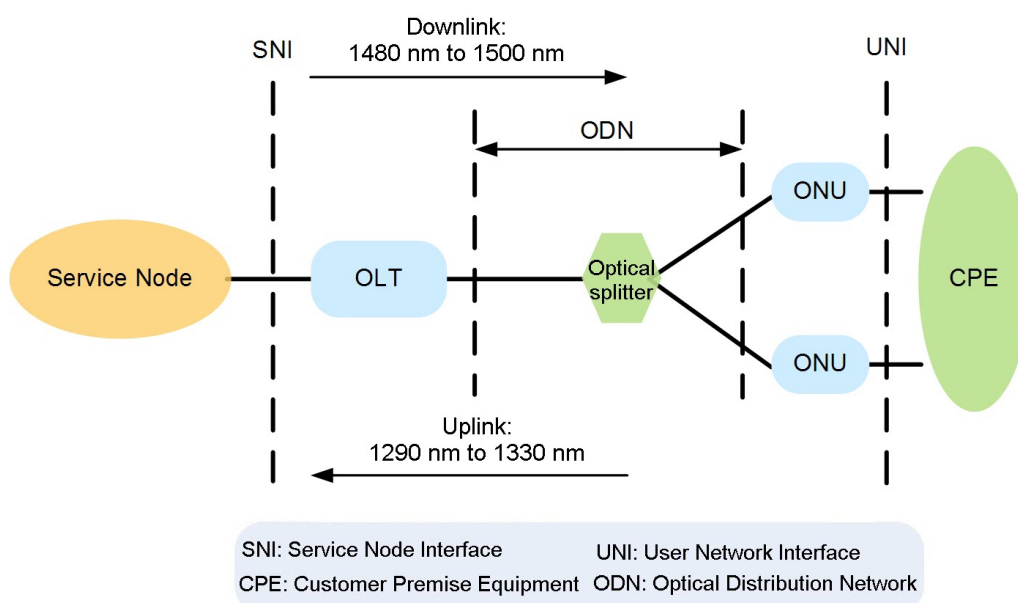

Application

The GPON access technology provides high-bandwidth transmission, overcomes the bandwidth bottleneck in twisted pair access, and caters to users' demand for high bandwidth services.

Advantages of GPON application:

- ◆ High density: Supports the split ratio of 1:128. The GPOA card can access up to 2048 subscribers.
- ◆ High bandwidth: GPON can provide a bandwidth of 1.25 Gbit/s in the uplink direction and 2.5 Gbit/s in the downlink direction. The bandwidth can be smoothly migrated to 10 Gbit/s.
- ◆ HQoS: Ensures that 4K-resolution video programs are not suspended in case of bandwidth congestion.
- ◆ FEC functions: Enhances fault tolerance of the system to ODN errors.

Network Diagram

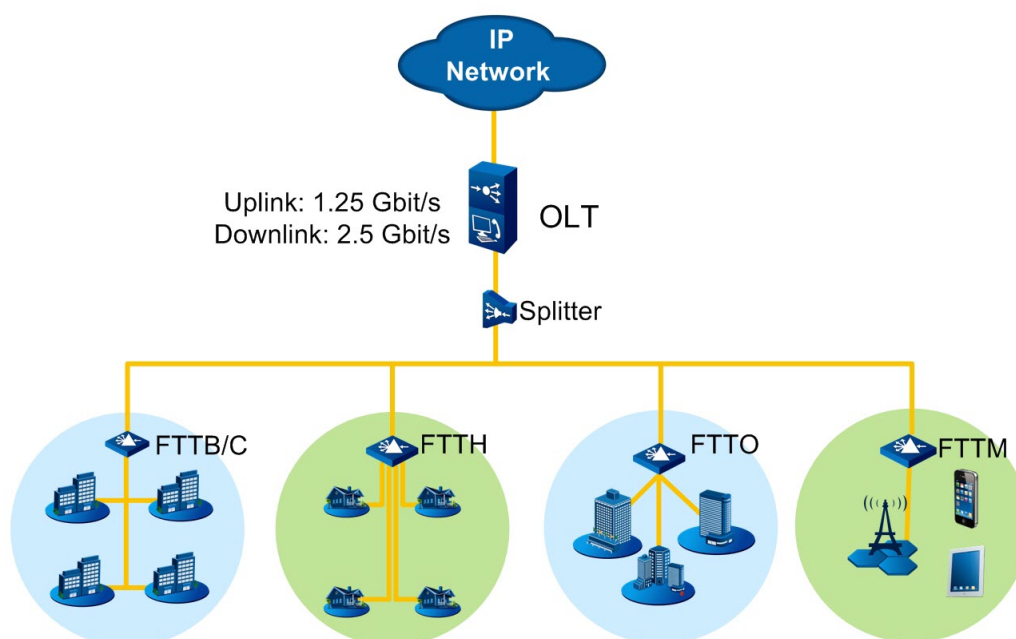

Highlight

- ◆ Supports Type B and Type C protections to ensure reliability of mobile backhaul services as well as government and enterprise customer services.
- ◆ Supports clock synchronization, and provides a low-cost solution for mobile backhaul services.
- ◆ Transmits data in an efficient way:
 - ▶ Encapsulates all the data to be transmitted into 125 us frames (fixed length frames) with the new GEM encapsulation structure, which uses fewer transmission overhead bytes and improves the transmission efficiency.
 - ▶ The transmission efficiency can reach 93% when the downlink rate is 2.5 Gbit/s and the uplink rate is 1.25 Gbit/s.
- ◆ Provides clock and time synchronization with high precision. Uses the system time transfer protocol defined in IEEE 802.1as, and supports IEEE1588 V2.

Functions and Specifications

Function	Specification
Standard compliance	Conforms to ITU-T G.984 series of standards, with good interoperability.
Transmission rate	<ul style="list-style-type: none"> ◆ Uplink: 1.25 Gbit/s ◆ Downlink: 2.5 Gbit/s
Wavelength	<ul style="list-style-type: none"> ◆ Uplink: 1290 nm to 1330 nm ◆ Downlink: 1480 nm to 1500 nm
Maximum transmission distance	60 km
Maximum differential fiber distance	40 km
Maximum split ratio	1:128
Detection of optical power	Supports the RSSI detection.
Detection of rogue ONUs	Supports automatic detection and location of ONUs that constantly emit light.
Compatibility	Supports various kinds of ONUs, such as SBU, SFU, MTU, cassette MDU, and MDU which can accommodate cards.
DBA function	Dynamically allocates bandwidth according to subscribers' traffic status.
Reliability	Supports Type B, Type C and Type C dual-homing protections.
Throughput	Uplink throughput: ≥ 1100 Mbit/s
	Downlink throughput: ≥ 2400 Mbit/s
Transmission delay	When the split ratio is 1:32, the uplink average transmission delay (when the traffic is no more than 90% of the system throughput) is less than 1.5 ms (packets with the size between 64 Bytes and 1518 Bytes are counted).
	The downlink average transmission delay (when the traffic is no more than 90% of the system throughput) is less than 1 ms (packets of all sizes are counted).

5.2.3 10G EPON Access Function

Basic Concept

10G EPON is a point-to-multipoint passive optical network access technology standardized in IEEE 802.3av, which is evolved from the EPON standard IEEE 802.3ah. There are two key points in the IEEE 802.3av standard: the uplink and downlink bandwidths specified in IEEE 802.3ah are raised up to 10 Gbit/s; 10G EPON has good compatibility so that 10G EPON ONUs can coexist with EPON ONUs in an ODN. In this way, the operator's investment is protected.

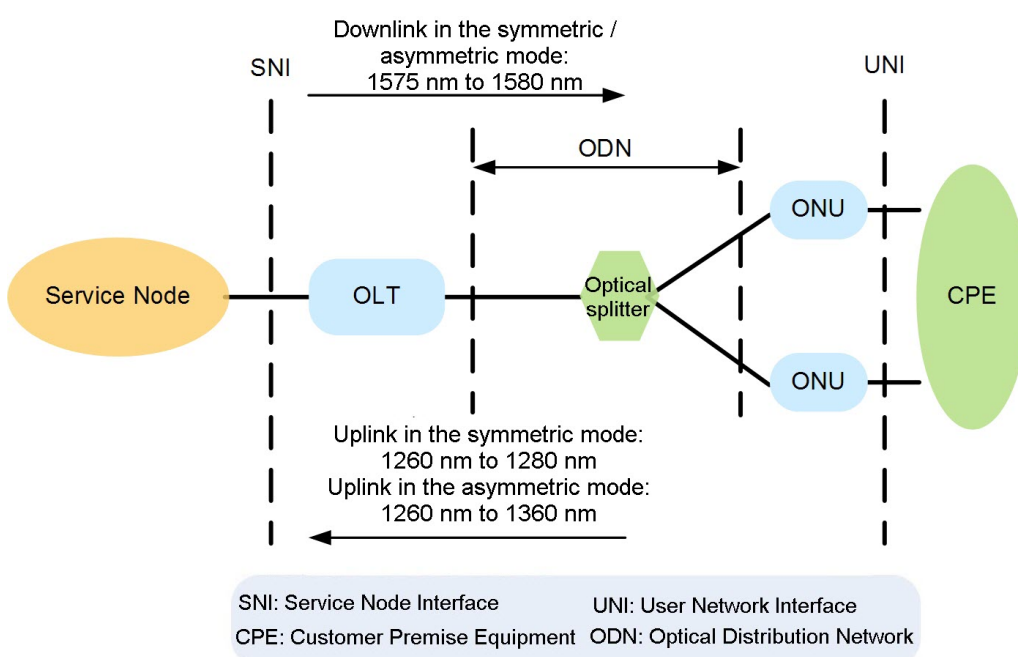

Application

Advantages of 10G EPON application:

- ◆ **Compatibility:** 10G EPON is in the same standard system with EPON. Accordingly, EPON, non-symmetric 10G EPON, and symmetric 10G EPON ONUs can be connected to an OLT via the same ODN. The service model of 10G EPON is same with that of EPON, and is compatible with the existing network management system, using a uniform OAM mechanism.

- ◆ High bandwidth: 10G EPON supports the symmetric rate mode (10 Gbit/s in both uplink and downlink directions) and the non-symmetric rate mode (1.25 Gbit/s in the uplink direction and 10 Gbit/s in the downlink direction). The transmission rates are raised by 10 times compared with that of 1G EPON, and the transmission efficiency is enhanced to 97%.
- ◆ High split ratio: Provides a split ratio up to 1:128.
- ◆ Flexible networking: Users can choose to use EPON ONUs, symmetric 10G EPON ONUs, or non-symmetric 10G EPON ONUs according to their demand for bandwidth. The system can be upgraded on demand. The network is simple and can be configured flexibly. Ultra-long-haul access with high split ratio is supported.
- ◆ Cost-effective: The transfer cost per bit is reduced, and the cost for upgrade is low.

Network Diagram

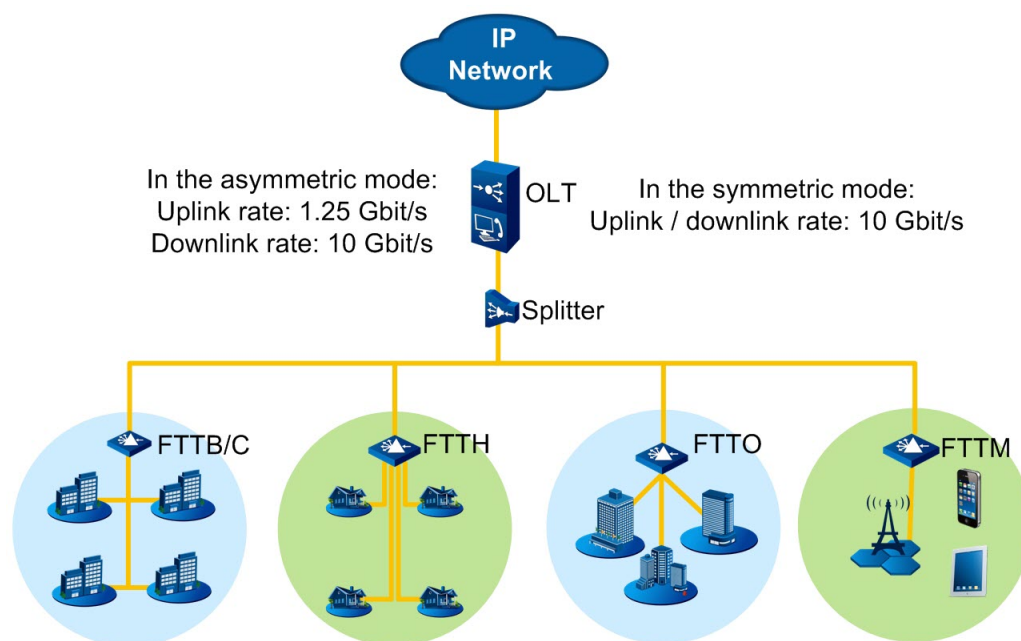

Highlight

- ◆ Smooth upgrade: 10G EPON service cards can replace EPON service cards with little change in configurations. Accordingly, services can be migrated smoothly.

- ◆ Software and hardware compatibility: Bandwidth can be upgraded without replacing subracks. Various PON service cards can coexist in a subrack.
- ◆ Clock and time synchronization with high precision: Uses the system time transfer protocol defined in IEEE 802.1as, and supports synchronous Ethernet (SyncE), IEEE1588 V2 and 1PPS+ToD.
- ◆ Overall protection: Supports backbone fiber protection (Type B) and all-fiber protection (Type C). The switching time is no more than 50 ms.

Functions and Specifications

Function	Specification
Standard compliance	Supports the 10G EPON functions defined in IEEE 802.3av.
Transmission rate	In the symmetric mode: <ul style="list-style-type: none"> ◆ Uplink: 10 Gbit/s ◆ Downlink: 10 Gbit/s In the asymmetric mode: <ul style="list-style-type: none"> ◆ Uplink: 1.25 Gbit/s ◆ Downlink: 10 Gbit/s
Wavelength	In the symmetric mode: <ul style="list-style-type: none"> ◆ Uplink: 1260 nm to 1280 nm ◆ Downlink: 1575 nm to 1580 nm In the asymmetric mode: <ul style="list-style-type: none"> ◆ Uplink: 1260 nm to 1360 nm ◆ Downlink: 1575 nm to 1580 nm
Maximum transmission distance	60 km
Maximum differential fiber distance	60 km
Maximum split ratio	1:128
Detection of optical power	Supports the RSSI detection.
Detection of rogue ONUs	Supports automatic detection and location of ONUs that constantly emit light.
Compatibility	Supports various kinds of ONUs, such as SBU, SFU, MTU, cassette MDU, and MDU which can accommodate cards.
DBA function	Supports three bandwidth types: fixed bandwidth, assured bandwidth, and maximum bandwidth.
	Supports the dynamic bandwidth allocation (DBA) algorithm.
Reliability	Supports Type B, Type C and Type C dual-homing protections.

Function	Specification
Throughput	In the 10G/1G asymmetric access mode, if 10G/1G EPON ONUs are connected only, the downlink throughput is no less than 8.3 Gbit/s, and the uplink throughput is no less than 900 Mbit/s.
	In the 10G/10G symmetric access mode, if 10G/10G EPON ONUs are connected only, the downlink throughput is no less than 8.3 Gbit/s, and the uplink throughput is no less than 8 Gbit/s.
Transmission delay	When the split ratio is 1:32, the uplink average transmission delay (when the traffic is no more than 90% of the PON port throughput) is less than 1.5 ms.
	The downlink average transmission delay (when the traffic is no more than 90% of the PON port throughput) is less than 1 ms.

5.2.4 XG-PON Access Function

Basic Concept

XG-PON is the passive optical network access technology standardized in ITU-T G.987, which is evolved from the ITU-T G.984 (GPON) standard. The figure below shows the network structure of XG-PON.

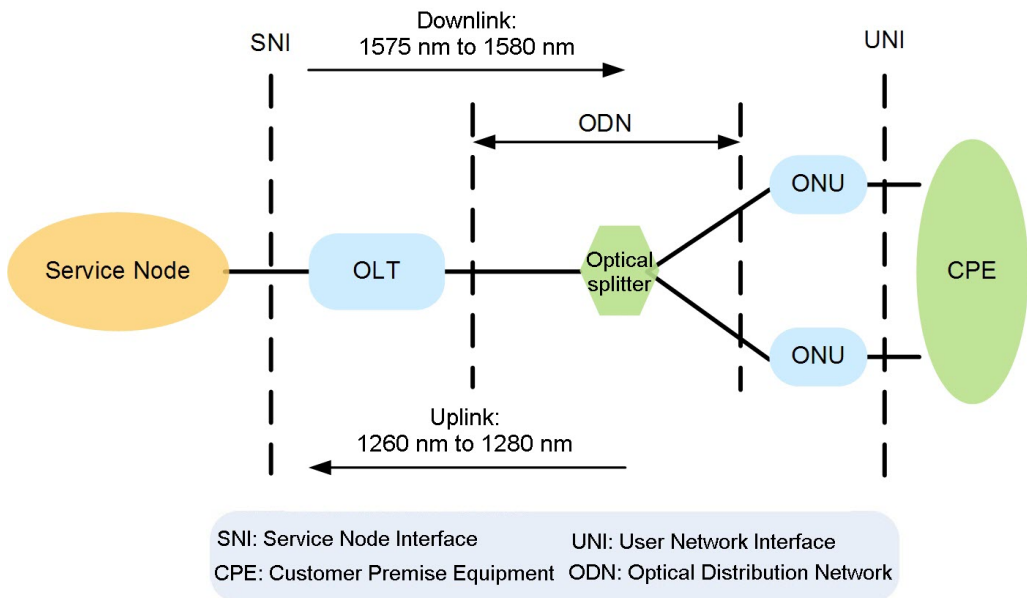

Application

Advantages of XG-PON application:

- ◆ Smooth evolution: All FiberHome OLTs in the current network support XG-PON service cards; therefore, users need not replace existing OLT equipment to provision the XG-PON service.
- ◆ High bandwidth: 2.5 Gbit/s in the uplink direction and 10 Gbit/s in the downlink direction
- ◆ High split ratio: Provides a split ratio up to 1:256.
- ◆ Sharing an ODN: XG-PON ONUs can be connected via an existing GPON ODN, based on the external wavelength division multiplexing (WDM) technology.

Network Diagram

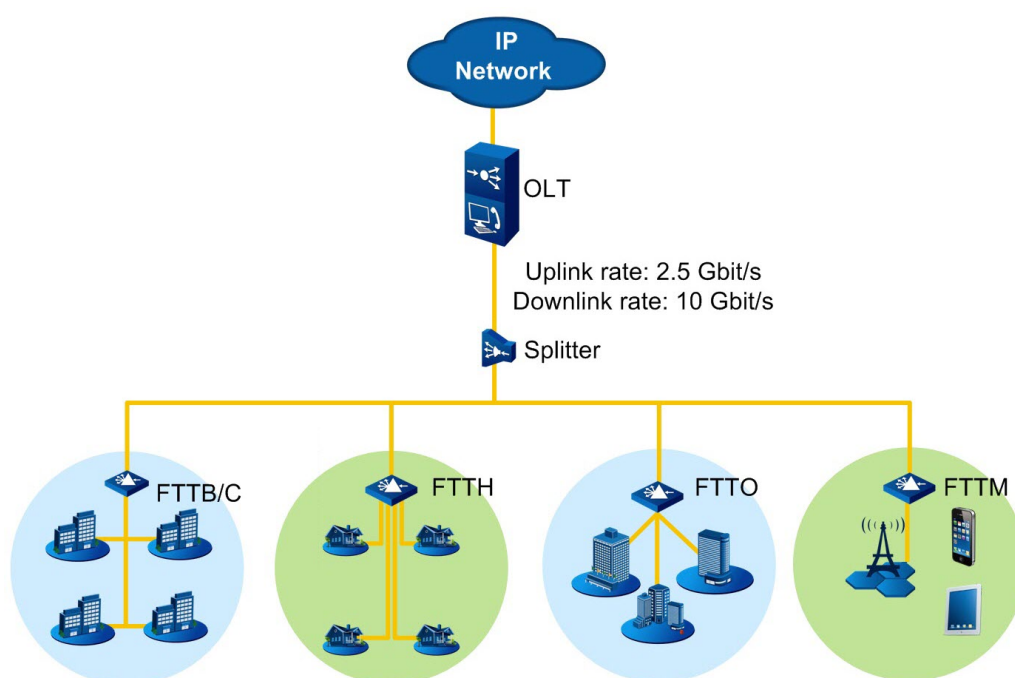

Highlight

- ◆ GPON & XG-PON Combo access: GPON and XG-PON ONUs can be connected via the same service card.
- ◆ Smooth upgrade: XG-PON service cards can replace GPON service cards with little change in configurations. Accordingly, services can be migrated smoothly.

- ◆ Software and hardware compatibility: Bandwidth can be upgraded without replacing subracks. Various PON service cards can coexist in a subrack.
- ◆ Clock and time synchronization with high precision: Uses the system time transfer protocol defined in IEEE 802.1as, and supports synchronous Ethernet (SyncE), IEEE1588 V2 and 1PPS+ToD.
- ◆ Overall protection: Supports backbone fiber protection (Type B) and all-fiber protection (Type C). The switching time is no more than 50 ms.
- ◆ Transmits data in an efficient way:
 - ▶ Encapsulates all the data to be transmitted into 125 us frames (fixed length frames) with the new GEM encapsulation structure, which uses fewer transmission overhead bytes and improves the transmission efficiency.
 - ▶ The transmission efficiency can reach 93% when the downlink rate is 10 Gbit/s and the uplink rate is 2.5 Gbit/s.

Functions and Specifications

Function	Specification
Standard compliance	Conforms to ITU-T G.987 series of standards, with good interoperability.
Transmission rate	<ul style="list-style-type: none"> ◆ Uplink: 2.5 Gbit/s ◆ Downlink: 10 Gbit/s
Wavelength	<ul style="list-style-type: none"> ◆ Uplink: 1260 nm to 1280 nm ◆ Downlink: 1575 nm to 1580 nm
Maximum transmission distance	60 km
Maximum differential fiber distance	40 km
Maximum split ratio	1:256
Detection of optical power	Supports the RSSI detection.
Detection of rogue ONUs	Supports automatic detection and location of ONUs that constantly emit light.
Compatibility	Supports various kinds of ONUs, such as SBU, SFU, MTU, cassette MDU, and MDU which can accommodate cards.
DBA function	Dynamically allocates bandwidth according to subscribers' traffic status.
Reliability	Supports Type B, Type C and Type C dual-homing protections.

Function	Specification
Throughput	When the XG-PON system bears Ethernet services only and is fully configured with services (64 ONUs), the uplink throughput is no less than 1.9 Gbit/s, and the downlink throughput is no less than 8.5 Gbit/s.
Transmission delay	The uplink average transmission delay (when the traffic is no more than 90% of the system throughput) is less than 1.5 ms (packets of all sizes are counted).
	The downlink average transmission delay (when the traffic is no more than 90% of the system throughput) is less than 1 ms (packets of all sizes are counted).

5.2.5 XGS-PON Access Function

Basic Concept

XGS-PON is the passive optical network access technology standardized in ITU-T G.9807, which is evolved from the ITU-T G.987 (XG-PON) standard. The figure below shows the network structure of XGS-PON.

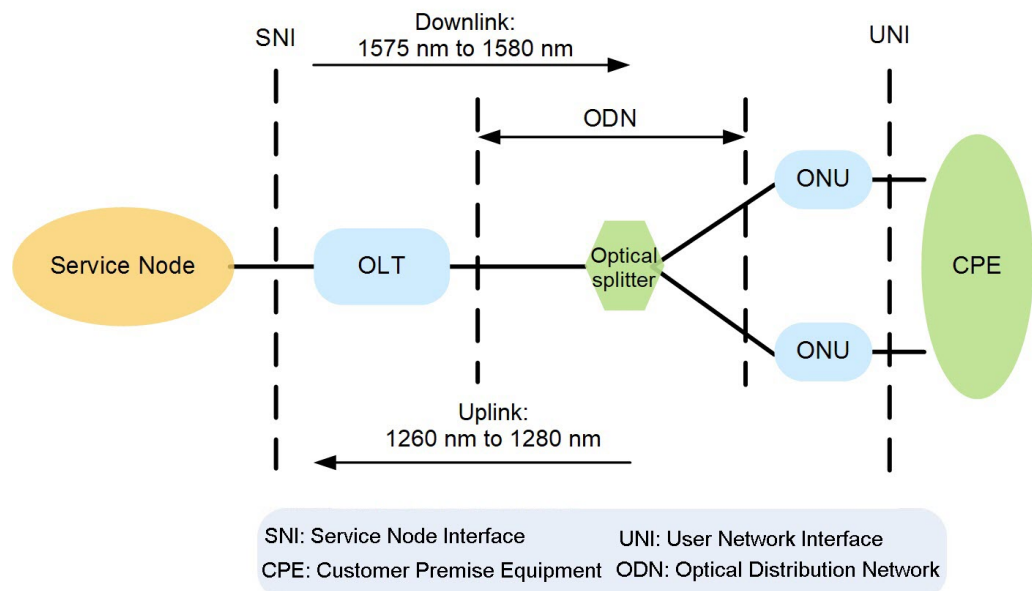

Application

Advantages of XGS-PON application:

- ◆ Smooth evolution: All FiberHome OLTs in the current network support XGS-PON service cards; therefore, users need not replace existing OLT equipment to provision the XGS-PON service.
- ◆ High bandwidth: 10 Gbit/s in both uplink and downlink directions.
- ◆ High split ratio: Provides a split ratio up to 1:256.
- ◆ Compatible with XG-PON: XG-PON ONUs can coexist with XGS-PON ONUs in an ODN.
- ◆ Sharing an ODN: XG-PON ONUs or XGS-PON ONUs can be connected via an existing ODN.

Network Diagram

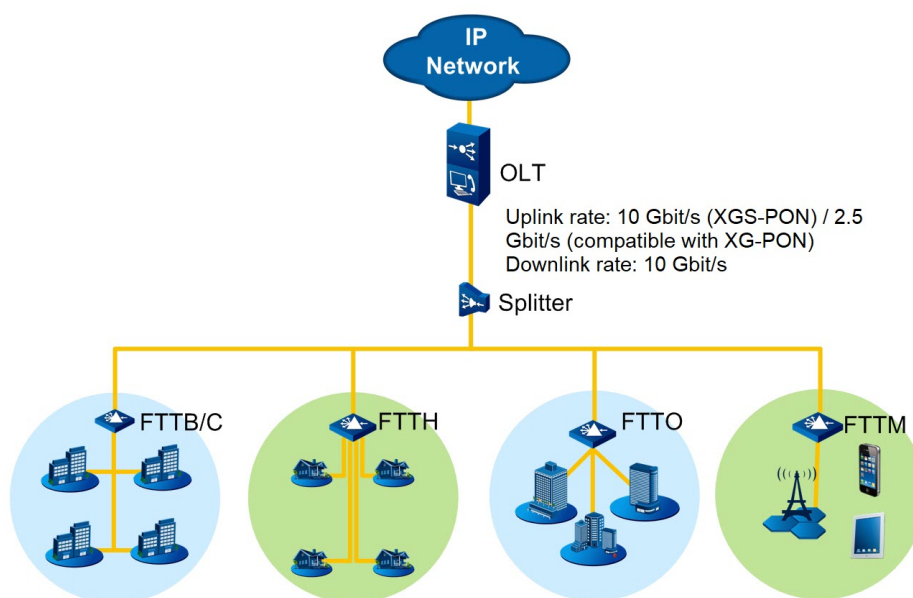

Highlight

- ◆ Smooth upgrade: XGS-PON service cards can replace XG-PON service cards with little change in configurations. Accordingly, services can be migrated smoothly.
- ◆ Software and hardware compatibility: Bandwidth can be upgraded without replacing subracks. Various PON service cards can coexist in a subrack.

- ◆ Low power consumption: An XGS-PON card consumes power less than 70 W.
- ◆ Clock and time synchronization with high precision: Uses the system time transfer protocol defined in IEEE 802.1as, and supports synchronous Ethernet (SyncE), IEEE1588 V2 and 1PPS+ToD.
- ◆ Overall protection: Supports backbone fiber protection (Type B) and all-fiber protection (Type C). The switching time is no more than 50 ms.
- ◆ Efficient data transmission: Encapsulates all the data to be transmitted into 125 us frames (fixed length frames) with the new XGEM encapsulation structure, which uses fewer transmission overhead bytes and improves the transmission efficiency.

Functions and Specifications

Function	Specification
Standard compliance	Conforms to ITU-T G.987 and G.9807 series of standards, with good interoperability.
Transmission rate	The uplink and downlink rates can reach 10 Gbit/s.
Wavelength	<ul style="list-style-type: none"> ◆ Uplink: 1260 nm to 1280 nm ◆ Downlink: 1575 nm to 1580 nm
Maximum transmission distance	60 km
Maximum differential fiber distance	40 km
Maximum split ratio	1:256
Detection of optical power	Supports the RSSI detection.
Detection of rogue ONUs	Supports automatic detection and location of ONUs that constantly emit light.
Compatibility	Supports various kinds of ONUs, such as SBU, SFU, MTU, cassette MDU, and MDU which can accommodate cards.
DBA function	Dynamically allocates bandwidth according to subscribers' traffic status.
Reliability	Supports Type B, Type C and Type C dual-homing protections.
Throughput	In the 10G/2.5G asymmetric access mode, when the XGS-PON system is fully configured with services (64 ONUs), the uplink throughput is no less than 1.9 Gbit/s, and the downlink throughput is no less than 8.5 Gbit/s.

Function	Specification
	In the 10G/10G symmetric access mode, when the XGS-PON system is fully configured with services (64 ONUs), both the uplink throughput and the downlink throughput are no less than 8.5 Gbit/s.
Transmission delay	The uplink average transmission delay (when the traffic is no more than 90% of the system throughput) is less than 1.5 ms (packets of all sizes are counted).
	The downlink average transmission delay (when the traffic is no more than 90% of the system throughput) is less than 1 ms (packets of all sizes are counted).

5.3 Layer 2 Function

This section introduces the Layer 2 functions supported by the AN6000 Series, including VLAN and Layer 2 forwarding strategies.

5.3.1 VLAN Function

Basic Concept

Virtual local area network (VLAN) is a communication technology that divides a physical LAN into multiple logical domains.

The format of Ethernet frames is modified in the IEEE802.1Q. A four-byte VLAN tag is inserted behind the source MAC address field to identify the logical domain of the packet source equipment.

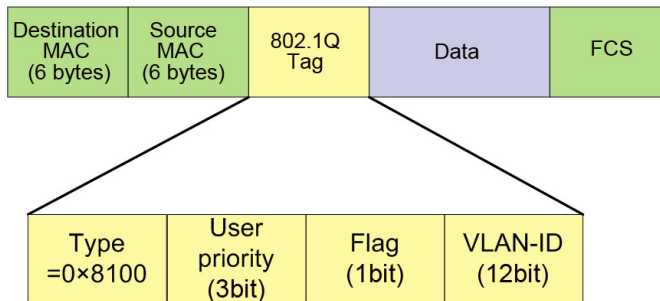

The fields contained in a VLAN Tag are defined as follows:

- ◆ Type: This field indicates the frame type. The value is set to 0x8100, indicating that the frame carries a 802.1Q tag.
- ◆ User Priority: This field indicates user priority. The value ranges from 0 to 7, standing for eight priority levels.
- ◆ Flag: The value of this field is set to 0 in Ethernet application.
- ◆ VLAN-ID: The value ranges from 0 to 4095 to identify different VLANs.

Application

- ◆ Saving network resource: Keep broadcast packets inside a VLAN to avoid a waste of bandwidth caused by broadcast storm.
- ◆ Security: The hosts in different VLANs cannot communicate with each other directly, and this enhances network security.
- ◆ Flexible service: The operators can plan their services flexibly through VLAN management.

Network Diagram

There are three typical scenarios for VLAN application.

- ◆ VLAN aggregation: The VLAN aggregation technology is applied to Layer 3 logical network to avoid insufficient use of IP addresses.
- ◆ QinQ VLAN: The QinQ technology improves VLAN utilization, and can be applied to metro Ethernet network to distinguish between a large number of users.
- ◆ Stacking VLAN: The stacking VLAN technology is applied to scenarios with more than one Internet service providers (ISPs) in a network to deliver services from different ISPs to users correctly and quickly.

The networks for the three application scenarios are as follows:

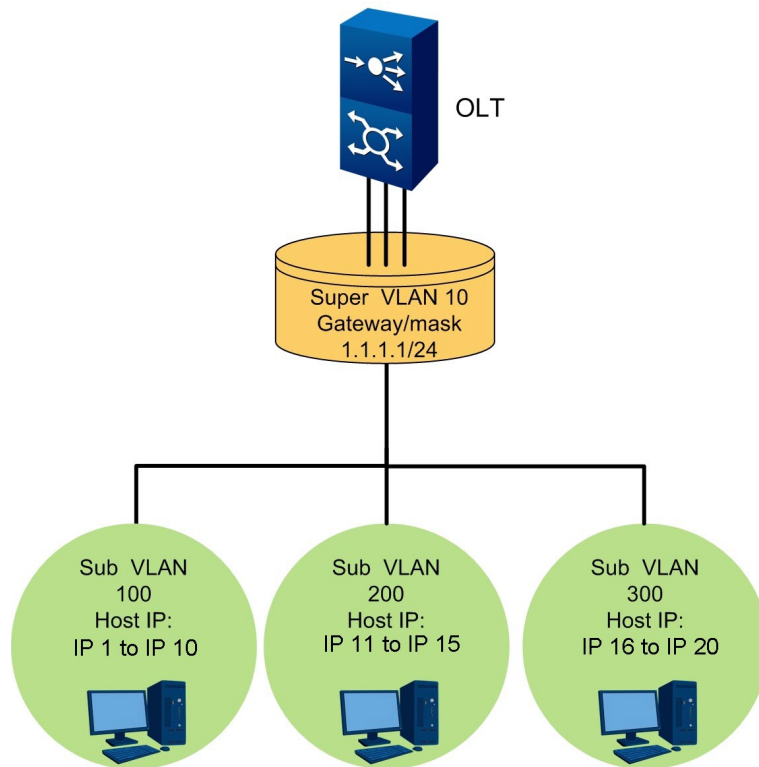

Figure 5-1 VLAN Aggregation

The table below describes a VLAN aggregation network example. In this example, intercommunication among three domains is achieved with sufficient use of IP addresses.

Sub VLAN	Super VLAN	Gateway Mask	Number of Available Addresses	Available IP Address
100	10	1.1.1.1/24	10	IP addresses 1 to 10
200			5	IP addresses 11 to 15
300			5	IP addresses 16 to 20

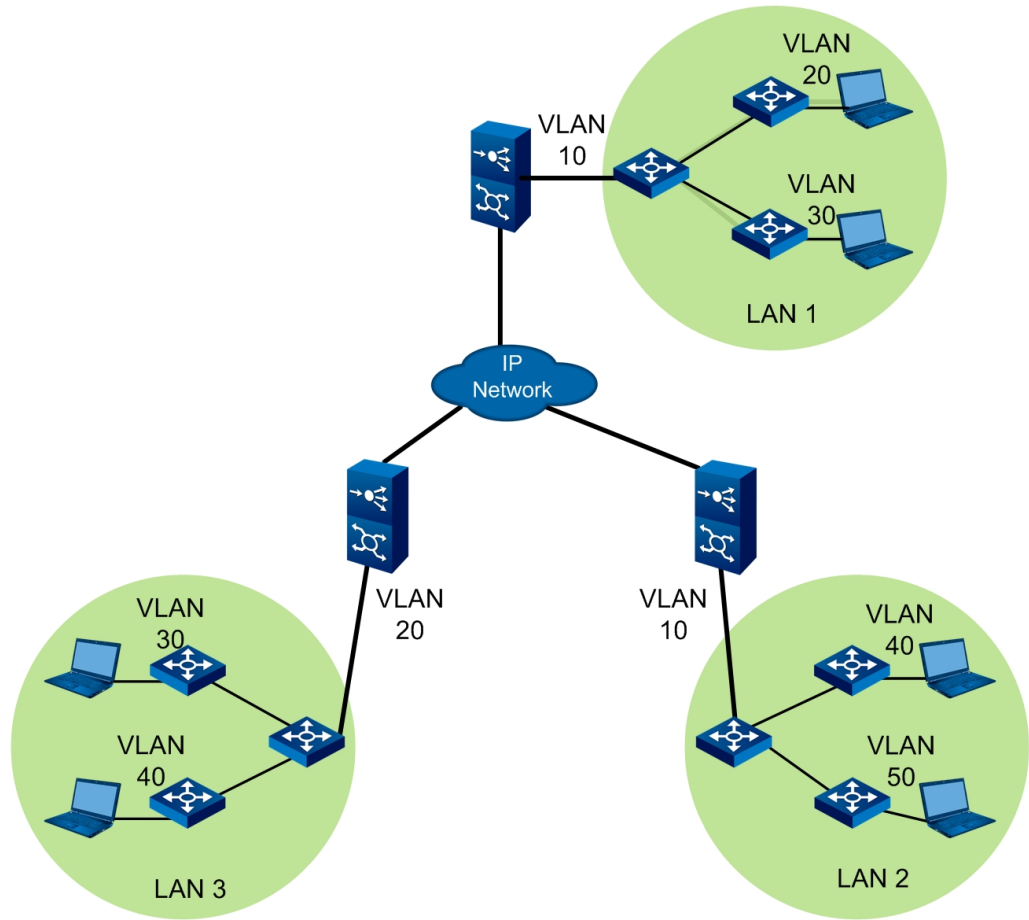

Figure 5-2 QinQ VLAN

The table below describes a QinQ VLAN network example. In this example, LAN1 and LAN2 are in different locations but can communicate with each other. LAN3 cannot communicate with LAN1 or LAN2.

User	Inner VLAN	Outer VLAN
LAN 1	20	10
	30	
LAN 2	40	
	50	
LAN 3	30	20
	40	

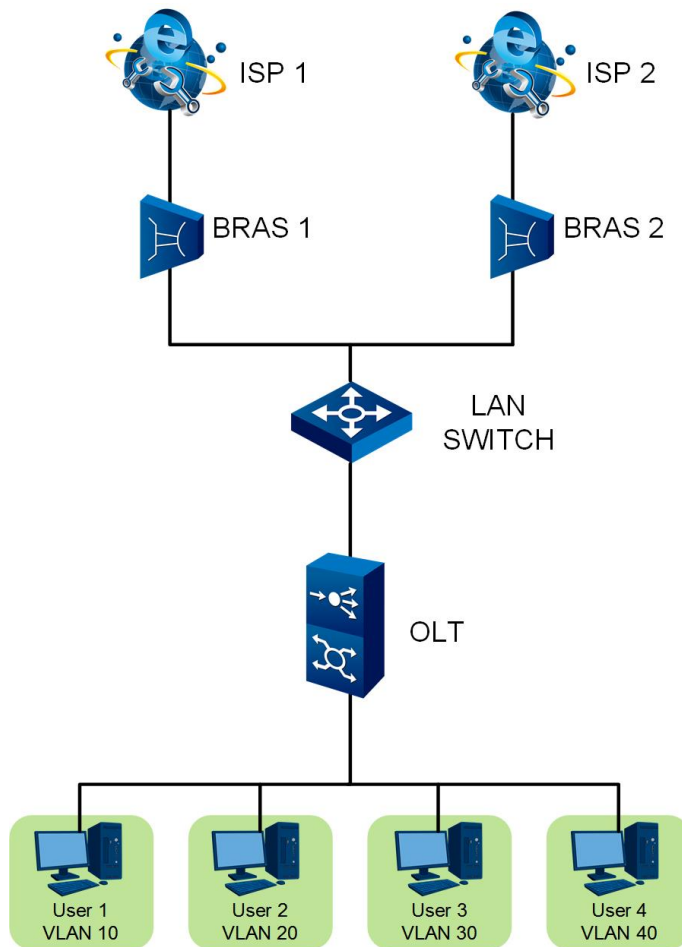

Figure 5-3 Stacking VLAN

The table below describes a Stacking VLAN network example, where inner VLANs are used to identify users, and outer VLANs identify services. In this way, services of different types can be delivered to users correctly and quickly.

User	Inner VLAN (Identifying Users)	Outer VLAN (Identifying Services)
User 1	10	10
User 2	20	
User 3	30	20
User 4	40	

Highlight

- ◆ Virtual OLT: With the virtual OLT technology, multiple services can be carried by the same optical network. Based on the infrastructures provided by basic telecom operators, virtual network operators are set into different management domains, and their services are separated.
- ◆ VLAN aggregation: In a Layer 3 switch, the broadcast domains communicate with each other with each VLAN corresponding to a Layer 3 logical interface. This may cause insufficient use of IP addresses. VLAN aggregation, also known as Super VLAN, can solve this problem.
- ◆ QinQ VLAN: The VLAN tags defined in the IEEE 802.1Q standard can identify a maximum of 4096 VLANs, which cannot completely distinguish between a large number of users in metro Ethernet networks. The QinQ technology solves this problem.
- ◆ Stacking VLAN: Users and services are well distinguished so that services of different types can be delivered to users correctly and quickly.

Functions and Specifications

The table below lists the VLAN functions supported by the equipment.

Function	Specification
VLAN	VLAN aggregation
	QinQ VLAN
	Stacking VLAN
	VLAN translation

The numbers of VLANs supported by typical cards of the equipment are listed in the table below.

Card	Number of Single VLANs	Number of Translated VLANs
HSCA	4096	NA
GPOA	4096	16384
EX8A	4096	16384
EXOA	4096	32768
GX8A	4096	32768
GM8A	4096	32768
GMOA	4096	32768
GNOA	4096	32768

5.3.2 Layer 2 Forwarding Strategy

Basic Concept

As Layer 2 network devices, the AN6000 Series support transparent transmission or forwarding of packets in the Layer 2 network. Traditional Layer 2 forwarding is based on the VLAN information and MAC address of the packets, i.e., VLAN + MAC forwarding.

In the VLAN + MAC forwarding, after the packets are received by the switch, their VLAN IDs, MAC addresses and port numbers are learned. The VLAN ID and MAC address are used to search for the forwarding table and determine the No. of the destination port, to which the packets are then forwarded.

In the SVLAN + CVLAN forwarding, a Layer 2 forwarding mapping is set up between SVLAN IDs and CVLAN IDs, and packets are forwarded based on the VLAN IDs, no longer depending on the learning of MAC addresses.

Application

The SVLAN + CVLAN forwarding solves the following problems encountered by the VLAN + MAC forwarding:

- ◆ Overcomes the limit on MAC address number.
- ◆ Settles the security issue caused by invalidation of the destination MAC address due to the dynamic MAC address aging mechanism.
- ◆ Protects against MAC address spoofing and attacks to enhance security.

Highlight

Instead of being learned dynamically, the entries of the SVLAN + CVLAN forwarding table are created automatically by the system during creation of the service flow. The forwarding table entries are used to determine the uplink port for forwarding the uplink packets and the service virtual port for forwarding the downlink packets.

In the SVLAN + CVLAN forwarding, the service channels need not learn the MAC addresses. This helps prevent leakage of user information and MAC address spoofing and attacks after the MAC addresses are aged due to limited number of MAC addresses, and enhance the system security.

5.4 Voice Service Function

Basic Concept

Voice services include telephone, fax, Modem transmission, value-added services, and so on, where voice signals are transmitted in the network based on specified protocols in specified ways.

Application

- ◆ Saving communication cost: Voice communication data are carried by the IP network to make full use of network resources. The communication cost is reduced while the service quality is guaranteed thanks to the increasingly improved network transmission technology, encoding technology, and QoS technology.
- ◆ Abundant maintenance measures: The VoIP voice network based on the softswitch provides abundant maintenance measures at the access side, including line status query, line test, performance statistics, call emulation, and so on, to meet the demands for network OAM.
- ◆ High reliability: Technologies including dual-homing, QoS, real-time transmission protocol, heartbeat / keep-alive mechanism, and hot backup mechanism are used to ensure reliability of the VoIP voice service.

Network Diagram

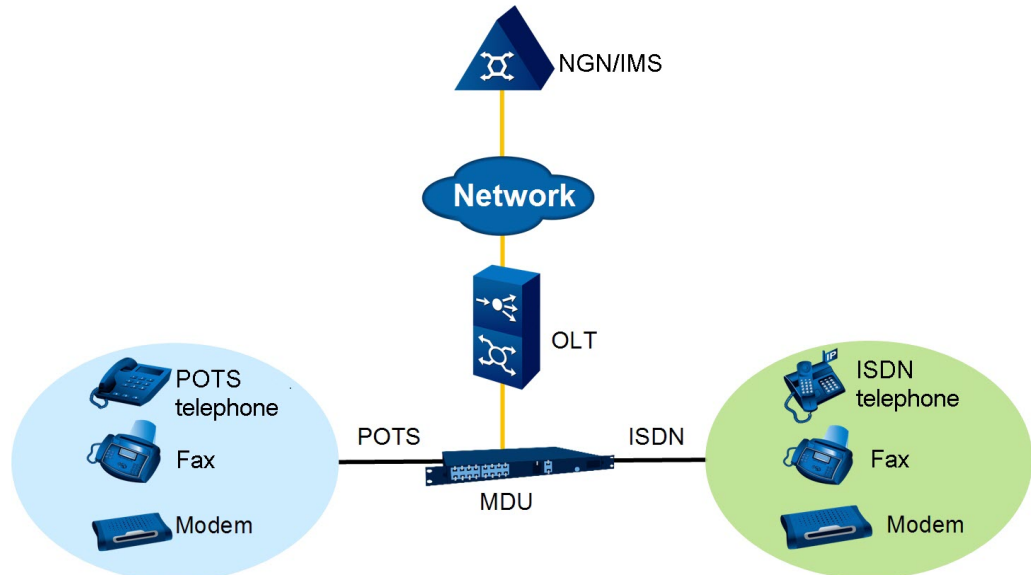

Highlight

- ◆ Supports voice communication inside PON. When different ONUs or POTS subscribers within an OLT communicate with each other, media streams circulate inside the OLT system through the Proxy ARP in the PON. In this way, traffic in the network is reduced.
- ◆ Reliability: Supports dual-homing and heartbeat mechanism, and monitors the status of the core network server in real time. When the active server is faulty, the subscriber services will be automatically switched to the standby server, so that the services will not be interrupted.
- ◆ Supports the emergency standalone function for POTS voice services. When the uplink softswitch network is interrupted, the communication between the voice subscribers inside the POTS system will not be affected.
- ◆ Compatible with both NGN and IMS networks. When the core network is upgraded from NGN to IMS, the equipment at the access side need not be upgraded.

Functions and Specifications

Function	Specification
Standard compliance	Supports the protocols H.248 and SIP to set up a network with the softswitch and enable the NGN voice services.
	Supports the protocol SIP to set up a network with the IMS and provision the NGN voice services.
Encoding mode	G.711 (A-law/ μ -law), G.722, G.723.1, G.726, G.728, and G.729
Dynamic switching time for speech encoding	< 60 ms
Incidence of voice interruption and jitter	Standard G.711: 0
	Standard G.723.1: < 2%
	Standard G.729: < 5%
Objective evaluation of voice	When the network is in quite good condition, the average value of PSQM is less than 1.5.
	When the network is in poor condition (packet loss rate = 1%, jitter = 20 ms, transmission delay = 100 ms), the average value of PSQM is less than 1.8.
	When the network is in extremely bad condition (packet loss rate = 5%, jitter = 60 ms, transmission delay = 400 ms), the average value of PSQM is less than 2.0.
Subjective evaluation of voice	When the network is in quite good condition, the packetization interval of G.711A RTP packets is 20 ms, and the MOS is larger than 4.0.
	When the network is in poor condition (packet loss rate = 1%, jitter = 20 ms, transmission delay = 100 ms), the packetization interval of G.711A RTP packets is 20 ms, and the MOS is larger than 3.5.
	When the network is in extremely bad condition (packet loss rate = 5%, jitter = 60 ms, transmission delay = 400 ms), the packetization interval of G.711A RTP packets is 20 ms, and the MOS is larger than 3.0.
Encoding rate	Standard G.711: 64 kbit/s
	Standard G.729a: < 18 kbit/s
	Standard G.723.1 (5.3): < 12 kbit/s
	Standard G.723.1 (6.3): < 15 kbit/s
Loopback delay	Standard G.729a: < 150 ms
	Standard G.723.1: < 200 ms
Call loss rate	< 0.01%
Fax mode	T.30 and T.38
Voice function	Provides the analogue line testing function for POTS interfaces.

Function	Specification
	Supports multi-MGC.
	Supports IEEE 802.1Q and priority setting for the VLAN of each voice channel.
	Supports QinQ for voice services.
	The call processing capability is 25k BHCA.
	The call completing rate exceeds 99.999%.
	Supports the IP phone access service for POTS subscribers.
	Supports transparent transmission of the MoIP service.
	Supports pulse accounting and polarity-reversal accounting.
	Supports the IP CENTERX service.
	Supports telephone ringing and ringing-off.
	Supports adjustment of gain.
Intelligent voice service	Supports calling number identification (CNID) presentation and restriction, call waiting, three-way conversation, alarm service, call forwarding (unconditional, busy and no answer), immediate hotline, outgoing call barring (OCB), and distinctive ring.

5.5 Multicast Service Function

Basic Concept

Multicast is a communication mode in which one copy of data packets is sent to multiple subscribers. Each multicast address stands for a multicast group, and all hosts in a multicast group can receive same data from a multicast source.

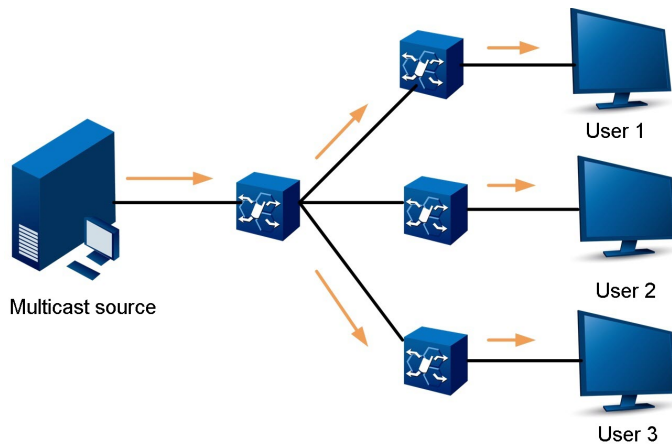

Application

- ◆ Saving bandwidth: Each link has no repeated multicast data flow. This helps save network bandwidth.
- ◆ Lessening load: In multicast mode, increase of subscribers does not visibly increase the burden on a network. This helps avoid heavy load on video servers and CPUs.
- ◆ Long-haul transmission: Multicast packets can be transmitted across network segments to allow long-haul transmission of massive data.
- ◆ Security: Multicast packets are transmitted only to expected receivers, so as to guarantee the security of information.

Network Diagram

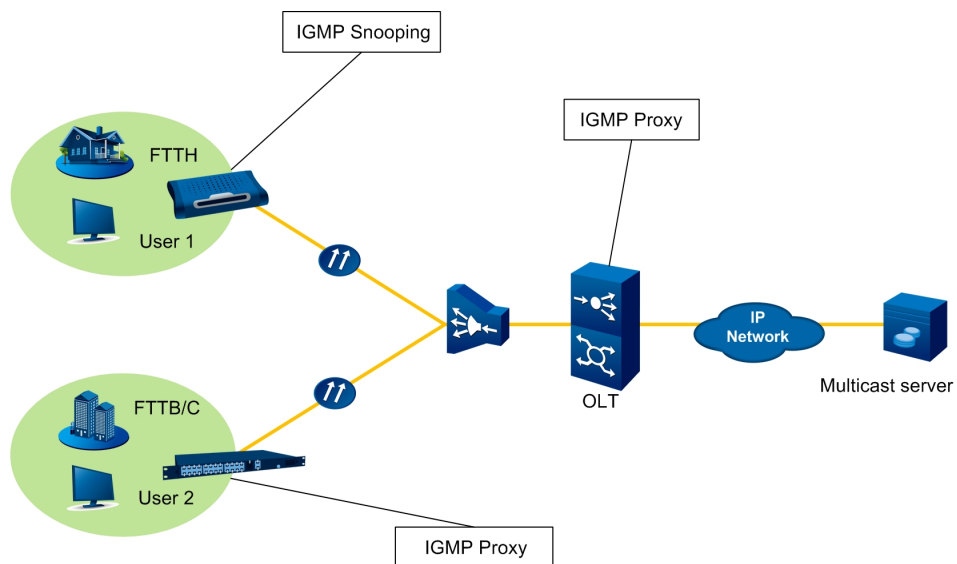

Highlight

- ◆ Multicast capability
 - ▶ Supports multicast emulation.
 - ▶ Supports up to 4096 concurrently online multicast users.
 - ▶ Queries multicast flows based on ports.
- ◆ Fault isolation

- ▶ Multicast emulation: A multicast emulation test emulates an end user going online, and engineers query the real-time traffic of the multicast program and the user information to isolate the fault.
- ▶ User log: Querying a user log helps find out the cause of a user's failure in ordering a program or the user's operations leading to such a failure.
- ▶ IGMP statistics: Based on statistics of IGMP packets, you can determine whether these packets are received or transmitted normally.

Functions and Specifications

Function	Specification
Multicast functions and features	Supports IGMP V1 / V2 / V3.
	Supports MLD V1 / V2.
	Supports IGMP Proxy, IGMP Snooping, MLD Proxy and MLD Snooping functions.
	Supports the pre-joining function; i.e., subscribers can pre-join a multicast group for a designated program to enable their quick access to the program on demand.
	Supports the preview function.
	Supports multicast cascade.
	Supports cross-VLAN multicast.
	Supports management and identification of subscribers and program sources based on multicast VLANs.
	Controls dynamic joining, leaving or maintaining of multicast group members through IGMP / MLD Report, Leave and Query messages.
	Supports multicast statistics: Program ordering times, as well as the total and average duration of watching ordered programs are counted for each multicast group or user port.
	Supports online query of multicast information. Online multicast groups, group members and their statuses can be queried hierarchically based on core switch cards, service cards, and ONUs.
	Supports controllable multicast.
	Supports multicast translation.
	Supports multicast services over multiple VLANs.
Supports IGMP fast leave.	

5.6 Network Slicing Function

Basic Concept

A physical OLT is divided into multiple logical slices, or virtual systems (VS) via the virtualization technology. Each VS can serve as an independent OLT logically and can be separately deployed with services and managed.

- ◆ The management VS manages all physical resources, and creates and manages service VSs.
- ◆ A service VS can manage its own physical resources and can be deployed with services independently.

Application

Advantages of network slicing application:

- ◆ A physical device is virtualized into several logical devices to enhance the device utilization and reduce the deployment cost.
- ◆ The slicing technology helps achieve unified bearing and demand-based classification of services. That is, a physical access network is divided into several virtual access networks to carry different services.
- ◆ Independent resources and separated services: The forwarding and control resources are virtualized, and each slice has unique access to these resources to ensure forwarding security and enhance reliability of private line services.
- ◆ The virtual access networks are managed based on authorization and domain division. Each slice is independently planned, operated and managed, with easier maintenance.

Network Diagram

Network slicing can be applied to scenarios with multiple services and multiple tenants. The figure below shows the network diagram for this application.

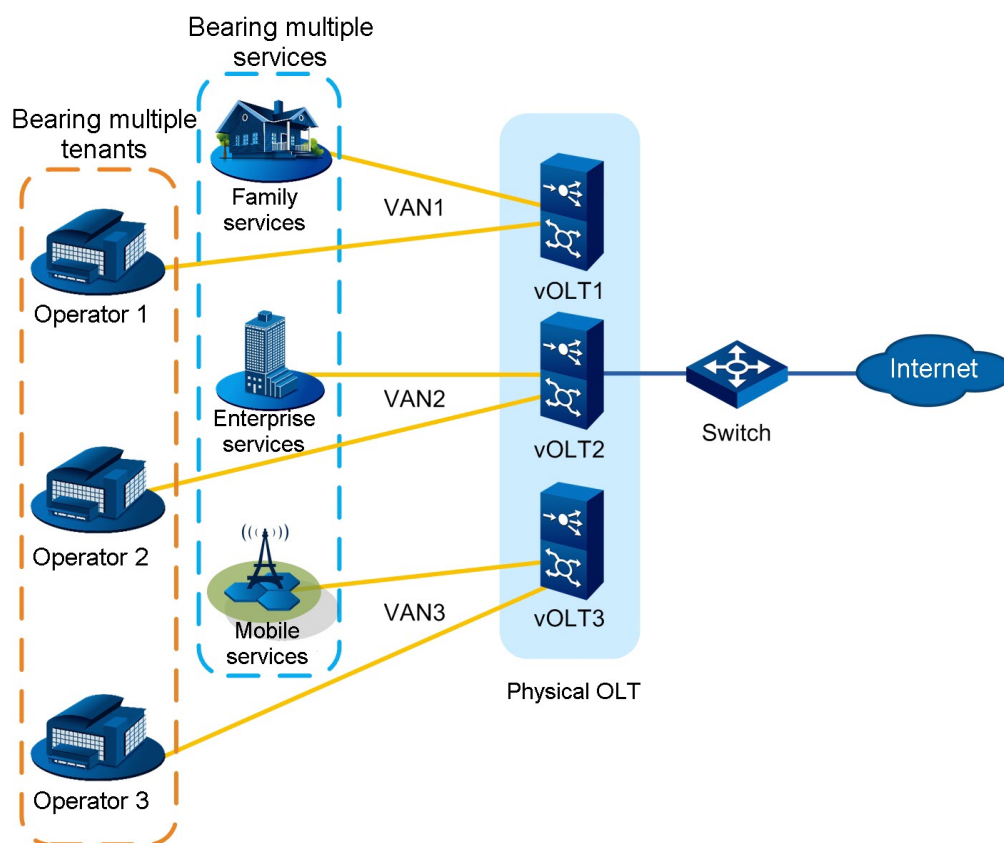

Highlight

- ◆ Supports up to eight OLT slices, with services deployed and resources planned separately.
- ◆ The slice resources can be flexibly configured. Slicing based on cards, PON ports, ONUs or combination of them is supported.
- ◆ The slices are managed independently, with their logs, alarm files and configuration files stored separately to simplify OAM. The IP addresses of the slices can be managed uniformly or independently.
- ◆ Uplink ports can be shared based on VLAN and VXLAN IDs. That is, an uplink port can belong to several slices, with the services from different slices identified by the specified VLAN and VXLAN IDs and forwarded respectively.

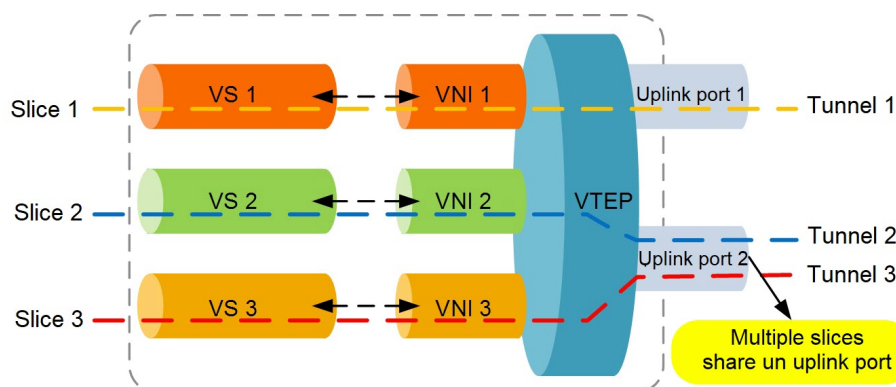

Functions and Specifications

Function	Specification
Maximum number of slices	8
Slicing granularity supported	Card, PON port, ONU or the combination of them
Definition of the resource collection	The resource types include the number of VLANs, number of MAC addresses, number of multicast addresses, and number of equipment management users.
Forwarding independence	Each slice has independent VLAN resources (4096 VLANs at most); VLAN configuration can be overlapped between slices; and different slices can learn the same MAC address.
Management independence	Each slice has independent service configuration, DBA, QoS, performance statistics and management, logs and alarms.
Uplink port sharing	Uplink ports can be shared by slices based on VLAN and VXLAN IDs.

5.7 VXLAN Function

Basic Concept

VXLAN is a tunnel technology using MAC Address-in-User Datagram Protocol (MAC-in-UDP) encapsulation. Data packets are encapsulated in UDP via VXLAN tunnel endpoints (VTEP) and further encapsulated with outer headers (IP and MAC addresses of a physical network). After that, the packets are transmitted over the IP network. At the destination, the tunnel endpoints decapsulate the packets and send them to expected receivers.

Application

Advantages of VXLAN application:

- ◆ Supports up to 16M VXLAN segments for network isolation (in comparison, VLAN supports only a little more than 4000 virtual network IDs). This helps remove the bottleneck on user isolation and identification, and support a large number of tenants.
- ◆ When VXLAN encapsulation is used, only edge devices in a VXLAN need to identify MAC addresses on the user side. This relieves the MAC address learning pressure on other devices and improves their performance.
- ◆ Extends Layer 2 networks by using MAC-in-UDP encapsulation, and decouples physical and virtual networks. This facilitates configuration and migration of virtual machines on the user side.
- ◆ In the scenario where there is a centralized data center in the access equipment room, VXLAN technology is used to distribute user services to their VXLAN tunnels respectively and connect them to a cloud computing center. In this way, services can be imported to corresponding network function modules (such as vBRAS and vBNG) for processing, isolated from each other with their quality assured.

Network Diagram

The VXLAN tunnel technology has now been widely used in data centers. With the development of telecoms network virtualization and data centralization, a large number of services are shifted to the cloud-end virtual machines. Accordingly, service functional pools, e.g. vBRAS, come into being. This not only makes services more flexible and scalable, but also integrates services to enhance equipment utilization. The OLT supports the VTEP function and can set up VXLAN connections with virtual machines in the data center equipment room. When the number of tenants increases, vBRAS can use the VXLAN technology to identify them. In this way, a large number of tenants are supported.

The network for VXLAN application is as follows:

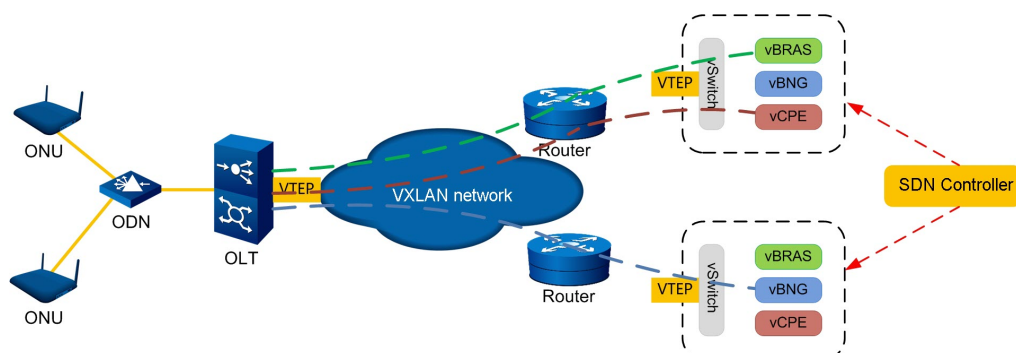

Highlight

- ◆ Supports static configuration or dynamic learning of the peer VTEP.
- ◆ Supports flexible definition or remapping of service priorities.
- ◆ Supports flexible tunnel mappings (mappings to VNIs based on slices, PON service cards, PON ports and ONUs).

Functions and Specifications

Function	Specification
VTEP	Configurable MAC and IP addresses for a VTEP
Number of VXLAN tunnels supported	16384
Number of concurrently active VNIs	4096
Supported VNI range	1 to 16777215
Number of VXLAN MAC table entries supported	65536
VNI mapping mode	Mapping network slices to VNIs
	Mapping PON service cards to VNIs
	Mapping PON ports to VNIs
	Mapping VLANs to VNIs
	Mapping PON ports + VLANs to VNIs
	Mapping ONUs to VNIs
	Mapping between VXLAN packet priorities and original packet priorities

5.8 Layer 3 Function

This section introduces the Layer 3 functions supported by the AN6000 Series, including OSPF, DHCP Relay and ARP Proxy.

5.8.1 OSPF Function

Basic Concept

Open Shortest Path First (OSPF) is an interior gateway protocol to implement the link state routing protocol. It is generally applied to a single autonomous system (AS). All the OSPF routers in this AS maintain a same database that describes the AS structure. The database keeps the status information of the links in the routing domain. The OSPF router works out the OSPF routing table according to this database.

Application

- ◆ Wide application: Supports networks of different sizes. Large-sized data exchange networks with several hundred routers are supported.
- ◆ Fast convergence: When the network topology changes, OSPF immediately sends LSU (Link State Update) packets to synchronize the changes to the LSBs (Link State Databases) of all routers in the autonomous system.
- ◆ Loop-free: OSPF uses the SPF algorithm to calculate loop-free routes based on the collected link status.
- ◆ Area partition: OSFP allows an AS to be partitioned into areas to simplify management. Routing information transmitted between areas is further summarized to reduce network bandwidth consumption.

Network Diagram

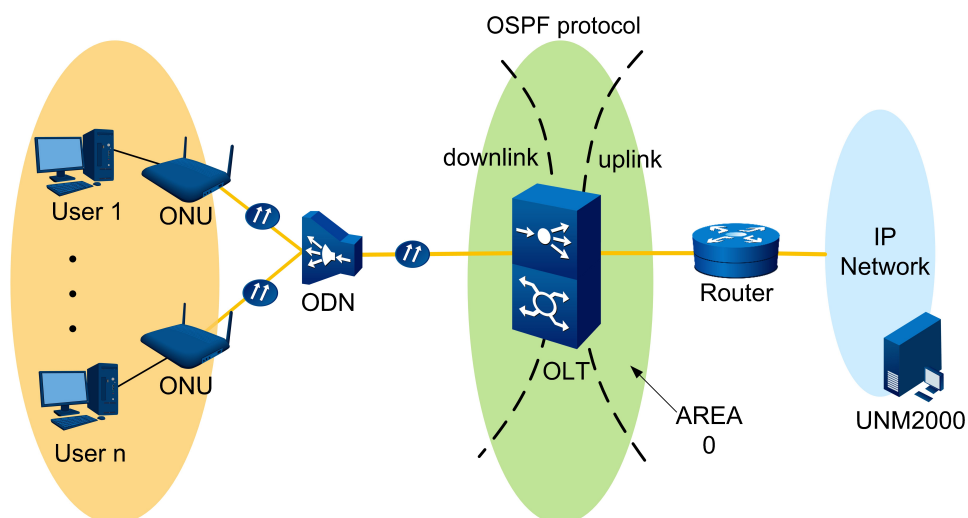

Highlight

- ◆ Equal-cost route: OSPF allows multiple equal-cost routes to the same destination.
- ◆ Routing hierarchy: OSPF uses four route types: intra-area routes, inter-area routes, Type 1 external routes, and Type 2 external routes, which are listed in descending order of priority.
- ◆ Authentication: OSPF supports interface-based packet authentication, which ensures security of protocol packet exchange.
- ◆ Multicast: OSPF uses multicast addresses to send protocol packets on links supporting multicast. This minimizes the impact on other devices.

Functions and Specifications

The AN6000 Series support the OSPF routing table with 16384 entries. The tables below list the router and route types supported by the equipment.

OSPF Router	Meaning
Internal Router	Intra-area router
Area Border Router	Area border router
Backbone Router	Backbone router
AS Boundary Router	Autonomous system boundary router (ASBR)

OSPF Route	Meaning
Intra Area	Intra-area route
Inter Area	Inter-area route
Type 1 external route	Cost of a Type 1 external route = Cost of the route from a Router to an ASBR + Cost of the route from the ASBR to the destination
Type 2 external route	Cost of a Type 2 external route = Cost of the route from an ASBR to the destination

5.8.2 DHCP Relay Function

Basic Concept

DHCP Relay allows the OLT to forward DHCP packets between DHCP clients and the DHCP server that are in different network segments. DHCP clients can therefore obtain the IP addresses dynamically allocated by the DHCP server.

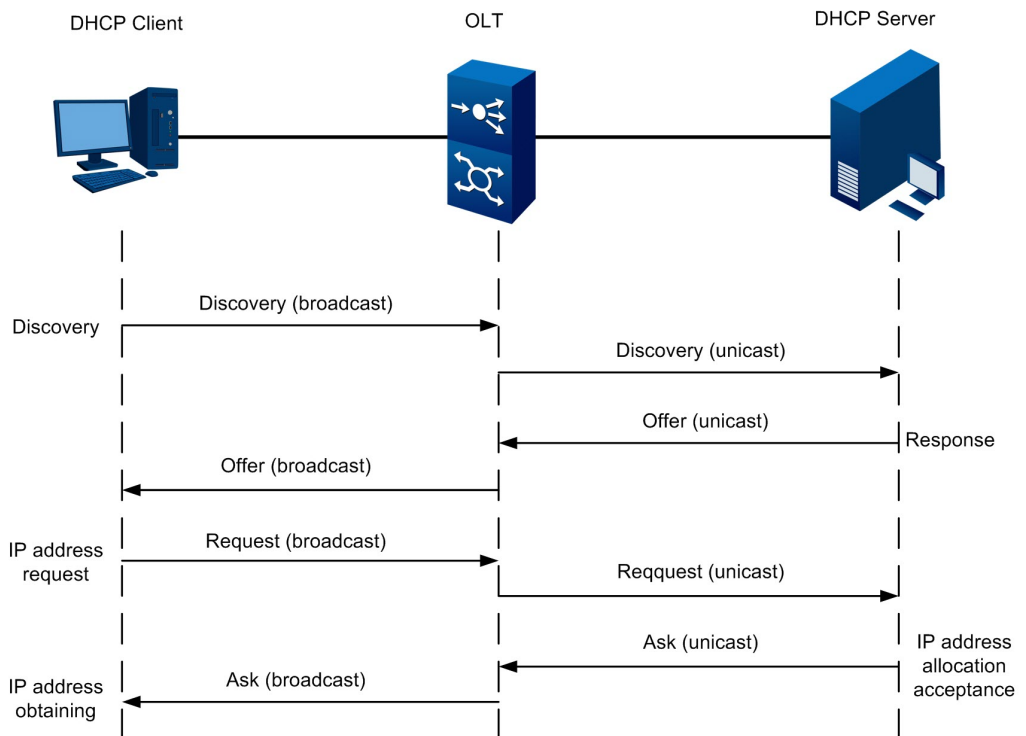

Application

If the DHCP relay feature is not supported, the DHCP protocol takes effect only when the DHCP clients and the DHCP server are in the same network segment. If they are in different network segments, each network segment requires a DHCP server, which increases deployment costs. The DHCP relay feature solves this issue. With this feature, one DHCP server can serve multiple DHCP clients in different network segments. This not only reduces deployment costs but also facilitates centralized management of the DHCP clients.

Network Diagram

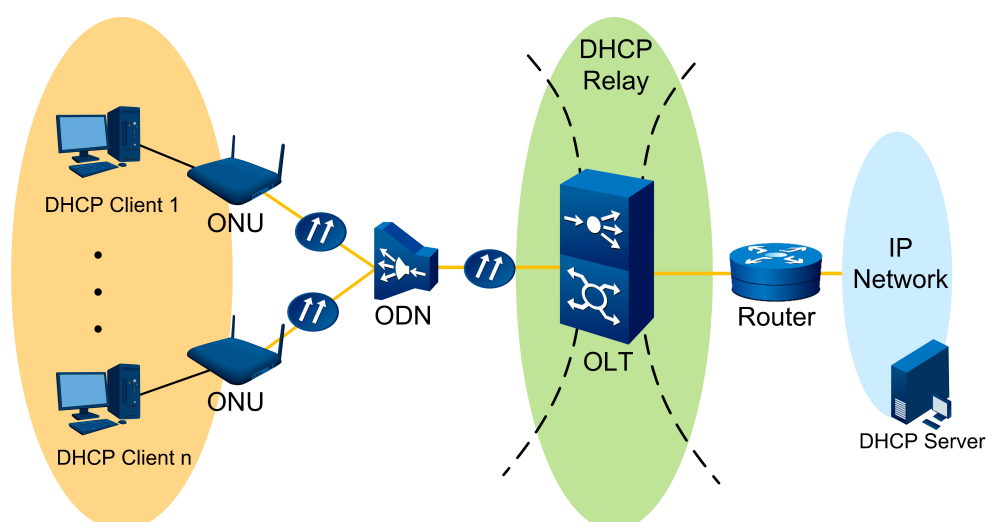

Highlight

- ◆ Enabling the DHCP Relay function based on VLAN: The DHCP Relay function is based on VLANIF. That is, the DHCP Relay can be enabled in a service VLAN, and the DHCP forwarding flow in other service VLANs will not be affected.
- ◆ Supporting the DHCP Option 60: A DHCP server group can be specified for users in different Option 60 domains identified by the DHCP Option60 fields.
- ◆ DHCP Option60 can be applied to user authentication, i.e., IPoE authentication.

Functions and Specifications

The table below lists the specifications of DHCP Relay supported by the equipment.

Function	Specification
DHCP Relay	Each DHCP Relay supports 16 DHCP servers.
	Up to 64 DHCPv4 Option 60 domains can be configured.

5.8.3 ARP Proxy Function

Basic Concept

The Address Resolution Protocol (ARP) is an Internet protocol to map IP addresses to MAC addresses. IP address is the network-layer address of a computer. To send network-layer data packets to the destination computer, the sending device must also know the physical address, i.e. MAC address of the destination computer. Accordingly, ARP is used to resolve a known IP address to a MAC address.

ARP Proxy is implemented as follows: A host sends an ARP request to another host located in the same network segment but not in the same physical network. Then the ARP Proxy-enabled device connected to the two hosts replies to the request. ARP Proxy allows isolated users in a VLAN or different Sub VLANs to communicate with each other. In this way, all the terminal equipment in the same network segment can communicate with each other. Meanwhile, the details of the physical network are unavailable, and the division of networks into subnets is transparent to hosts.

Application

- ◆ Enabling interconnection inside a PON: ARP Proxy allows user traffics to be forwarded and interconnected based on Layer 3 routing inside an OLT, so that isolated PON users can communicate with each other. ARP Proxy specially applies to service scenarios requiring interconnection such as voice services.
- ◆ Reducing upper-layer service flow and delay in network transmission: Layer 3 switching of local service flow can be implemented directly at the OLT to reduce the flow in the upper layer network.
- ◆ Simplifying network architecture: Layer 2 aggregation switches are not required, and this simplifies network architecture.
- ◆ Enhancing network security: The upper-layer network cannot learn MAC addresses on the user side, so that MAC spoofing and broadcast storm can be avoided.

Network Diagram

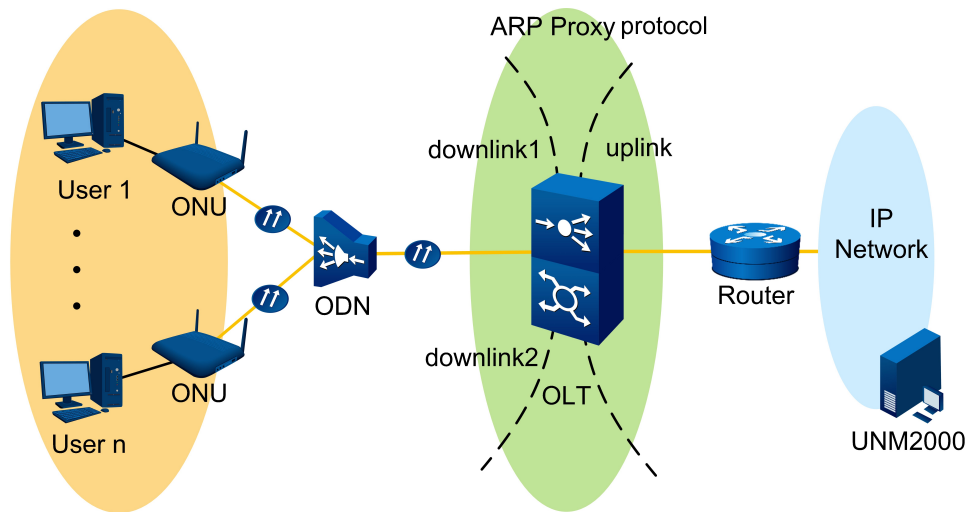

Highlight

- ◆ ARP Proxy can be enabled based on VLAN to allow intercommunication or isolation in different service scenarios.
- ◆ ARP Proxy can be configured based on any IP address, and this saves the IP address resource of the public network.
- ◆ ARP Proxy allows isolated users in a VLAN or different Sub VLANs to communicate with each other.

Functions and Specifications

Function	Specification
ARP Proxy	Supports enabling ARP Proxy based on VLAN.
	Supports ARP Proxy crossing network segments.
	Supports up to 16384 ARP entries.

5.9 Time and Clock Synchronization Function

Basic Concept

The concept of clock synchronization covers two aspects: time synchronization and frequency synchronization. Frequency synchronization is the basis for time synchronization. In the current mobile communication system, both the CDMA2000 and TD-SCDMA systems for 3G and the WiMAX/LTE system for 4G use the synchronous base station technology. High-precision time synchronization is required during BTS switching and roaming.

The equipment implements clock synchronization in multiple ways, as described in the table below.

Synchronization Mode	Description
E1	Applicable to the TDM service scenario.
BITS	BITS equipment need be deployed at each node.
1588 V2	The equipment supports 1588 V2, and can be applied to mobile communication scenarios in the CDMA2000, TD-SCDMA, WiMAX and LTE systems.
SyncE	The equipment should support SyncE.
1PPS+TOD	BITS equipment and GPS should be deployed at each node.

Application

The equipment supports high-precision time synchronization, and can be used as the bearer network for wireless backhaul. It can meet the rigorous requirements of mobile wireless system for clock synchronization in the backhaul network.

Table 5-1 Requirements for Clock Synchronization in Different Systems

Wireless System	Frequency Precision	Phase Synchronization Precision
GSM	0.05 ppm	-
WCDMA	0.05 ppm	-
TD-SCDMA	0.05 ppm	1.5 us
CDMA2000	0.05 ppm	3 us
WiMax FDD	0.05 ppm	-
WiMax TDD	0.05 ppm	1 us

Network Diagram

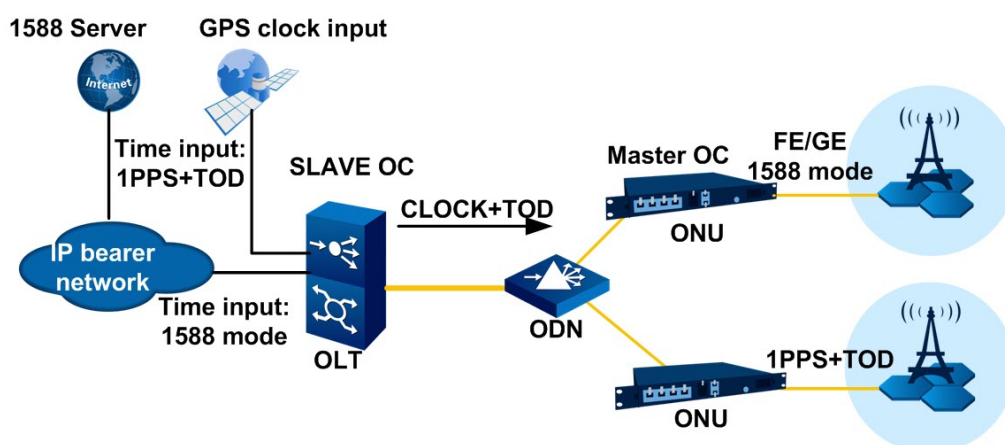

Highlight

- ◆ Supports the 1588 V2 function. Frequency synchronization with a precision of 50 ppb and time synchronization with a precision of 150 ns can be achieved to meet the requirements of mobile bearer network for synchronization.
- ◆ Provides various clock synchronization measures. Multiple clock sources can be used to trace and synchronize clock signals.

5.10 QoS Function

Basic Concept

QoS is the short form of quality of service. This function is applied to comprehensive scheduling of traffics for different services and users to ensure that the quality of services in the network is satisfactory to operators.

QoS is not a single technology, but a combination of multiple technologies such as priority processing, traffic policing, congestion control, traffic classification, and traffic shaping.

Indexes used to measure QoS include bandwidth, latency, jitter, packet loss rate, and so on.

HQoS is a technology to ensure bandwidth for multiple users and services using a hierarchical scheduling mechanism.

Application

- ◆ Enhancing bandwidth utilization rate: QoS can control network traffic in real time through appropriate allocation measures to make best use of bandwidth.
- ◆ Ensuring quality of key services: Ensure the quality of services for VIP customers through measures such as early drop and queue scheduling mechanism.
- ◆ Avoiding and controlling network congestion: Using the early-drop technology, QoS can actively drop packets with lower priority to save bandwidth for those with higher priority. When congestion occurs, a queue mechanism can be used to guarantee normal operation of services.
- ◆ Fair and differentiated services: QoS provides a fair competition mechanism for services of the same type and differentiated competition for services of different types. This enriches OAM measures for operators.
- ◆ Hierarchical scheduling: HQoS supports hierarchical scheduling based on services, ONUs and PON ports (while traditional QoS services can only be scheduled based on ports) so that operators can guarantee QoS for different user services, provide assured bandwidth and services for more users, and make more benefits.
- ◆ Management and scheduling for multiple users and services: HQoS supports unified management and hierarchical scheduling for multiple users and services to ensure their bandwidth.

Network Diagram

With abundant traffic classification rules, the AN6000 Series can precisely identify packets in a network, and map them to appropriate priorities. Through queue scheduling and traffic monitoring, bandwidth can be allocated reasonably to these packets to ensure stability of services. Besides that, hierarchical scheduling can be implemented based on traffic flows, ONUs, or PON ports.

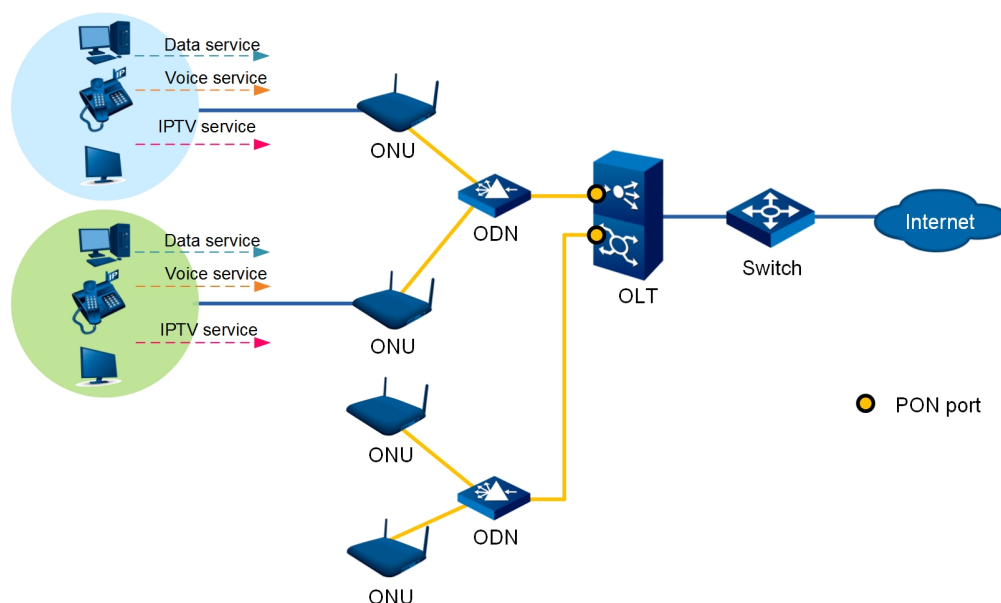

Figure 5-4 Hierarchical HQoS Network

Highlight

- ◆ Provides overall QoS mechanism. QoS control is implemented at each part of the service flow through measures such as traffic classification, priority, DBA, queue scheduling algorithm, and traffic control.
- ◆ Supports fine HQoS. Hierarchical scheduling and control of service flow allows fair allocation of bandwidth to users of the same retail service provider (RSP) or different RSPs.
- ◆ Supports the token bucket algorithm to restrict the rate of packets forwarded by service cards to the core switch card. This helps prevent service overload caused by traffic burst and enhances equipment security and reliability.
- ◆
- ◆ Controls congestion flexibly based on the CIR and PIR mechanisms.
- ◆ Supports traffic shaping to regulate network data transfer by delaying the flow of less important or less desired packets.

Functions and Specifications

Table 5-2 QoS Functions Supported by the Equipment

Item	Description
Priority mechanism	Supports marking inner / outer VLAN priorities, and supports designating, copying, converting and flexibly mapping priorities.
Traffic classification	Supports packet filtering and classification at an uplink port based on the source MAC address, destination MAC address, Ethernet type, VLAN, CoS, source IP address, destination IP address, IP port and protocol type.
Traffic policing	Supports traffic policing based on trTCM.
Port rate control	Supports rate control at ports.
Flow mirroring	Supports flow mirroring based on Ethernet data flow at uplink ports.
Congestion avoidance	Supports tail drop, early drop based on color, and intelligent flow scheduling.
Queue scheduling	Supports PQ, WRR, and PQ + WRR queue scheduling algorithms.
Hierarchical scheduling	Supports priority scheduling based on services, ONUs and PON ports.
Traffic shaping	Supports traffic shaping based on ONUs or queues. Supports dynamic adjustment of the output flow rate.

Table 5-3 QoS Capability for PON Access

Item	Access Type				
	EPON	10G EPON	GPON	XG-PON	XGS-PON
DBA profile quantity	1024	1024	1024	1024	1024
DBA function	Supports the dynamic bandwidth allocation (DBA) algorithm.		Supports uplink DBA and SBA; supports status report (SR) mode and non-status report (NSR) mode of DBA.		
CoS	Supports CoS Remark and CoS Copy, for example, modifies the original CoS value in user data packets or copy the CoS value from CVLAN to SVLAN.				
Classification of priority queues	Classifies priority queues according to the MAC address, 802.1p priority, 802.1Q VLAN ID, IP ToS, IP address and TCP / UDP address; supports maximally eight service levels.				
Number of priority queues at each port	8	8	8	8	8
Number of hierarchical scheduling levels (HQoS)	3	3	3	3	3
Multi-LLID technology	Supported	Supported	-	-	-
Multi-T-CONT technology	-	-	Each ONU supports up to eight T-CONTs.		

5.11 Reliability Function

This section introduces the reliability functions supported by the AN6000 Series, including equipment reliability protection, ERPS and MSTP.

5.11.1 Equipment Reliability

Basic Concept

The AN6000 Series provide the service overload control function and sound network protection solutions, including uplink protection, equipment protection, downstream PON link protection, and so on, to enhance the equipment reliability.

Application

The network protection function is applied to the access network as follows:

- ◆ Service overload control: Filters the packets sent to the core switch cards to prevent malicious attacks and transient service overload.
- ◆ Equipment protection: Switching can be implemented quickly in case of upgrade or failure to minimize influence on the network. The active and standby cards share load between them with bandwidth doubled.
- ◆ Protection on the uplink network side: Allows load balancing, port protection, link switching, and fast convergence on the uplink side through the Trunk, LACP, MSTP and ERPS functions, to ensure the network side security.
- ◆ Protection on the downlink access side: Provides Type B / Type C redundancy protection for ODNs and ONUs with low cost, simple technology, and high reliability.

Network Diagram

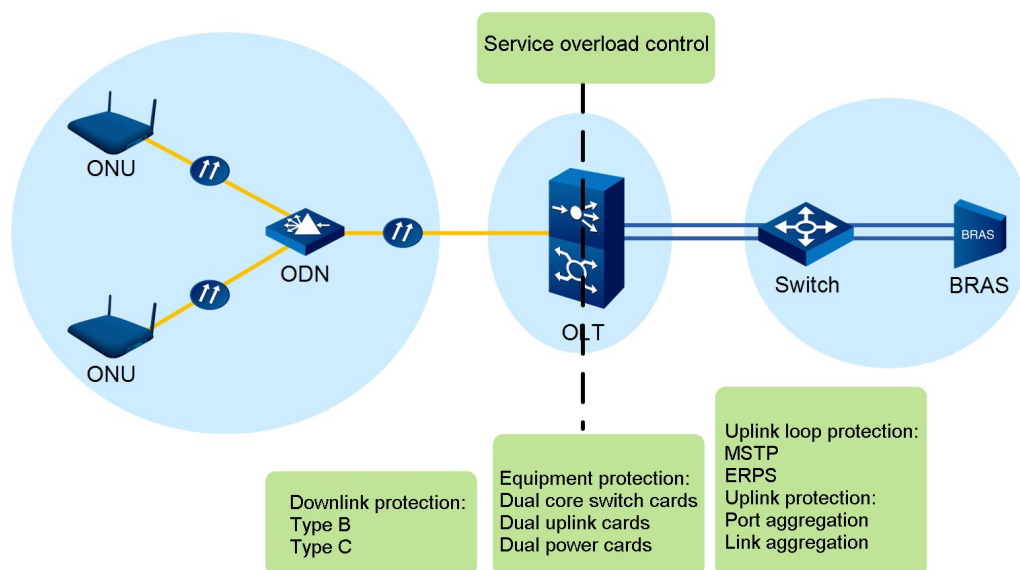

Highlight

- ◆ Service overload control: Prevents the services carried by the equipment from being interrupted and from going out of control of the EMS, and guarantees the quality of the services with higher priority when the equipment system resources are overloaded.
- ◆ Hardware redundancy: Quick switching is implemented in case of failure; dual main control cards ensure that service will not be interrupted during upgrade.
- ◆ Ring network protection scheme: Featured by good interworking and fast convergence with switching time no more than 50 ms.
- ◆ Ethernet link aggregation: Both intra-card and inter-card aggregations are supported with the switching time no more than 50 ms.
- ◆ Ethernet port protection group (uplink redundancy protection): Supports protection between ports, protection group in an aggregation group, and inter-card protection.
- ◆ Type B protection for PON ports of the equipment: Both intra-card and inter-card protection are supported, with the switching time less than 50 ms. During switching, the ONU need not re-register at the OLT, and the configuration data of the ONU will be automatically synchronized at the new working port.
- ◆ Type C protection for PON ports of the equipment: Both single-homing and dual-homing protection can be implemented.

Functions and Specifications

Function	HSCA	HU8A	GPOA	EX8A	EXOA	GX8A	GM8A	GMOA	GNOA
Intra-card aggregation	√	√	×	×	×	×	×	×	×
Inter-card aggregation	√	√	×	×	×	×	×	×	×
Type B	×	×	√	√	√	√	√	√	√
Type C	×	×	√	√	√	√	√	√	√
1+1 load sharing and forwarding	√	√	√	√	√	√	√	√	√
Note 1: "√" indicates "supported"; "×" indicates "not supported".									

5.11.2 ERPS Function

Basic Concept

ERPS is a kind of network protection technology based on Ethernet ring. The ERPS protocol is used to control the port status and thereby protect the ring network automatically. The protection switching can be completed in a short time. For this reason, the ERPS is widely used in networks.

Application

- ◆ Redundancy backup or load balancing for links can be easily implemented to prevent broadcast storm caused by data loop.
- ◆ Provides independent protection for different services through multiple instances.
- ◆ The convergence time is irrelevant with the number of nodes in the ring network. ERPS has better performance in convergence than traditional STP in complicated networks.
- ◆ Supports automatic control to lower maintenance work load.

Network Diagram

As illustrated in the figure below, three OLTs make up an ERPS ring. The ring has two ERPS ring instances, which correspond to two kinds of services on the user side respectively. For different ring instances, the OLT ports can be set to different blocking states. As shown in the figure, two service flows come into being to share the load on links.

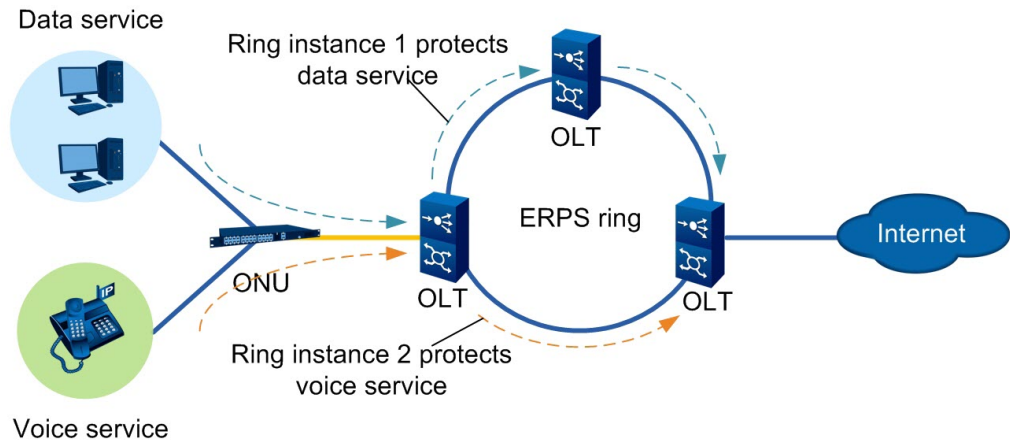

Highlight

- ◆ Detects traffics in two directions.
- ◆ Supports the Polling mechanism. The master node on the ERPS ring sends probe messages to detect the ring network state actively.
- ◆ Provides the link-state-change notification mechanism. The transit node monitors the ports and links on the current node, and notifies the master node immediately when the port or link state changes. In this way, the logical link can adapt to the network change as soon as possible.
- ◆ Supports protection switching at the millisecond level for fast convergence.

Functions and Specifications

Item	Description
Protocol version	Supports the G.8032 V1 protocol, which is compatible with the G.8032 V2 protocol nodes.
Service protection scope	Protects Layer 2 services, multicast services, and Layer 3 services.
Network mode	Supports both single ERPS ring and ERPS rings interconnected through one node. Multiple instances can run on the rings.

Item	Description
Quantity of ring instances	Supports maximally 64 instances.
Port reusability	Every port can join two ERPS rings.
Application of link aggregation	The owner port of a link aggregation group can be configured as a node on the ERPS ring.
Switching time	When all the ports on the ERPS ring are optical ports, the protection switching can be implemented within 100 ms (the working mode of Ethernet ports can be set to "forced" or "auto-negotiation").

5.11.3 MSTP Function

Basic Concept

In the Layer 2 switched network, a loop in the network will cause infinite loop and proliferation of packets, which leads to broadcast storm and occupies all bandwidth available so that the network becomes unusable. As defined by the IEEE 802.1s, the Multiple Spanning Tree Protocol (MSTP) is compatible with STP and RSTP, and can compensate for the defects of them.

Application

The MSTP is applied to the access network as follows:

- ◆ The MSTP features fast convergence, and allows the traffics in different VLANs to be forwarded along their own paths, so as to provide a better load balancing mechanism for redundancy links.
- ◆ The MSTP prunes a loop network into a loop-free tree network. This helps avoid infinite loop and proliferation of packets.

Network Diagram

A, B and C are the OLT equipment running the MSTP in the MST region, and C is the root of the region.

Each MST region may have multiple spanning trees (MST). Each spanning tree corresponds to a spanning tree instance (STI), and multiple spanning trees correspond to multiple spanning tree instances (MSTI). In this network diagram, VLAN 10 is mapped into MST 1, and other VLANs are mapped into MST 0.

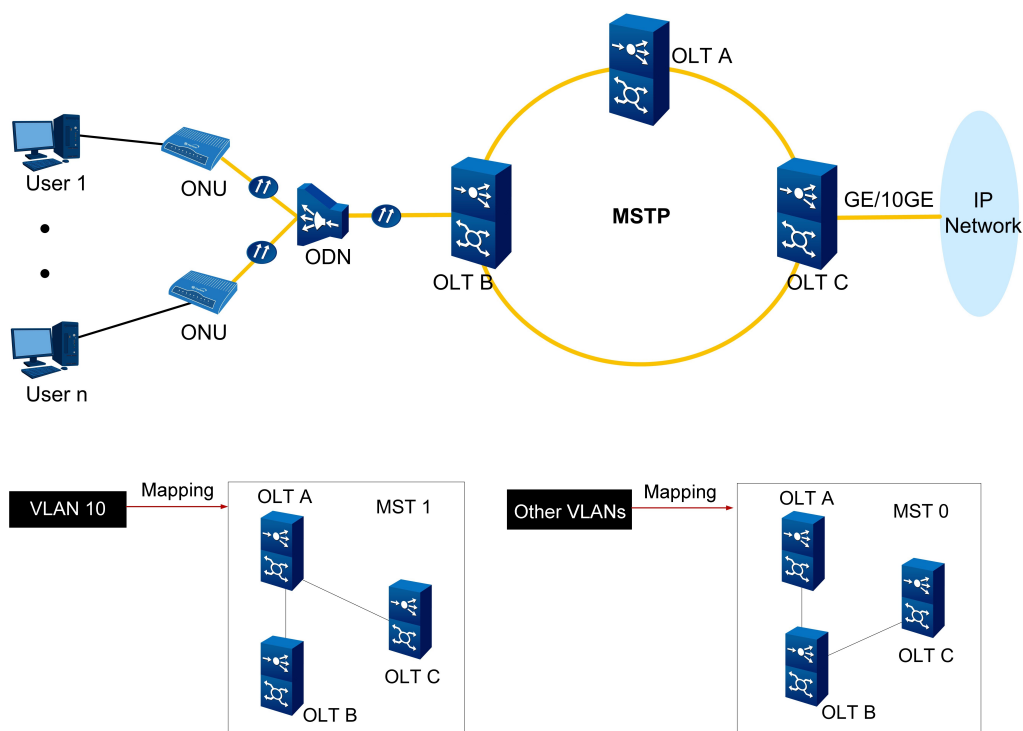

Highlight

- ◆ BPDU protection: protects the bridge against malicious attacks, which may cause network change.
- ◆ Root protection: In case of incorrect configurations or malicious network attacks, a legal root bridge may become a non-root bridge; accordingly, the network topology changes and causes network congestion. The root protection function is a solution for this problem.
- ◆ Loop protection: restricts the loop congestion.
- ◆ Ethernet port protection group (uplink redundancy protection): Supports protection between ports, protection group in an aggregation group, and inter-card protection.
- ◆ The PON ports of the equipment support Type B protection: Both intra-card and inter-card protection are supported, with the switching time less than 50 ms. During switching, the ONU need not re-register at the OLT, and the configuration data of the ONU will be automatically synchronized on the new working port.

- ◆ The PON ports of the equipment support Type C protection. Both single-homing and dual-homing protection can be implemented.

Functions and Specifications

Function	Specification
MSTP	Supports the BPDU protection.
	Supports the Root protection.
	Supports the loop protection.
	Compatible with RSTP/STP.
	The system has one region.
	The system supports altogether 64 instances (one CIST + 63 MSTIs).
	The convergence time is less than 250 ms (depending on the number of nodes involved)
	Supports mapping of VLAN (1 to 4094) instances.
	The system has no restriction on the number of nodes in a ring network. It is recommended to use no more than 10 nodes.

5.12 Security Function

Basic Concept

The AN6000 Series are designed with carrier-class reliability to guarantee the security of equipment, data, and maintenance operations on the equipment in the system. Protocols and functions such as AAA, SSH, and protection against DoS attacks are supported.

- ◆ Protection against DoS attacks: Protects against denial of service (DoS) attacks. Protects network security by identifying, intercepting and dropping illegal packets.

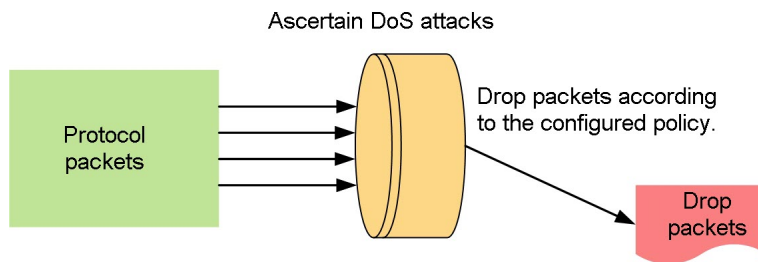

- ◆ AAA: Authentication, Authorization and Accounting. A remote authentication protocol (e.g. RADIUS and TACACS) is used to authenticate a user according to the interaction protocol packets between the client end and the authorization server. In this process, certain rights are authorized to the user if he / she passes the authentication.
- ◆ SSH: Secure Shell (SSH) is formulated by the IETF Network Working Group to provide security for remote login session and other network services. Through the steps including version negotiation, key exchange, and user authentication, an SSH secure channel is set up. Any data transfer protocol can transfer data in this channel.

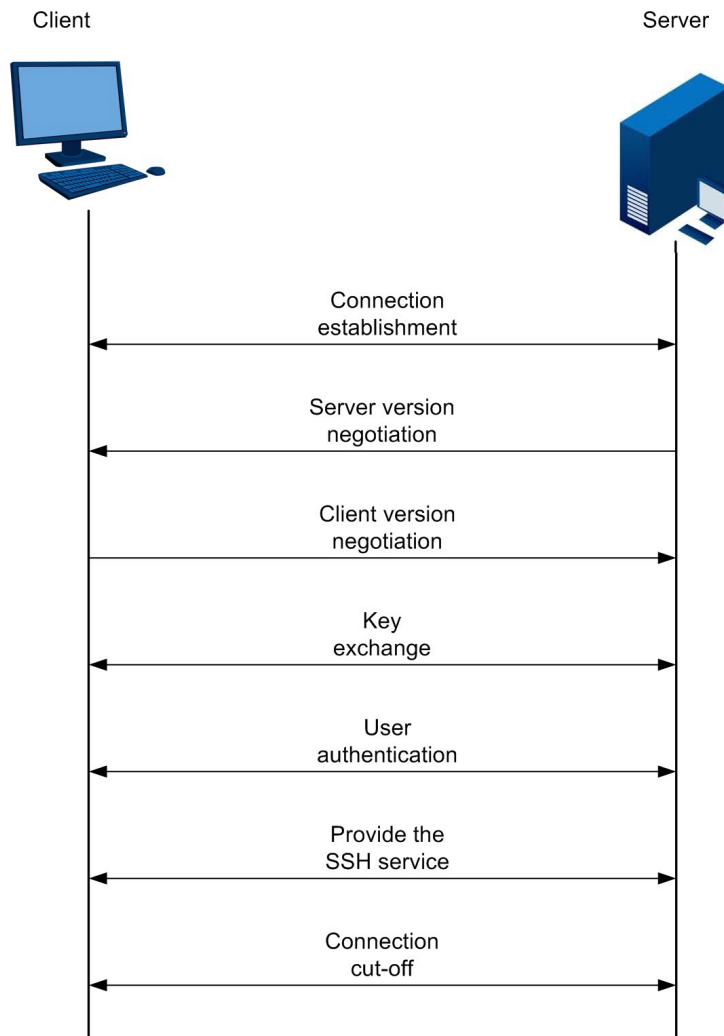

Application

The equipment security functions are applied in the following aspects:

- ◆ System protection: Intercepts DoS attack packets at the OLT side, which helps prevent DoS attacks from affecting user services.
- ◆ Data protection: Security measures including authentication, authorization and accounting are taken to enhance the security of equipment in the network. The operation authority for users can be flexibly controlled, and operations of users can be recorded.

- ◆ Security protection for operation and maintenance: Unlike conventional network service programs that transmit data in plain text over the network, SSH encrypts data to be transferred to prevent the data from being divulged or attacked by DNS or IP address spoofing. During encryption, the data are compressed to a smaller size, so that they can be transferred at a higher rate. This ensures high bandwidth, security and line quality, and lowers the maintenance cost.

Network Diagram

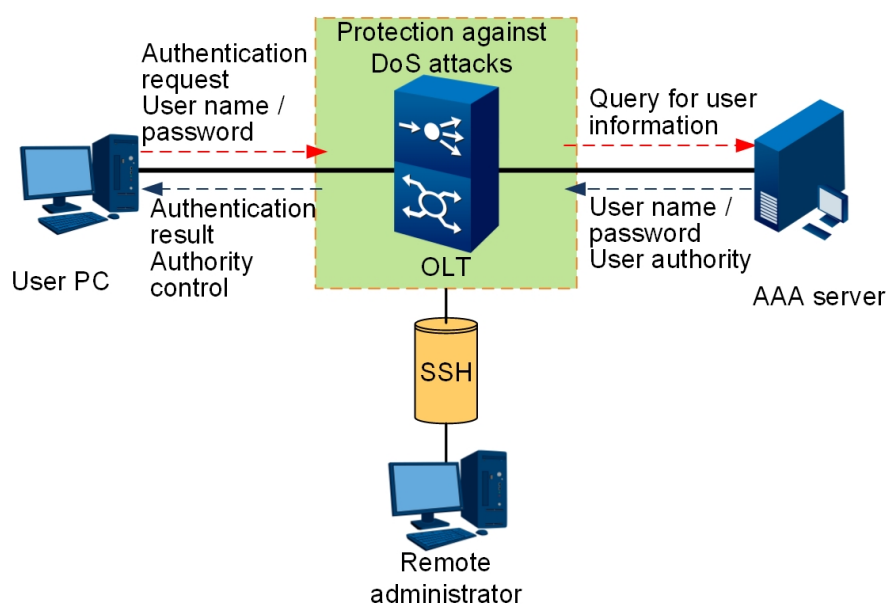

Highlight

- ◆ Anti-DoS attack black list: The users who have launched DoS attacks will be included in the blacklist, and the system will force them to go off line.
- ◆ Policies against DoS packet attacks: Resolves and intercepts DoS packets. After the protection against DoS attacks is enabled, the equipment will ascertain the attacking packets according to their features and drop them accordingly.
- ◆ AAA: Both TACACS and RADIUS protocols provide the authentication, authorization and accounting (AAA) functions. The client-server mode is used in both protocols, and the public key is used to encrypt the user information transferred, which is flexible and scalable.

- ◆ SSH: Concurrent SSH logins, multiple authentication modes, and multiple encryption and key algorithms are supported.

Functions and Specifications

In the anti-DoS mechanism, the packets with the following features will be reckoned as the attacking packets and dropped.

No.	Packet Feature
1	The source MAC address is the same with the destination MAC address.
2	The source IP address is the same with the destination IP address.
3	The source and destination port numbers of the UDP packets are the same.
4	The source and destination port numbers of the TCP packets are the same.
5	The length of TCP header is smaller than the minimum value (configurable in the range between 0 and 255, with the default value of 20 bytes).
6	The TCP is fragmented with the deviation value 1.
7	The source port number of the TCP SYN packets ranges between 0 and 1023 (TCP_SYNErrror: SYN = 1, and SRC_Port < 1024. The packet is not fragmented or is the first one to be fragmented.)
8	The control flag of the TCP packet is 0, and the sequence number is 0 as well.
9	The SYN and FIN values of the TCP packet are both 1.
10	The FIN, URG and PSH values of the TCP packet are 1, and the sequence number of the packet is 0.
11	Fragmented ICMP packet
12	Extra long ICMP V4 ping packet (the packet length is configurable: the maximum length is 16 KB, and the default length is 512 bytes.)
13	Extra long ICMP V6 ping packet (the packet length is configurable: the maximum length is 16 KB, and the default length is 512 bytes.)

The table below describes the functional differences between the protocols TACACS and RADIUS.

TACACS Protocol	RADIUS Protocol
TCP is used, and the network transmission is more reliable.	UDP is used, and the network transmission is more efficient.
Except the header, all the other parts of the TACACS packet are encrypted.	Only the password field in the authentication packet is encrypted.

TACACS Protocol	RADIUS Protocol
The protocol packet is complicated. The authentication and authorization are separated, so that authentication and authorization services can be implemented on different servers.	The protocol packet is simple, and the authentication and authorization are integrated.
Supports authorized use of configuration commands on the equipment. The command lines available to users are restricted by both user levels and AAA authorization. Each command entered by a user at a certain level needs to be authorized by the TACACS server. Only authorized commands can be executed.	Authorized use of configuration commands on the equipment is not supported. The command lines available to a user after he / she logs in to the equipment depend on the user level. The user can only use the command lines whose default level is equal to or lower than the user level.

The table below describes the SSH functions and specifications.

Function	Specification
Protocol	Supports the SSH 2.0 protocol.
Authentication mode	Supports password authentication and key authentication. Local CLI account authentication, TACACS authentication, and RADIUS authentication can be applied to password authentication.
Host key algorithm	ssh-rsa and ssh-dss
Key exchange algorithm	diffie-hellman-group-exchange-sha1, diffie-hellman-group14-sha1 and diffie-hellman-group1-sha1
MAC message digest algorithm	hmac-md5, hmac-sha1, hmac-ripemd160, hmac-ripemd160@openssh.com, hmac-sha1-96 and hmac-md5-96
Encryption algorithm	aes128-cbc, 3des-cbc, blowfish-cbc, cast128-cbc, arcfour128, arcfour256, arcfour, aes192-cbc, aes256-cbc, rijndael-cbc@lysator.liu.se, aes128-ctr, aes192-ctr and aes256-ctr
Compression algorithm	Zlib compression

5.13 Maintenance and Management Function

This section introduces the maintenance and management functions supported by the AN6000 Series, including flexible port mirroring, emulation, and the network management system UNM2000.

5.13.1 Maintenance Function

Basic Concept

The AN6000 Series supports flexible port mirroring and emulation tests for multiple services to enable quick isolation of faults.

- ◆ Flexible port mirroring: Determines traffic features according to traffic classification, and mirrors the data traffic with specified features to designated ports. The feature parameters can be flexibly defined, including but not limited to the packets' SMAC, DMAC, SIP, DIP, protocol type, VLAN ID, PON port (only applicable to the uplink egress direction), and ONU (only applicable to the uplink egress direction).
- ◆ Remote mirroring: Encapsulates mirrored data and sends them to a remote server.
- ◆ DHCP emulation: In a DHCP emulation test, an OLT simulates a DHCP Client to conduct remote tests or isolate faults for services that obtain IP addresses in DHCP mode (such as IPTV, Internet access, and voice services).
- ◆ PPPoE emulation: In a PPPoE dial-up emulation test, an OLT emulates an end user and initiates PPPoE dial-up. According to the PPPoE emulation test result (succeeded or failed), the maintenance engineers can check the connectivity between the access equipment and the broadband remote access server (BRAS), and determine whether services connected in PPPoE mode are normal.
- ◆ Multicast emulation: In a multicast emulation test, an OLT remotely emulates an end user going online. The maintenance engineers query the real-time traffic of the multicast program to determine whether the multicast function is normal.

Application

- ◆ By virtue of port mirroring, the packets with specified features can be precisely mirrored to the destination port and then service traffic data packets can be captured for analysis to facilitate fault detection.
- ◆ In remote mirroring, mirrored data are encapsulated and sent to a remote server to facilitate fault detection.

- ◆ The emulation test is mainly applied to scenarios such as commissioning test, acceptance inspection, and fault isolation. Unlike traditional measures, service emulation tests can be implemented remotely. The test personnel need not go to the site to operate fibers or equipment. All they need to do is to enable the emulation test function via the CLI or GUI network management system. Then the configuration data will be verified and faults will be located. This will visibly improve the efficiency of acceptance inspection and troubleshooting, and lower the cost of equipment maintenance.

Network Diagram

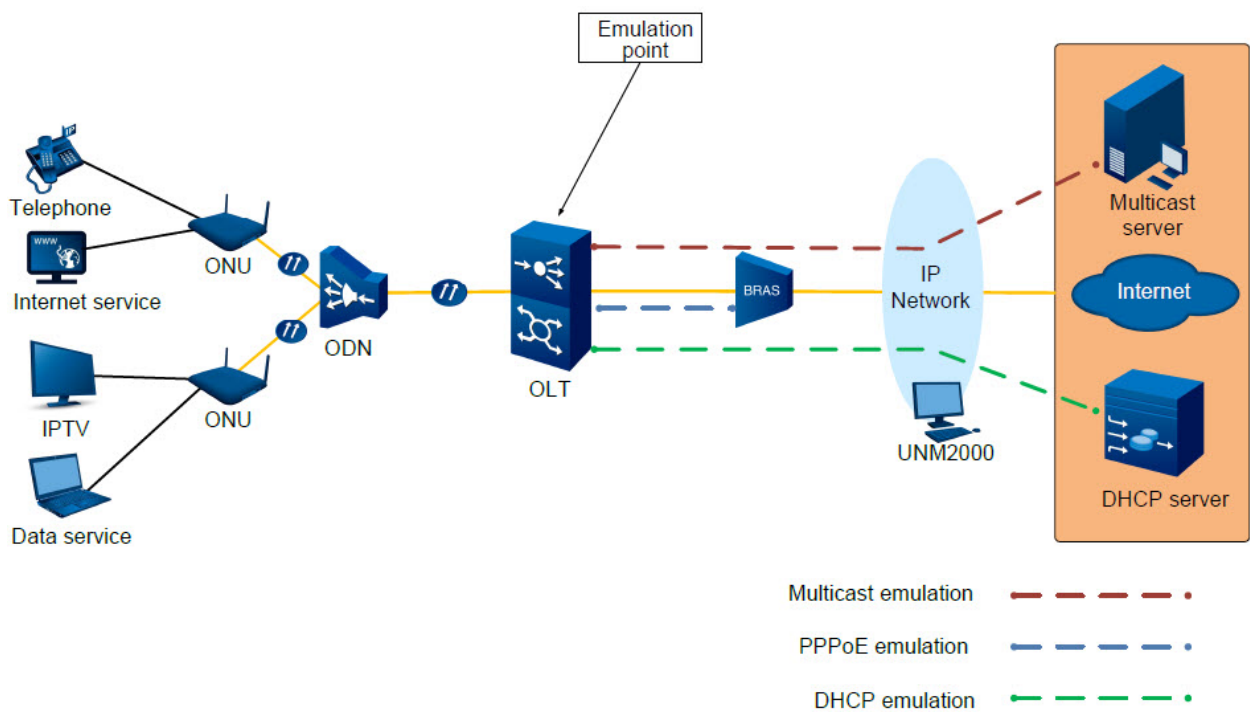

Highlight

The service emulation function provided by the equipment has the highlights as follows:

- ◆ Implements service emulation tests remotely. The test result helps ascertain whether services can be started normally.
- ◆ Determines the network segment where the fault is located, analyzes causes of the fault according to the result of the emulation test, and takes measures accordingly.

Functions and Specifications

Function	Specification
Port mirroring	Supports mirroring based on PON ports and ONUs.
	Supports remote mirroring.
	Supports concurrent mirroring of 4 service flows.

5.13.2 Network Management Function

Basic Concept

The AN6000 Series can be managed by a GUI network management system (the UNM2000) or a CLI (command line interface) network management system. The UNM2000 is the major means for network management, and it can be networked in two modes as follows:

- ◆ In-band network mode: The management information is transmitted over the service channel. The uplink card ports are shared for management and service. This helps save the cost for carriers. However, the communication between the network management system and the managed equipment will be interrupted when the service channel fails.
- ◆ Out-of-band network mode: The management information is transmitted over a non-service channel. The management channel is separated from the service channel, and is more reliable than that in the in-band mode. However, the management channel requires independent ports, and this brings higher cost in network construction.

Application

- ◆ The network management system provides common network management functions (such as management of configurations, performance, alarms, security, logs, topology and system) and many optional functions for the AN6000 Series. The EMS is scalable and easy to operate.
- ◆ The network management function helps improve working efficiency and lower operational cost.

Network Diagram

The figure below shows the typical network diagram (in-band) for managing the AN6000 Series through the UNM2000.

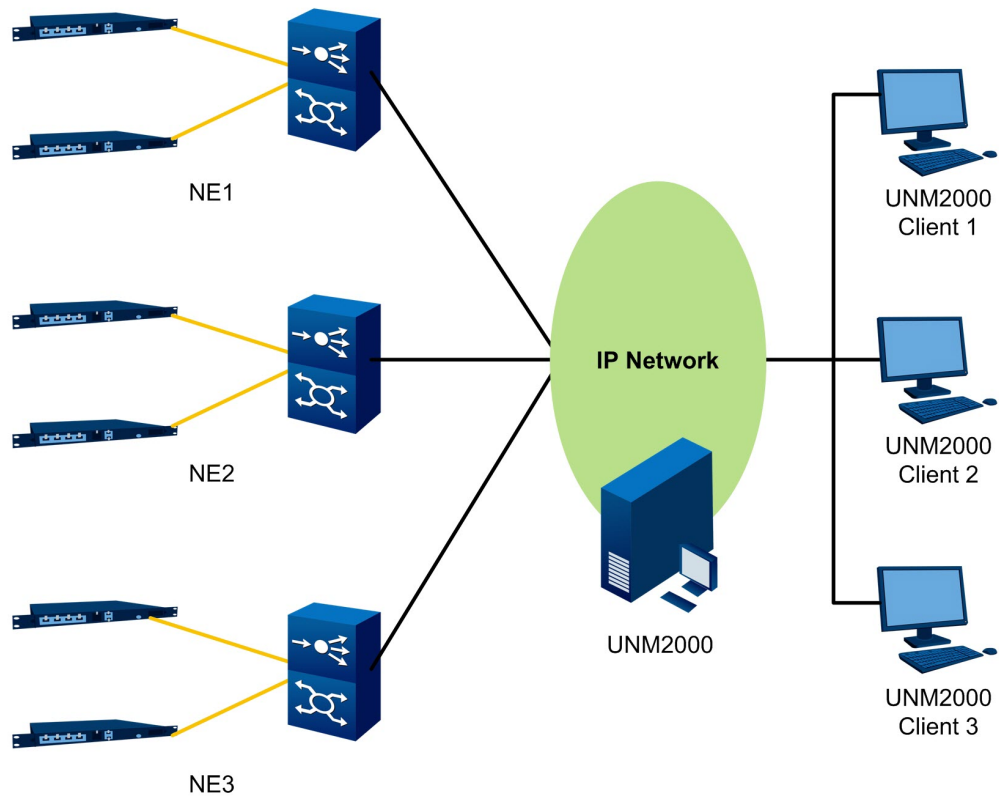

Highlight

- ◆ Supports four deployment modes: collective deployment with a single host, distributed deployment with a single system, collective deployment with cluster for disaster discovery, and distributed deployment with cluster for disaster discovery.
- ◆ Controls the functions and management capability of the UNM2000 via License to satisfy varied demands of customers.
- ◆ Provides friendly graphic user interfaces and simplified logging mode for easy operation.
- ◆ Provides modularized software for flexible customization. The software modules can be upgraded and maintained independently.

Functions and Specifications

Table 5-4 System Performance of the UNM2000

Item	Specification
Time for starting up the network management system	< 10 min
Time for shutting down the network management system	< 10s
Number of concurrent client ends	≥ 100
Maximum number of NEs under management	100 000
Maximum number of users supported	500
Maximum number of user groups supported	50
Maximum number of object groups supported	100
Maximum number of operation groups supported	255

Table 5-5 Hardware Configuration Requirements for the Server End

Network Scale	CPU Clock Rate	CPU Quantity	Memory Size	Hard Disk Space	Hardware Format	Network Card
Equivalent to more than 1000 OLTs fully configured with ONUs	Intel E7-8837 (8-core), 2.6 GHz	4	64 GB	4*600 GB	The disks planned for the database and the network management system (Disks C and D respectively by default) should be in the NTFS format.	Embedded GE dual-port dual-network card
Equivalent to 500 to 1000 OLTs fully configured with ONUs	Intel Xeon E7-4610V2 (8-core), 2.3 GHz	4	32 GB	4*600 GB	The disks planned for the database and the network management system (Disks C and D respectively by default) should be in the NTFS format.	Embedded GE dual-port dual-network card

Table 5-5 Hardware Configuration Requirements for the Server End (Continued)

Network Scale	CPU Clock Rate	CPU Quantity	Memory Size	Hard Disk Space	Hardware Format	Network Card
Equivalent to 100 to 500 OLTs fully configured with ONUs	Intel Xeon E5-2430V2 (8-core), 3.3 GHz	2	32 GB	2*600 GB	The disks planned for the database and the network management system (Disks C and D respectively by default) should be in the NTFS format.	Embedded GE dual-port dual-network card
Equivalent to less than 100 OLTs fully configured with ONUs	Intel Xeon E5-2407V2 (6-core), 2.5 GHz	2	16 GB	2*600 GB	The disks planned for the database and the network management system (Disks C and D respectively by default) should be in the NTFS format.	Embedded GE dual-port single-network card

Table 5-6 Software Configuration Requirements for the Server End

Configuration Item	Requirement
Operating system	Windows Server 2008 R2 Standard 64-bit
	SUSE Linux Enterprise11 64-bit
	Solaris 11 64-bit
Database	SQL Server 2008 R2
	MySQL 5.6
JRE	JRE 1.6.0

Table 5-7 Hardware Configuration Requirements for the Client End

Network Scale	CPU Clock Rate	CPU Quantity	Memory Size	Hard Disk Space	Hardware Format	Graphics Card
Equivalent to more than 1000 OLTs fully configured with ONUs	Intel Xeon E5-2637V2 (4-core), 3.5 GHz	1	16 GB	1*2 TB	The disk planned for the network management system (Disk D by default) should be in the NTFS format.	1 GB discrete graphics
Equivalent to 500 to 1000 OLTs fully configured with ONUs	Intel i3-4130 (dual-core), 3.4 GHz	1	8 GB	1*1 TB	The disk planned for the network management system (Disk D by default) should be in the NTFS format.	1 GB discrete graphics
Equivalent to 100 to 500 OLTs fully configured with ONUs	Intel Core i5-4200U (1.6G-2.6G/3M) (dual-core), 3.4 GHz	1	8 GB	1*500 GB	The disk planned for the network management system (Disk D by default) should be in the NTFS format.	nVIDIA GT720M, 1 GB discrete graphics
Equivalent to less than 100 OLTs fully configured with ONUs	Intel Core i5-4200U (1.6G-2.6G/3M) (dual-core), 3.4 GHz	1	4 GB	1*500 GB	The disk planned for the network management system (Disk D by default) should be in the NTFS format.	Intel HD 4400 integrated graphics card

Table 5-8 Software Configuration Requirement for the Client End

Configuration Item	Requirement
Operating system	Windows 7/Windows 8/Windows 10
JRE	JRE 1.6.0

6 Product Structure

This chapter introduces the logical architecture and software architecture of the AN6000 Series.

- Logical Architecture
- Software Architecture

6.1 Logical Architecture

The figure below shows the logical architecture of the AN6000 Series.

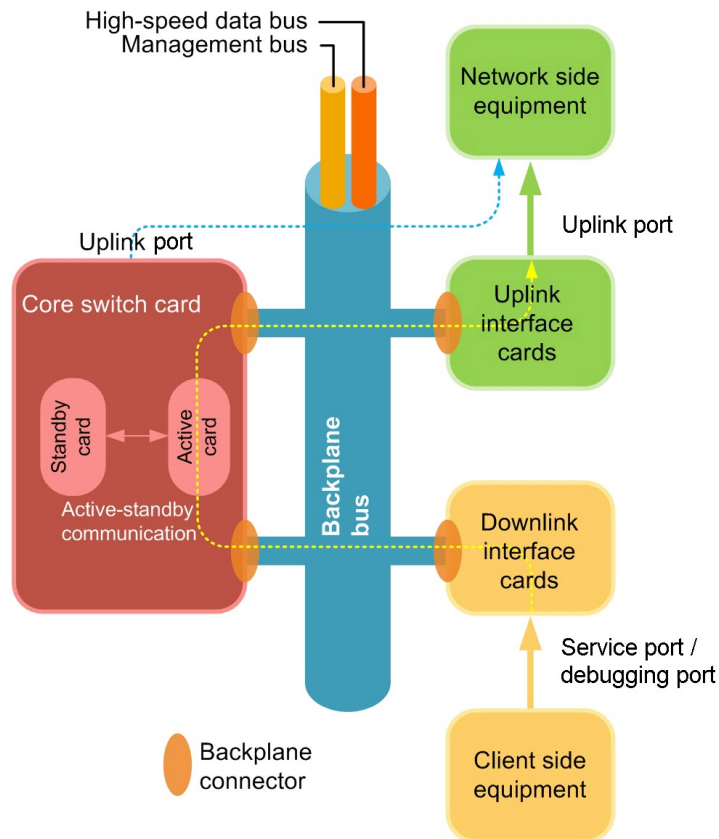

The cards communicate with each other via the backplane buses (combination of the data bus and management bus) interconnected at high speed to exchange service data or management information.

The figure above covers the cards as follows:

Classification	Coverage	Description
Core switch card	-	<ul style="list-style-type: none"> ◆ Two cards of the same model form card redundancy. The active card and the standby card communicate with each other, and are connected to the backplane bus respectively. ◆ Connects to the upstream equipment, and provides 10GE uplink optical ports.
Interface card in the uplink direction	Uplink card	Connects to the upstream equipment, and provides 10GE and other type of uplink optical ports.
Interface card in the downlink direction	PON service cards	<ul style="list-style-type: none"> ◆ Provides various PON ports for the downstream equipment. ◆ The data on service cards are aggregated by the core switch card and then transmitted to the upper layer network via uplink ports.

6.2 Software Architecture

The figure below illustrates the software system of the AN6000 Series.

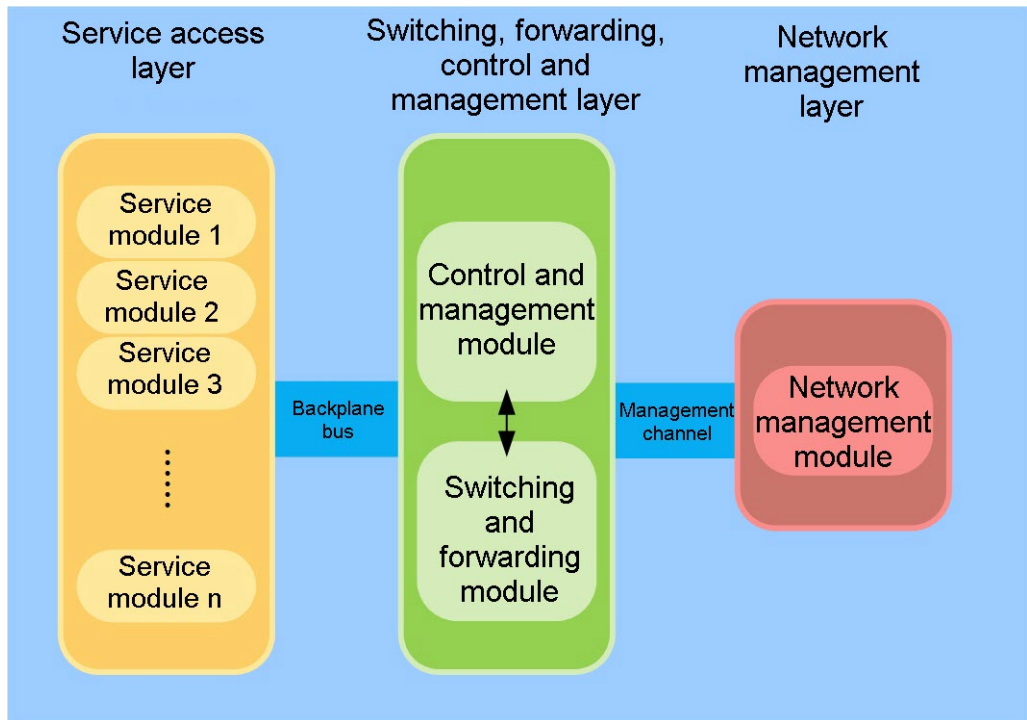

- ◆ Service access layer: Covers the software residing on the service cards; communicates with the switching, forwarding, control and management layer via the backplane bus.
- ◆ Switching, forwarding, control and management layer: Resides on the core switch card and uplink card, and includes the control and management module and the switching and forwarding module. Responsible for equipment management and maintenance, the control and management module provides the management and maintenance interface for the network management module; the switching and forwarding module provides the uplink port, monitors the port status, and informs the control and management module of the status.
- ◆ Network management layer: Runs on the network management server, and provides the interface for network management operations. The network management module communicates with the control and management module via the SNMP.

7

Standards and Protocols

This chapter introduces the international standards, operators' standards and communications protocols followed by the AN6000 Series.

- Environment Standards
- EMC Standards
- Safety Standards
- Standards for PON Access
- Standards and Protocols for Services
- Standards for Network Protection
- Standards for Layer 3 Functions
- Other Standards

7.1 Environment Standards

Standard Number	Title
ETSI EN 300 019-1-1	Environmental Engineering (EE); Environmental conditions and environmental tests for telecommunications equipment; Part 1-1: Classification of environmental conditions: Storage Class 1.1: Weatherprotected, partly temperature-controlled storage locations Class 1.2: Weatherprotected, not temperature-controlled storage locations
ETSI EN 300 019-1-2	Environmental Engineering (EE); Environmental conditions and environmental tests for telecommunications equipment; Part 1-2: Classification of environmental conditions: Transportation Class 2.1: Very careful transportation Class 2.2: Careful transportation
ETSI EN 300 019-1-3	Environmental Engineering (EE); Environmental conditions and environmental tests for telecommunications equipment; Part 1-3: Classification of environmental conditions; Stationary use at weatherprotected locations Class 3.1: Temperature-controlled locations Class 3.2: Partly temperature-controlled location
IEC 60068-2	Basic Environmental Testing Procedures
IEC 60721-2-6	Environmental conditions appearing in nature - Earthquake vibration
IEC 60721-3-1	Classification of environmental conditions - Part 3: Classification of groups of environmental parameters and their severities - Section 1: Storage
IEC 60721-3-3	Classification of environmental conditions - Part 3: Classification of groups of environmental parameters and their severities - Section 3: Stationary use at weatherprotected locations
ETSI EN 300 753	Equipment Engineering (EE); Acoustic noise emitted by telecommunications equipment
NEBS GR-63-CORE	Network Equipment-Building System (NEBS) Requirements: Physical Protection
ROHS	Restriction of the use of certain hazardous substance in electrical and electronic equipment.
ANSI/UL 94-2006	Tests for Flammability of Plastic Materials for Parts in Devices and Appliances (Proposal dated March 17, 2006)
BS EN 60950-1-2006	Information technology equipment - Safety - General requirements
BS EN 60950-22-2006	Information technology equipment - Safety - Equipment installed outdoors
IEC 60917-1	Modular order for the development of mechanical structures for electronic equipment practices - Part 1: Generic standard
IEC 60917-1-amd1	Amendment 1 - Modular order for the development of mechanical structures for electronic equipment practices - Part 1: Generic standard

Standard Number	Title
IEC 60917-2	Modular order for the development of mechanical structures for electronic equipment practices - Part 2: Sectional specification - Interface co-ordination dimensions for the 25 mm equipment practice
IEC 60917-2-1	Modular order for the development of mechanical structures for electronic equipment practices - Part 2: Sectional specification - Interface co-ordination dimensions for the 25 mm equipment practice - Section 1: Detail specification - Dimensions for cabinets and racks
IEC 60917-2-2	Modular order for the development of mechanical structures for electronic equipment practices - Part 2: Sectional specification - Interface co-ordination dimensions for the 25 mm equipment practice - Section 2: Detail specification - Dimensions for subracks, chassis, backplanes, front panels and plug-in units
IEC 60917-2-3	Modular order for the development of mechanical structures for electronic equipment practices - Part 2-3: Sectional specification - Interface co-ordination dimensions for the 25 mm equipment practice - Extended detail specification - Dimensions for subracks, chassis, backplanes, front panels and plug-in units
IEC 60950-22-2005	Information technology equipment - Safety - Part 22: Equipment to be installed outdoors
IEC 61587-1-2007	Mechanical structures for electronic equipment - Tests for IEC 60917 and IEC 60297 - Part 1: Climatic, mechanical tests and safety aspects for cabinets, racks, subracks and chassis
IEC 61587-2-2000	Mechanical structures for electronic equipment - Tests for IEC 60917 and IEC 60297 - Part 2: Seismic tests for cabinets and racks
IEC 61587-3-2006	Mechanical structures for electronic equipment - Tests for IEC 60917 and IEC 60297 - Part 3: Electromagnetic shielding performance tests for cabinets, racks and subracks
UL 94-1996	UL Standard for Safety Test for Flammability of Plastic Materials for Parts in Devices and Appliances Fifth Edition
ETS 300 253	Earthing and bonding of telecommunication equipment in telecommunication centres
GR 1089 CORE	Electromagnetic Compatibility and Electrical Safety - Generic Criteria for Network Telecommunications Equipment

7.2 EMC Standards

Standard Number	Title
CISPR 32	Information technology equipment - Radio disturbance characteristics - Limits and methods of measurement
CISPR 24	Information technology equipment - Immunity characteristics - Limits and methods of measurement

Standard Number	Title
IEC 61000-3-2	Electromagnetic compatibility - Limits - Limits for harmonic current emissions (equipment input current ≤ 16 A per phase)
IEC 61000-3-3	Electromagnetic compatibility- Limits - Limitation of voltage changes, voltage fluctuation and flicker in public low-voltage supply systems, for equipment with rated current ≤ 16 A per phase and not subject to conditional connection
IEC 61000-4-2	Electromagnetic compatibility - Testing and measurement techniques - Electrostatic discharge immunity test
IEC 61000-4-3	Electromagnetic compatibility - Testing and measurement techniques - Radiated, radio-frequency, electromagnetic field immunity test
IEC 61000-4-4	Electromagnetic compatibility - Testing and measurement techniques - Electrical fast transient/burst immunity test
IEC 61000-4-5	Electromagnetic compatibility - Testing and measurement techniques - Surge immunity test
IEC 61000-4-6	Electromagnetic compatibility - Testing and measurement techniques - Immunity to conducted disturbances, induced by radio-frequency fields
IEC 61000-4-8	Electromagnetic compatibility - Testing and measurement techniques - Power frequency magnetic field immunity test
IEC 61000-4-11	Electromagnetic compatibility - Testing and measurement techniques - Voltage dips, short interruption and voltage variations immunity tests
EN 55032	Electromagnetic compatibility of multimedia equipment - Emission Requirements
EN 55024	Information technology equipment - Immunity characteristics - Limits and methods of measurement
EN 61000-3-2	Electromagnetic compatibility - Limits - Limits for harmonic current emissions (equipment input current ≤ 16 A per phase)
EN 61000-3-3	Electromagnetic compatibility- Limits - Limitation of voltage changes, voltage fluctuation and flicker in public low-voltage supply systems, for equipment with rated current ≤ 16 A per phase and not subject to conditional connection
EN 61000-4-2	Electromagnetic compatibility - Testing and measurement techniques - Electrostatic discharge immunity test
EN 61000-4-3	Electromagnetic compatibility - Testing and measurement techniques - Radiated, radio-frequency, electromagnetic field immunity test
EN 61000-4-4	Electromagnetic compatibility - Testing and measurement techniques - Electrical fast transient/burst immunity test
EN 61000-4-5	Electromagnetic compatibility - Testing and measurement techniques - Surge immunity test
EN 61000-4-6	Electromagnetic compatibility - Testing and measurement techniques - Immunity to conducted disturbances, induced by radio-frequency fields

Standard Number	Title
EN 61000-4-8	Electromagnetic compatibility - Testing and measurement techniques - Power frequency magnetic field immunity test
EN 61000-4-11	Electromagnetic compatibility - Testing and measurement techniques - Voltage dips, short interruption and voltage variations immunity tests
ETSI EN 300386	Electromagnetic compatibility and Radio spectrum Matters (ERM); Telecommunication network equipment; Electro-Magnetic Compatibility (EMC) requirements
ITU-T K.20	Resistibility of telecommunication equipment installed in customer premises to overvoltages and overcurrents
ITU-T K.45	Resistibility of telecommunication equipment installed in the access and trunk networks to overvoltages and overcurrents
ITU-T K.21	Resistibility of telecommunication equipment installed in customer premises to overvoltages and overcurrents
ITU-T K.44	Resistibility tests for telecommunication equipment exposed to overvoltages and overcurrents - Basic Recommendation
ITU-T K.27	Bonding configuration and earthing inside a telecommunication building

7.3 Safety Standards

Standard Number	Title
IEC 60950-1	Information Technology Equipment - Safety - Part 1: General Requirements
EN 60950-1	Information Technology Equipment - Safety - Part 1: General Requirements
UL 60950-1	Information Technology Equipment - Safety - Part 1: General Requirements
CAN/CSA-C22.2 No 60950-1	Information Technology Equipment - Safety - Part 1: General Requirements
IEC 60825-1	Safety of laser products - Part 1: Equipment classification, requirements and user's guide
IEC 60825-2	Safety of laser products - Part 2: Safety of optical fibre communication systems
EN 60825-1	Safety of laser products - Part 1 : Equipment classification and requirements and user's guide
EN 60825-2	Safety of laser products - Part 2: Safety of optical fibre communication systems
73/23/EEC (Europe)	Low Voltage Directive

7.4 Standards for PON Access

EPON Standards

Standard Number	Title
DSL Forum TR-069	CPE WAN Management Protocol
DSL Forum WT-142	Framework for TR-069 enabled PON devices (Revision 3)
IEEE 802.3-2005	IEEE Standard for Information technology–Telecommunications and information exchange between systems–Local and metropolitan area networks–Specific requirements Part 3: Carrier Sense Multiple Access with Collision Detection (CSMA/CD) Access Method and Physical Layer Specifications

GPON Standards

Standard Number	Title
ITU-T G.984.1	Gigabit-capable passive optical networks (GPON): General characteristics
ITU-T G.984.2	Gigabit-capable Passive Optical Networks (GPON): Physical Media Dependent (PMD) layer specification
ITU-T G.984.3	Gigabit-capable Passive Optical Networks (G-PON): Transmission convergence layer specification
ITU-T G.Imp984.3	Implementers' Guide for ITU-T Rec. G.984.3 (02/2004)
ITU-T G.984.4	Gigabit-capable passive optical networks (G-PON): ONT management and control interface specification
ITU-T G.Imp984.4	Implementor's Guide for ITU-T Rec. G.984.4
ITU-T G.984.5	Enhancement band for gigabit capable optical access networks
ITU-T G.984.6	Gigabit-capable passive optical networks (GPON): Reach extension
ITU-T G.988	ONU management and control interface (OMCI) specification

10G EPON Standards

Standard Number	Title
IEEE 802.3av-2009	IEEE Standard for Information technology - Telecommunications and information exchange between systems - Local and metropolitan area networks - Specific requirements Part 3:Carrier Sense Multiple Access with Collision Detection (CDMA/CD) access mode and Physical Layer Specifications Amendment 1: Physical Layer Specifications and Management Parameters for 10 Gb/s Passive Optical Networks

XG-PON Standards

Standard Number	Title
ITU-T G.987	ITU-T Recommendation G.987 (2010), G.987 definitions, abbreviations and acronyms
ITU-T G.987.1	ITU-T Recommendation G.987.1 (2009), 10 Gigabit-capable Passive Optical Network (XG-PON): General Requirements
ITU-T G.987.2	ITU-T Recommendation G.987.2 (2009), 10 Gigabit-capable Passive Optical Network (XG-PON): Physical Media Dependent (PMD) layer Specification
ITU-T G.987.3	XG-PON TC Layer Specification
ITU-T G.988	ITU-T Recommendation G.988 (2010), ONU management and control interface specification (OMCI)

XGS-PON Standards

Standard Number	Title
ITU-T G.9807.1	10-Gigabit-capable symmetric passive optical network (XGS-PON)

7.5 Standards and Protocols for Services

Protocols for IMS Voice Service

Standard Number	Title
3GPP TS 23.228	IP Multimedia Subsystem (IMS)
3GPP TS 24.228	Signaling Flows for the IP Multimedia Call Control based on SIP and SDP
3GPP TS 24.229	IP Multimedia Call Control Protocol based on SIP and SDP

Protocols for NGN Voice Service

Standard Number	Title
ITU-T G.711	Pulse code modulation (PCM) of voice frequencies
ITU-T G.711.1	Wideband embedded extension for G.711 pulse code modulation
ITU-T G.723.1	Dual rate speech coder for multimedia communications transmitting at 5.3 and 6.3 kbit/s
ITU-T G.729	Coding of speech at 8 kbit/s using conjugate-structure algebraic-code-excited linear prediction (CS-ACELP)
ITU-T G.729.1	G.729 based Embedded Variable bit-rate coder: An 8-32 kbit/s scalable wideband coder bitstream interoperable with G.729
ITU-T G.Imp729	Implementers' Guide for G.729 Annexes B, F, G, I and C+ (Coding of speech at 8 kbit/s using CS-ACELP)

Standard Number	Title
RFC 3261	SIP: Session Initiation Protocol
RFC 2327	SDP: Session Description Protocol
RFC 3262	Reliability of Provisional Responses in the Session Initiation Protocol (SIP)
RFC 4028	Session Timers in the Session Initiation Protocol (SIP)
RFC 3525	Gateway Control Protocol Version 1
RFC 3015	Megaco Protocol Version 1.0
ITU-T H.248.1	Gateway control protocol: Version 3
RFC 3389	Real-time Transport Protocol (RTP) Payload for Comfort Noise (CN)
ITU-T T.30	Procedures for document facsimile transmission in the general switched telephone network
ITU-T T.38	Procedures for real-time Group 3 facsimile communication over IP networks
RFC 3550	A Transport Protocol for Real-Time Applications
RFC 3611	RTP Control Protocol Extended Reports (RTCP XR)
ITU-T Q.23	Technical features of push-button telephone sets
ITU-T Q.24	Multifrequency push-button signal reception
ITU-T E.180	Technical characteristics of tones for the telephone service
RFC 2833	RIP Payload for DTMF Digits, Telephony Tones and Telephony Signals
RFC 2198	RTP Payload for Redundant Audio Data
ITU-T G.168	Digital network echo cancellers

Protocols for Multicast Service

Standard Number	Title
IETF RFC 1112	Host Extensions for IP Multicasting
IETF RFC 2236	Internet Group Management Protocol, Version 2
IETF RFC 3376	Internet Group Management Protocol, Version 3
IETF RFC 2710	Multicast Listener Discovery (MLD) for IPv6
IETF RFC 3810	Multicast Listener Discovery Version 2 (MLDv2) for IPv6

Time Standards

Standard Number	Title
IEEE 1588-2008	IEEE Standard for a Precision Clock Synchronization Protocol for Networked Measurement and Control Systems
IETF RFC 1305	Network Time Protocol (Version 3) Specification, Implementation and Analysis

Standard Number	Title
IETF RFC 2030	Simple Network Time Protocol (SNTP) Version 4 for IPv4, IPv6 and OSI
G.984.3-Amendment 2	Time-of-day distribution and maintenance updates and clarifications

Ethernet Protocols

Standard Number	Title
IEEE 802-2001	IEEE Standard for Local and Metropolitan Area Networks: Overview and Architecture
IEEE 802.1ad	IEEE Standard for Local and Metropolitan Area Networks - Virtual Bridged Local Area Networks - Amendment 4: Provider Bridges
IEEE 802.1ag-2007	IEEE Standard for Local and Metropolitan Area Networks Virtual Bridged Local Area Networks Amendment 5: Connectivity Fault Management
IEEE 802.1w-2001	Local and metropolitan area networks - Common specifications - Part 3: Media access control (MAC) bridges; Amendment 2: Rapid reconfiguration
IEEE 802.1x-2004	IEEE Standard for Local and Metropolitan Area Networks Port-Based Network Access Control
IEEE 802.1D-2004	IEEE Standard for Local and metropolitan area networks: Media Access Control (MAC) Bridges
IEEE 802.1Q-2005	IEEE Standard for Local and Metropolitan Area Networks - Virtual Bridged Local Area Networks - Amendment 4: Provider Bridges
IEEE 802.3ah	IEEE Standard for Information technology- Telecommunications and information exchange between systems - Local and metropolitan area networks - Specific requirements Part 3: Carrier Sense Multiple Access with Collision Detection (CSMA/CD) Access Method and Physical Layer Specifications Amendment: Media Access Control Parameters, Physical Layers, and Management Parameters for Subscriber Access Networks
IEEE 802.1s-2002	IEEE Standards for Local and metropolitan area networks - Virtual Bridged Local Area Networks - Amendment 3: Multiple Spanning Trees
ITU-T Y.1291	An architectural framework for support of Quality of Service in packet networks
TR-101	Migration to Ethernet-Based DSL Aggregation
IEEE 802.1ag	Connectivity Fault Management, IEEE Standard for Local and Metropolitan Area Networks Virtual Bridged Local Area Networks Amendment 5

7.6 Standards for Network Protection

Reference Standard for Ethernet Link Aggregation

Standard Number	Title
IEEE 802.1AX-2008	IEEE Standard for Local and metropolitan area networks - Link Aggregation

Reference Standard for MSTP

Standard Number	Title
IEEE Std 802.1d	1998 Edition, Spanning Tree Protocol
IEEE Std 802.1w-2001	Rapid Spanning Tree Protocol
IEEE Std 802.1s-2002	Multiple Spanning Tree Protocol

Reference Standard for ERPS

Standard Number	Title
ITU-T G.8032 V1	Ethernet Ring Protection Switching
ITU-T G.8032 V2	Ethernet Ring Protection Switching

7.7 Standards for Layer 3 Functions

Reference Standard for ARP

Standard Number	Title
IETF RFC 826	An Ethernet Address Resolution Protocol or Converting Network Protocol Addresses to 48.bit Ethernet Address for Transmission on Ethernet Hardware

Reference Standard for ARP Proxy

Standard Number	Title
IETF RFC 1027	Using ARP to Implement Transparent Subnet Gateways

Reference Standard for DHCP Relay

Standard Number	Title
RFC 2131	Dynamic Host Configuration Protocol

Reference Standard for DHCP Proxy

Standard Number	Title
dsl2006[1].127.00	Proposals of DHCP relay improvements

Routing Protocols

Standard Number	Title
IETF RFC 1723	RIP Version 2 Carrying Additional Information
IETF RFC 2453	RIP Version 2

7.8 Other Standards

Standard Number	Title
IETF RFC 2284	PPP Extensible Authentication Protocol (EAP)
SFF-8472	Specification for Diagnostic Monitoring Interface for Optical Transceivers (Rev 10.3 Dec.1, 2007)
ITU-T Rec L.40	Optical fibre outside plant maintenance support, monitoring and testing system
ITU-T Rec L.53	Optical fibre maintenance criteria for access networks
IETF RFC 2362	Protocol Independent Multicast-Sparse Mode

8 Abbreviations

AAA	Authentication, Authorization and Accounting
ACL	Access Control List
ARP	Address Resolution Protocol
AS	Autonomous System
ASBR	Autonomous System Boundary Router
BHCA	Busy Hour Call Attempts
BITS	Building Integrated Timing Supply
BPDU	Bridge Protocol Data Unit
BRAS	Broadband Remote Access Server
CDMA	Code Division Multiple Access
CDR	Call Detail Record
CIR	Committed Information Rate
CIST	Common and Internal Spanning Tree
CoS	Class of Service
CPE	Customer Premises Equipment
CPU	Central Processing Unit
DBA	Dynamic Bandwidth Assignment
DDF	Digital Distribution Frame
DHCP	Dynamic Host Configuration Protocol
DoS	Denial of Service
DSL	Digital Subscriber Line
EMC	Electro Magnetic Compatibility
EPON	Ethernet Passive Optical Network
ERPS	Ethernet Ring Protection Switching
FEC	Forward Error Correction
FTTB	Fiber To The Building
FTTC	Fiber To The Curb
FTTH	Fiber To The Home
FTTM	Fiber To The Mobile
FTTO	Fiber To The Office
GEM	GPON Encapsulation Mode
GPON	Gigabit-capable Passive Optical Network
GPS	Global Positioning System

GSM	Global System for Mbile communications
HG	Home Gateway
HQoS	Hierarchical Quality of Service
ICMP	Internet Control Message Protocol
IGMP	Internet Group Management Protocol
IMS	IP Multimedia Subsystem
IP	Internet Protocol
IPoE	Internet Protocol over Ethernet
IPTV	Internet Protocol TeleVision
IPv4	Internet Protocol version 4
IPv6	Internet Protocol version 6
ISDN	Integrated Services Digital Network
ISP	Internet Service Provider
JRE	Java Runtime Environment
LACP	Link Aggregation Control Protocol
LAN	Local Area Network
LLDP	Link Layer Discovery Protocol
MAC	Medium Access Control
MDF	Main Distribution Frame
MDI	Media Delivery Index
MDU	Multi-Dwelling Unit
MGC	Media Gateway Controller
MLD	Multicast Listener Discovery
MoIP	Modem over IP
MOS	Mean Opinion Score
MST	Multiple Spanning Tree
MSTI	Multiple Spanning Tree Instance
MSTP	Multiple Spanning Tree Protocol
MTBF	Mean Time Between Failure
MTU	Multi-Tenant Unit
NGN	Next Generation Network
NP	Network Processor
NTFS	New Technology File System
OAM	Operation, Administration and Maintenance
ODN	Optical Distribution Network
OLT	Optical Line Terminal
ONU	Optical Network Unit

OSPF	Open Shortest Path First
P2P	Point-To-Point service
PADI	PPPoE Active Discovery Initiation
PADR	PPPoE Active Discovery Request
PDP	Power Distribution Panel
PIR	Peak Information Rate
PLR	Packet Loss Rate
PON	Passive Optical Network
POTS	Plain Old Telephone Service
ppb	part per billion
ppm	part per million
PPPoE	Point to Point Protocol over Ethernet
PPPoE+	Point to Point Protocol over Ethernet plus
PPS	Pulses Per Second
PQ	Priority Queue
PSQM	Perceptual Speed Quality Measure
QinQ	802.1Q-in-802.1Q
QoS	Quality of Service
RADIUS	Remote Authentication Dial In User Service
RIP	Routing Information Protocol
RSP	Retail Service Provider
RSSI	Received Signal Strength Indicator
RSTP	Rapid Spanning Tree Protocol
RTP	Real-time Transport Protocol
SBA	Static Bandwidth Assignment
SBU	Single Business Unit
SDH	Synchronous Digital Hierarchy
SFU	Single Family Unit
SIP	Session Initiation Protocol
SNI	Service Node Interface
SNMP	Simple Network Management Protocol
SSH	Secure Shell
STP	Straight-Through Processing
SYN	SYNchronous idle character
TACACS	Terminal Access Controller Access Control System
TCP	Transmission Control Protocol

TDM	Time Division Multiplexing
TD-SCDMA	Time Division-Synchronous Code Division Multiple Access
TOD	Time Of Day
ToS	Type of Service
TrTCM	Two Rate Three Color Marker
UDP	User Datagram Protocol
UNI	User Network Interface
VIP	Very Important Person
VLAN	Virtual Local Area Network
VNI	VXLAN Network Identifier
VoIP	Voice over Internet Protocol
VS	Virtual System
VTEP	VXLAN Tunnel End Point
VXLAN	Virtual eXtensible Local Area Network
WCDMA	Wideband Code Division Multiple Access
WDM	Wavelength Division Multiplexing
WFQ	Weighted Fair Queuing
WiMAX	Worldwide Interoperability for Microwave Access
WRED	Weighted Random Early Detection
WRR	Weighted Round Robin
XG-PON	10-Gigabit-capable Passive Optical Network
XGS-PON	10-Gigabit-capable Symmetric Passive Optical Network

Product Documentation Customer Satisfaction Survey

Thank you for reading and using the product documentation provided by FiberHome. Please take a moment to complete this survey. Your answers will help us to improve the documentation and better suit your needs. Your responses will be confidential and given serious consideration. The personal information requested is used for no other purposes than to respond to your feedback.

Name	
Phone Number	
Email Address	
Company	

To help us better understand your needs, please focus your answers on a single documentation or a complete documentation set.

Documentation Name	
Code and Version	

Usage of the product documentation:

1. How often do you use the documentation?

Frequently Rarely Never Other (please specify) _____

2. When do you use the documentation?

in starting up a project in installing the product in daily maintenance in trouble shooting Other (please specify) _____

3. What is the percentage of the operations on the product for which you can get instruction from the documentation?

100% 80% 50% 0% Other (please specify) _____

4. Are you satisfied with the promptness with which we update the documentation?

Satisfied Unsatisfied (your advice) _____

5. Which documentation form do you prefer?

Print edition Electronic edition Other (please specify) _____

Quality of the product documentation:

1. Is the information organized and presented clearly?

Very Somewhat Not at all (your advice) _____

2. How do you like the language style of the documentation?

Good Normal Poor (please specify) _____

3. Are any contents in the documentation inconsistent with the product?

4. Is the information complete in the documentation?

Yes

No (Please specify) _____

5. Are the product working principles and the relevant technologies covered in the documentation sufficient for you to get known and use the product?

Yes

No (Please specify) _____

6. Can you successfully implement a task following the operation steps given in the documentation?

Yes (Please give an example) _____

No (Please specify the reason) _____

7. Which parts of the documentation are you satisfied with?

8. Which parts of the documentation are you unsatisfied with? Why?

9. What is your opinion on the Figures in the documentation?

Beautiful Unbeautiful (your advice) _____

Practical Unpractical (your advice) _____

10. What is your opinion on the layout of the documentation?

Beautiful Unbeautiful (your advice) _____

11. Thinking of the documentations you have ever read offered by other companies, how would you compare our documentation to them?

Product documentations from other companies: _____

Satisfied (please specify) _____

Unsatisfied (please specify) _____

12. Additional comments about our documentation or suggestions on how we can improve:

Thank you for your assistance. Please fax or send the completed survey to us at the contact information included in the documentation. If you have any questions or concerns about this survey please email at

edit@fiberhome.com